



OWL WATERPROOFING

THE WISE CHOICE

MASTER DOC: TDS, SDS, APPLICATION GUIDELINE, SPECIFICATIONS



TABLE OF CONTENT

Lava 20 System Introduction	1
Lava 20 System on Different Substrates	2 - 3
Lava 20 System Detailed Drawing	4 - 15
Different Projects with Lava 20	16 - 25
Lava 20 Quick Step By Step Guide	26
Lava 20 Application Specification	27 - 32
Lava 20 Application Guideline	33 - 55
Technical Data Sheet (TDS)	56 - 98
Safety Data Sheet (SDS)	99 - 313

LAVA 20 SYSTEM

The Durable, Versatile & Flexible Liquid Rubber Waterproofing System For Flat or Low Pitched Roofs, Balconies, Decks & Terraces etc.

Uses & Benefits

- Cost Effective
- Flexible / High Elasticity
- Ponding Water Resistant
- Withstands All Temperatures (Freezing & Hot)
- Chemical Resistant
- Seamless / No Joints
- Versatile
- Bonds to Almost Everything
- Vapour Permeable (Breathable)
- Easy Detailing
- Maintenance Free
- Fast & Easy to Apply
- UV Resistant
- 25 Year Warranty
- Highly Durable
- Optional Anti - Slip Finish
- BBA & CE Certified
- Highly Fire Rated
- Remains Flexible in All Temperatures

LAVA 20 SYSTEM BONDS TO ALMOST ALL SURFACES

- Timber (OSB / Plywood)
- Asphalt*
- Torch Down Felt (BUR)*
- Concrete
- Tiles
- Insulation
- Cement Boards
- Metals
- Single Ply
- Spray Foam
- Asbestos
- GRP
- Existing Coatings (Except Silicone)

*Requires Matting

LAVA 20 SYSTEM ON DIFFERENT SUBSTRATES

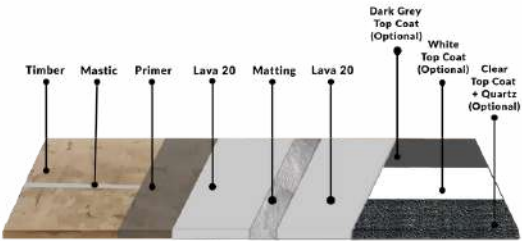

Timber

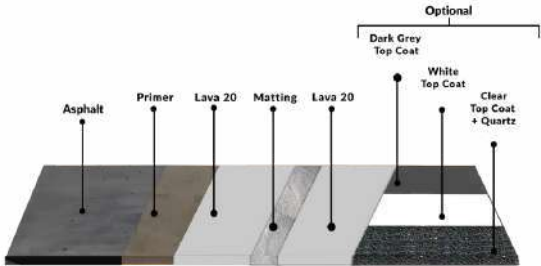

Asphalt

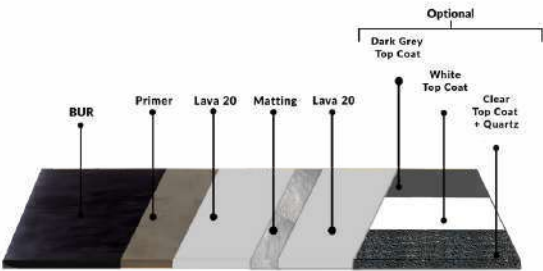

Torch Down Felt (BUR)

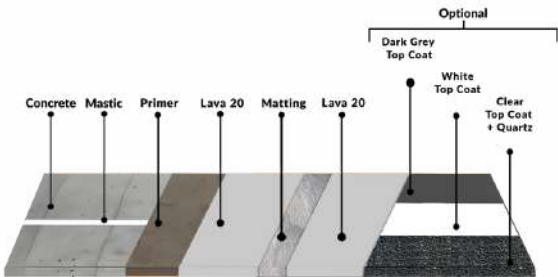

Concrete

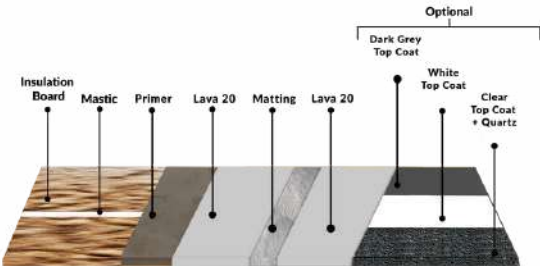

Insulation Board

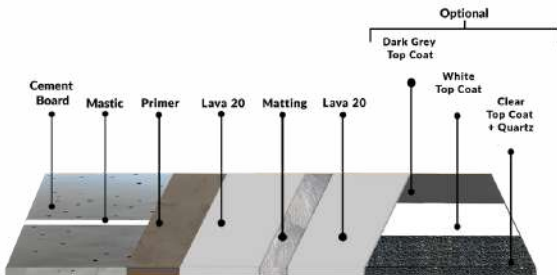

Cement Board

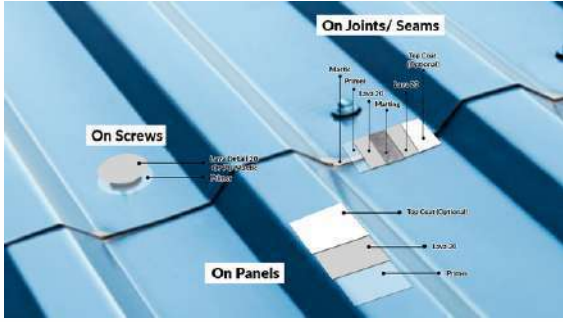

Metal

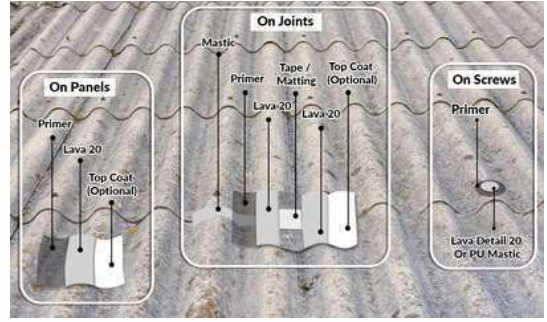

Asbestos

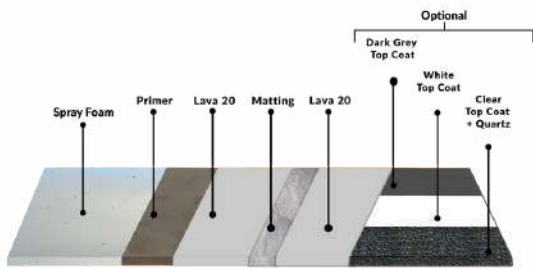

Spray Foam

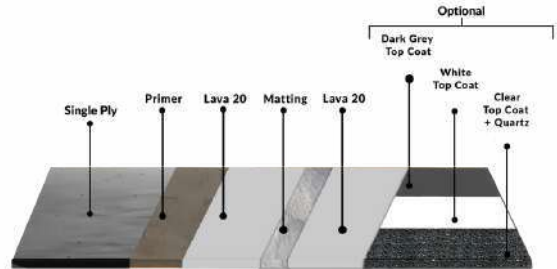

Single Ply

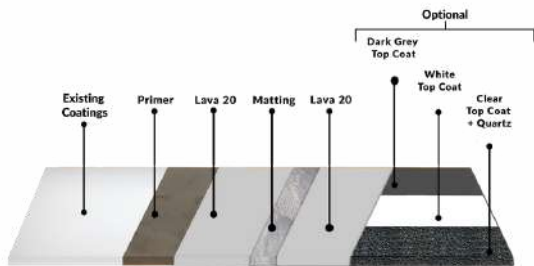

Existing Coatings

LAVA 20 SYSTEM DETAILED DRAWING

OWL LAVA - Detail Roof Edge

DETAIL OT-1

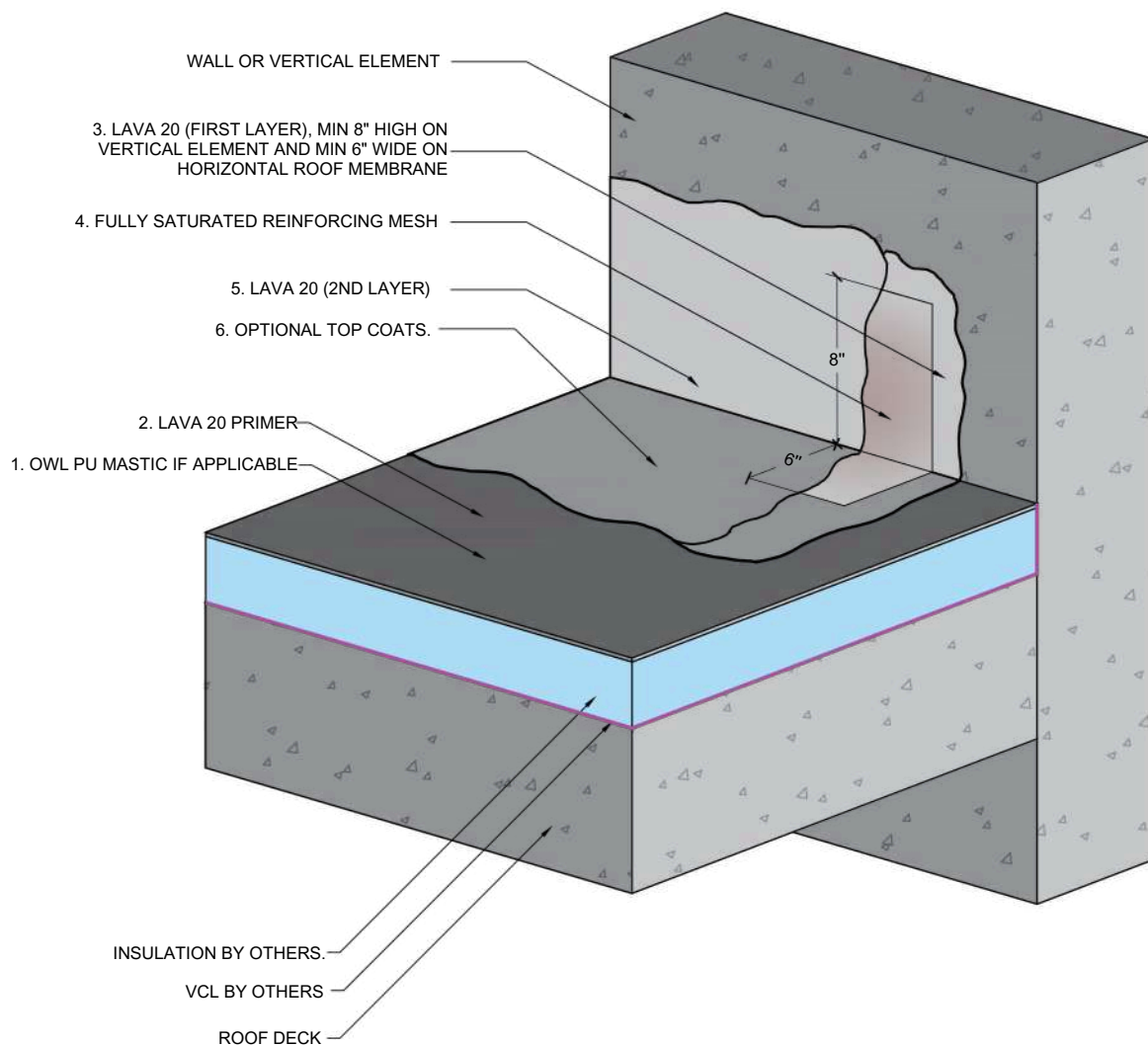

Notes:

1. Proper surface preparation of existing roof surface critical to installation.
2. These details are indicative only and for demonstration purposes only.

OWL LAVA - Detail Roof Edge - Two Pieces

DETAIL OT-1A

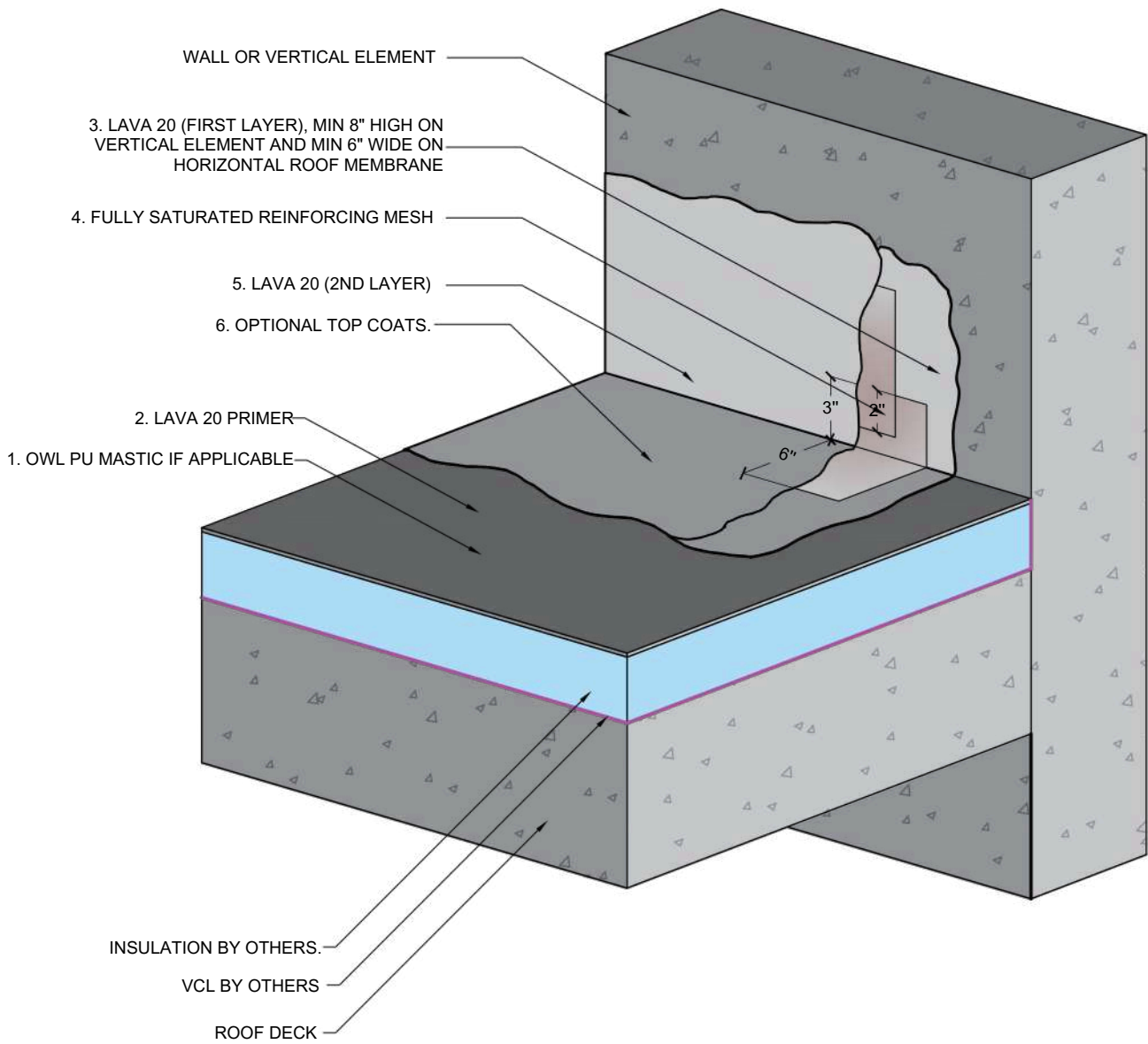

Notes:

1. Proper surface preparation of existing roof surface critical to installation.
2. These details are indicative only and for demonstration purposes only.

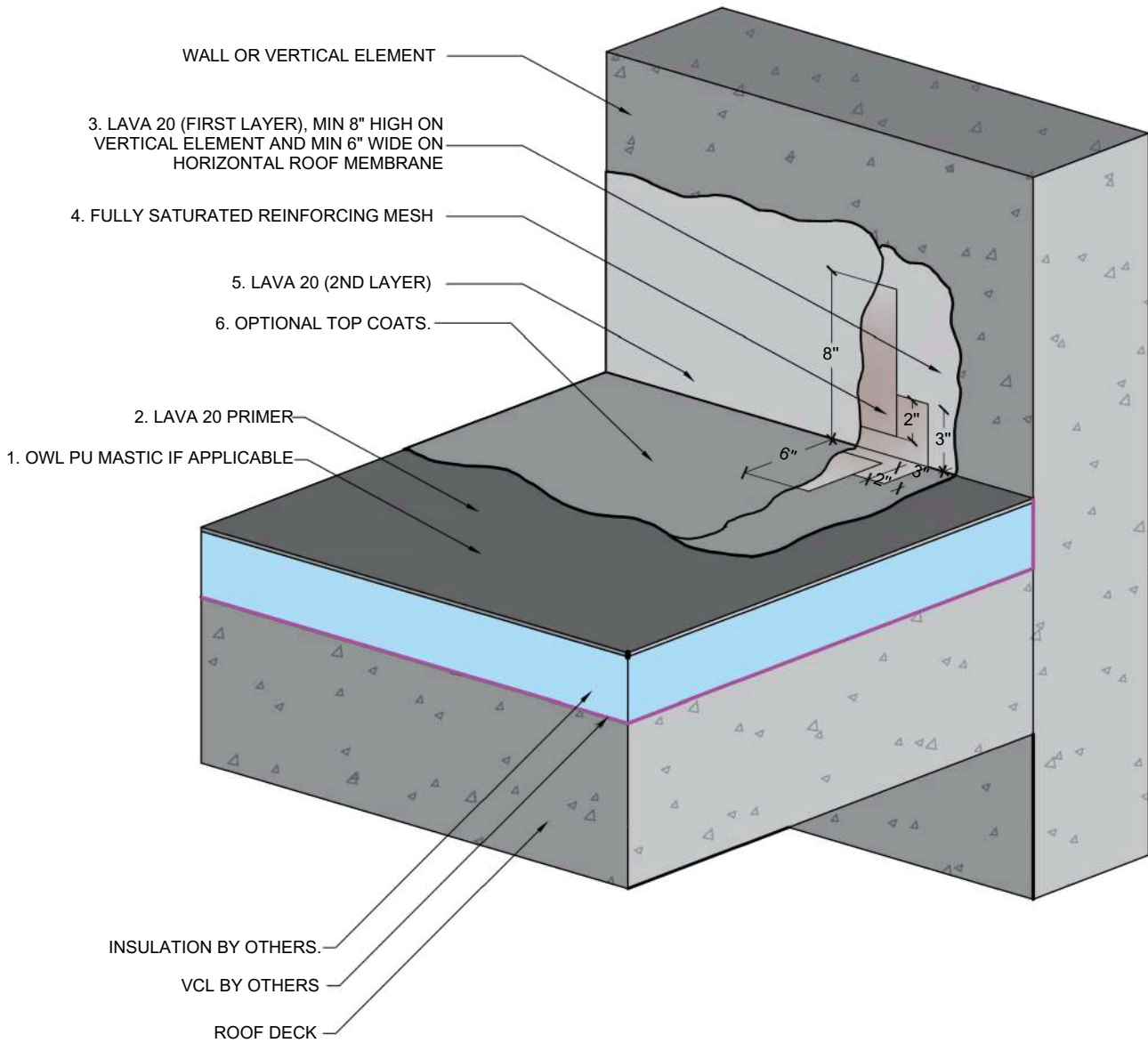

Notes:

1. Proper surface preparation of existing roof surface critical to installation.
2. These details are indicative only and for demonstration purposes only.

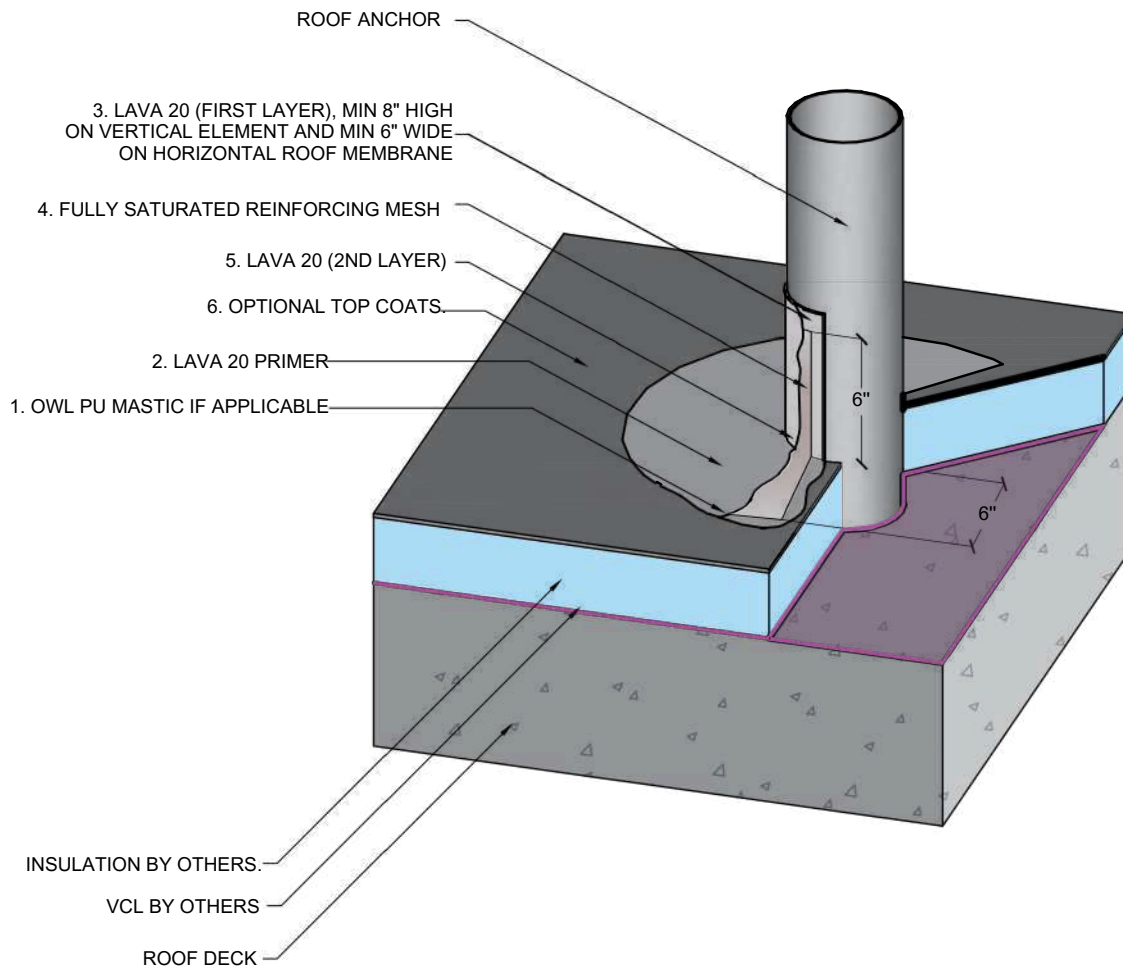

Notes:

1. Proper surface preparation of existing roof surface critical to installation.
2. These details are indicative only and for demonstration purposes only.

OWL LAVA - Detail Metal Drip Edge

DETAIL OT-3

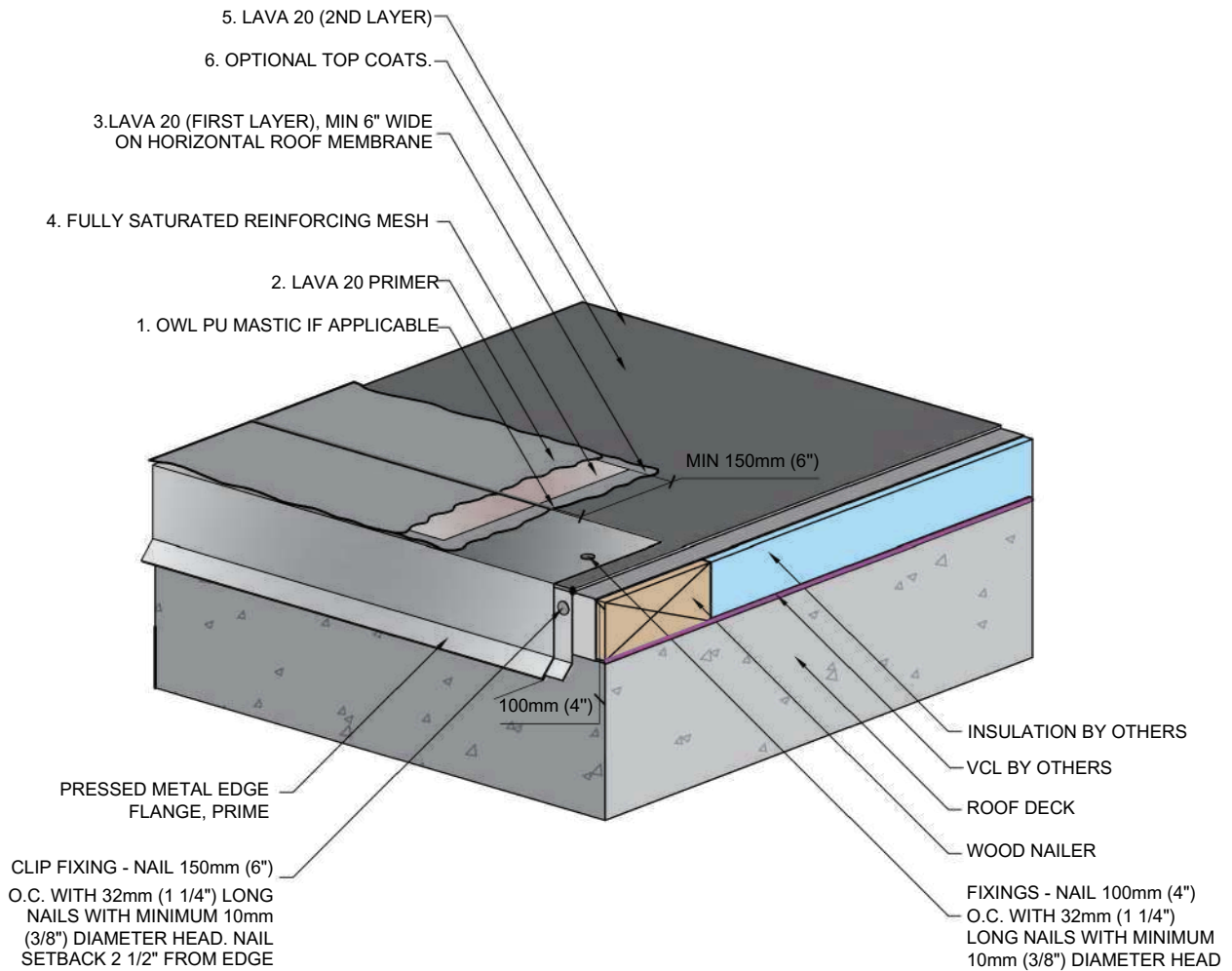

Notes:

1. Proper surface preparation of existing roof surface critical to installation.
2. These details are indicative only and for demonstration purposes only.

OWL LAVA - Detail Drain

DETAIL OT-4

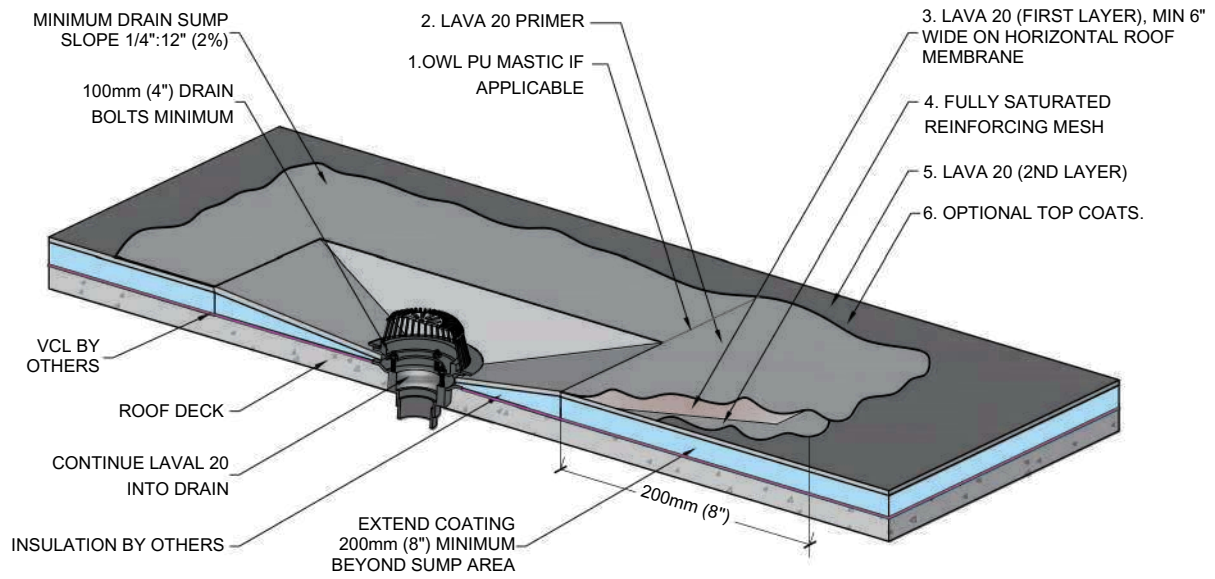

ISOMETRIC SECTION

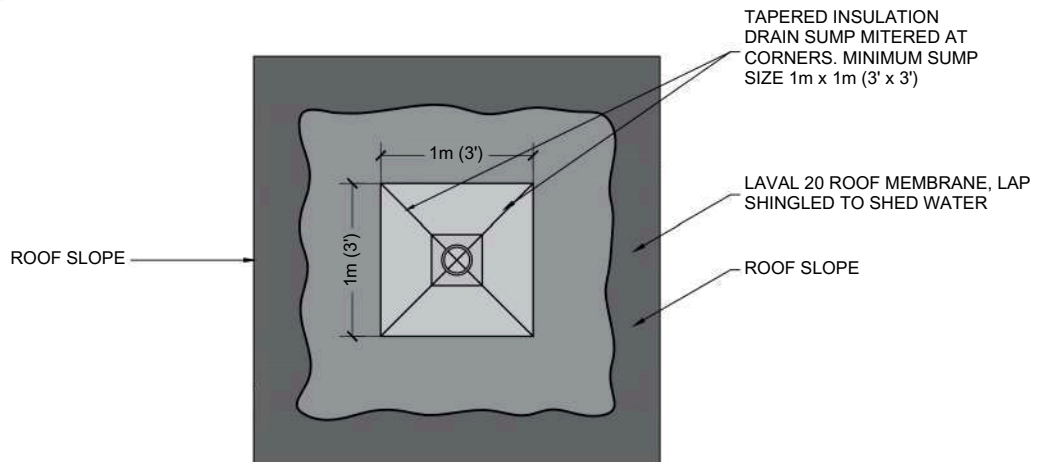

PLAN

Notes:

1. Proper surface preparation of existing roof surface critical to installation.
2. These details are indicative only and for demonstration purposes only.

OWL LAVA - Detail Drain - Spliced Corners

DETAIL OT-4A

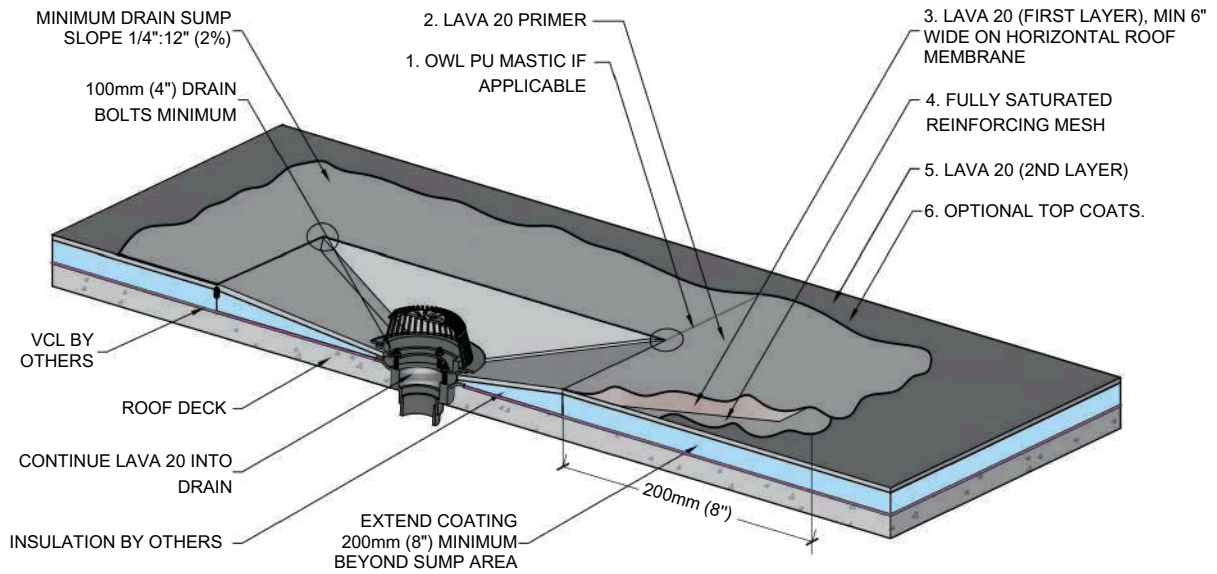

ISOMETRIC SECTION

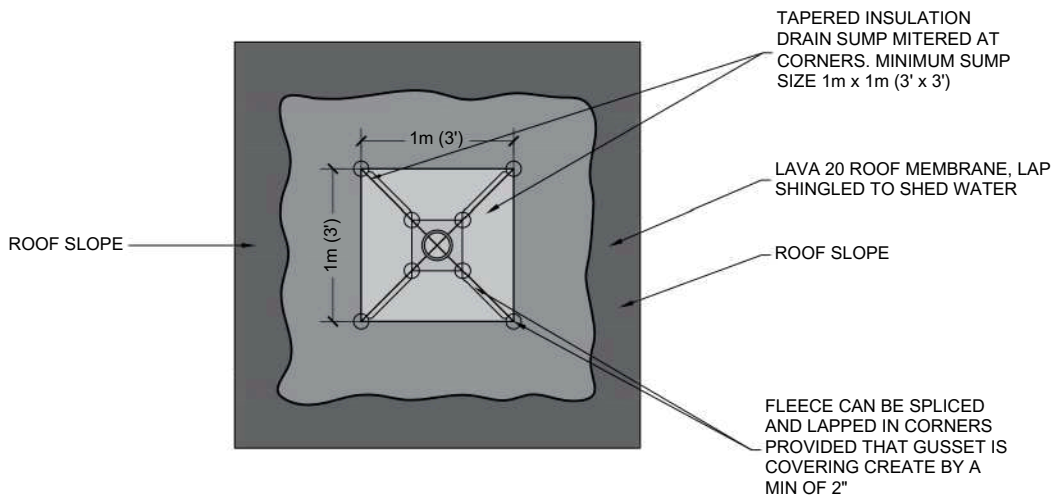

PLAN

Notes:

1. Proper surface preparation of existing roof surface critical to installation.
2. These details are indicative only and for demonstration purposes only.

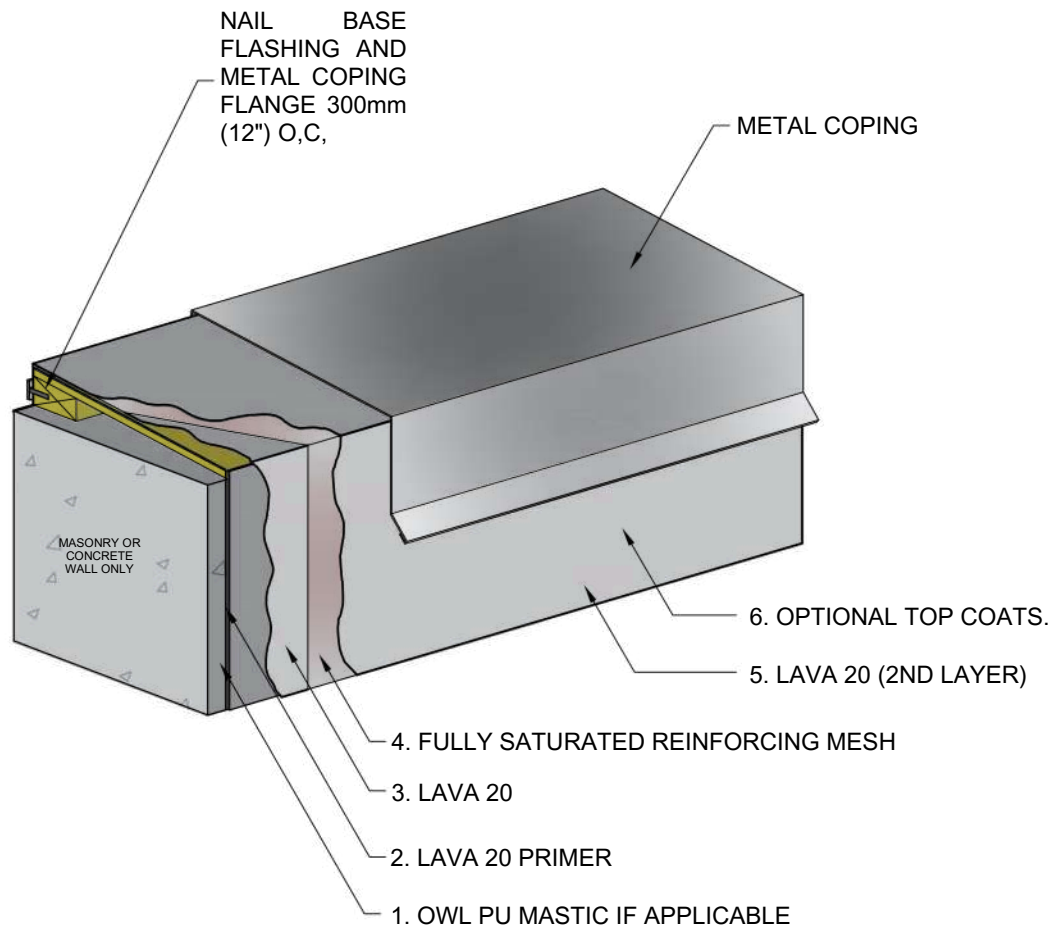

Notes:

1. Proper surface preparation of existing roof surface critical to installation.
2. These details are indicative only and for demonstration purposes only.

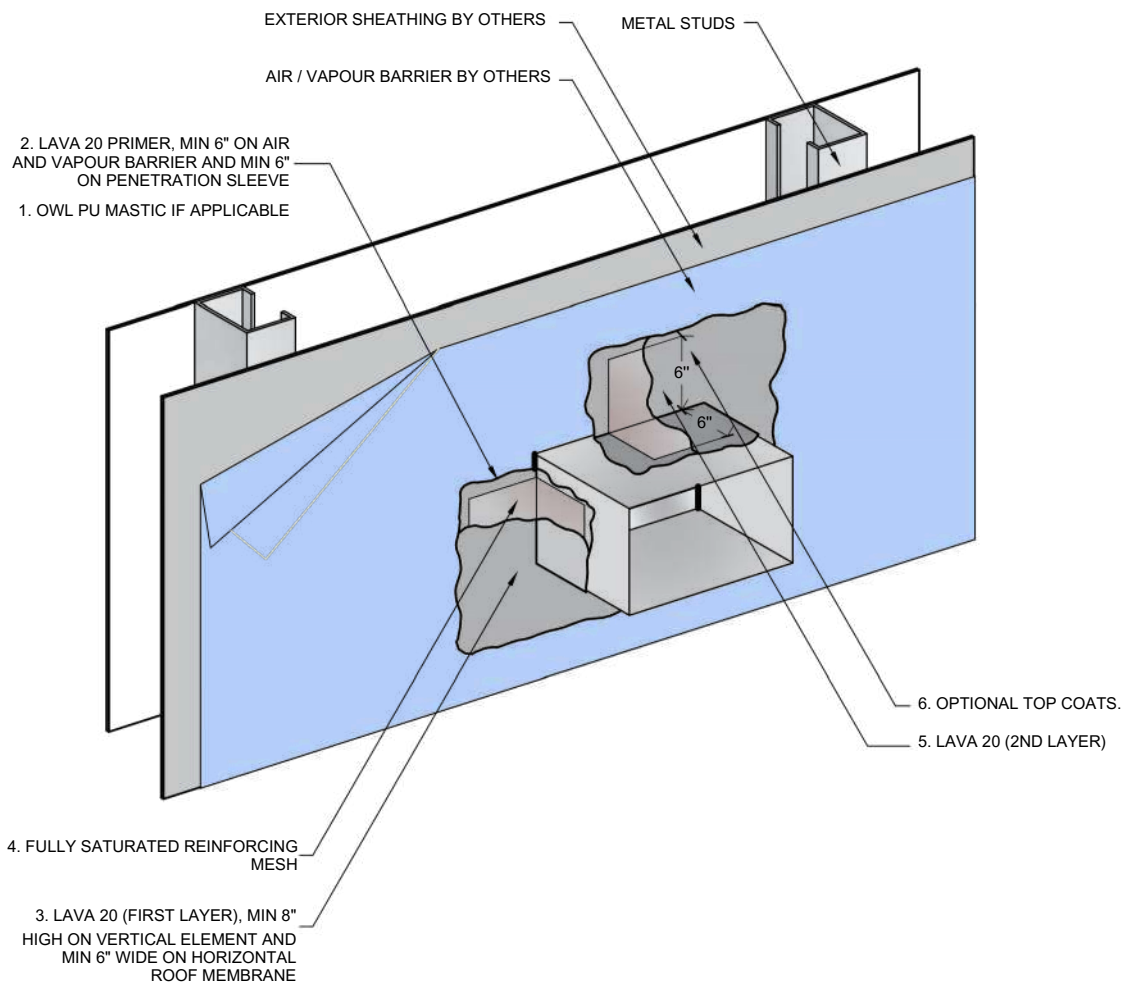

Notes:

1. Proper surface preparation of existing roof surface critical to installation.
2. These details are indicative only and for demonstration purposes only.

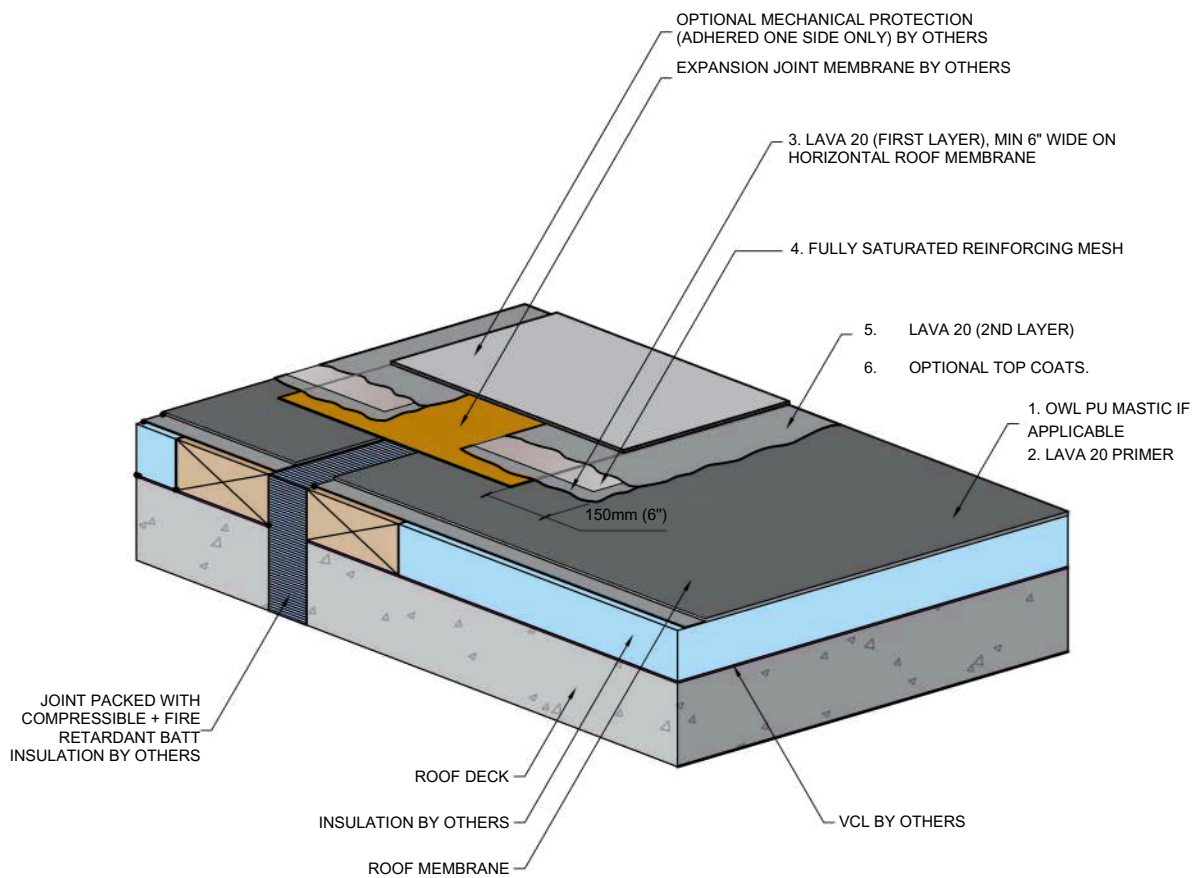

Notes:

1. Proper surface preparation of existing roof surface critical to installation.
2. These details are indicative only and for demonstration purposes only.

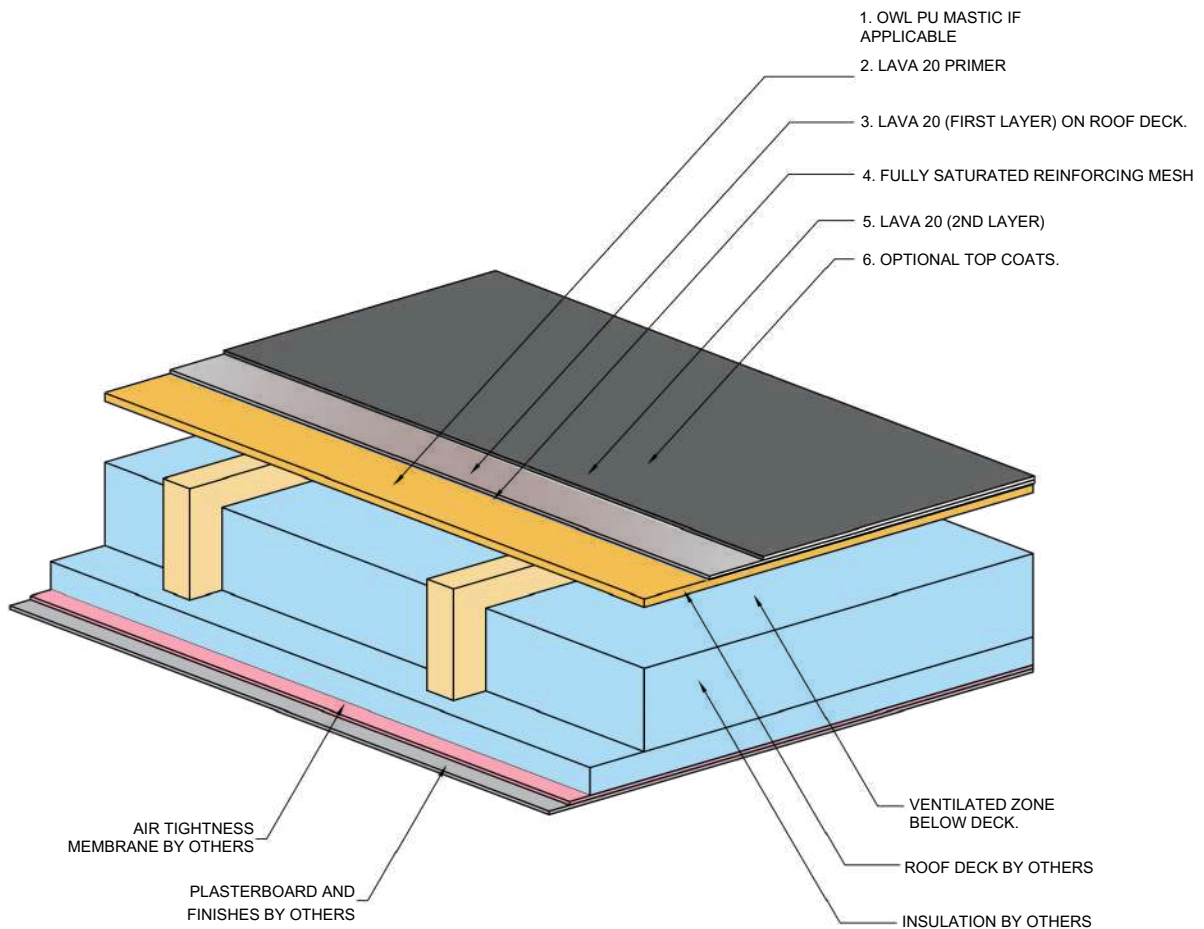

Notes:

1. Proper surface preparation of existing roof surface critical to installation.
2. These details are indicative only and for demonstration purposes only.

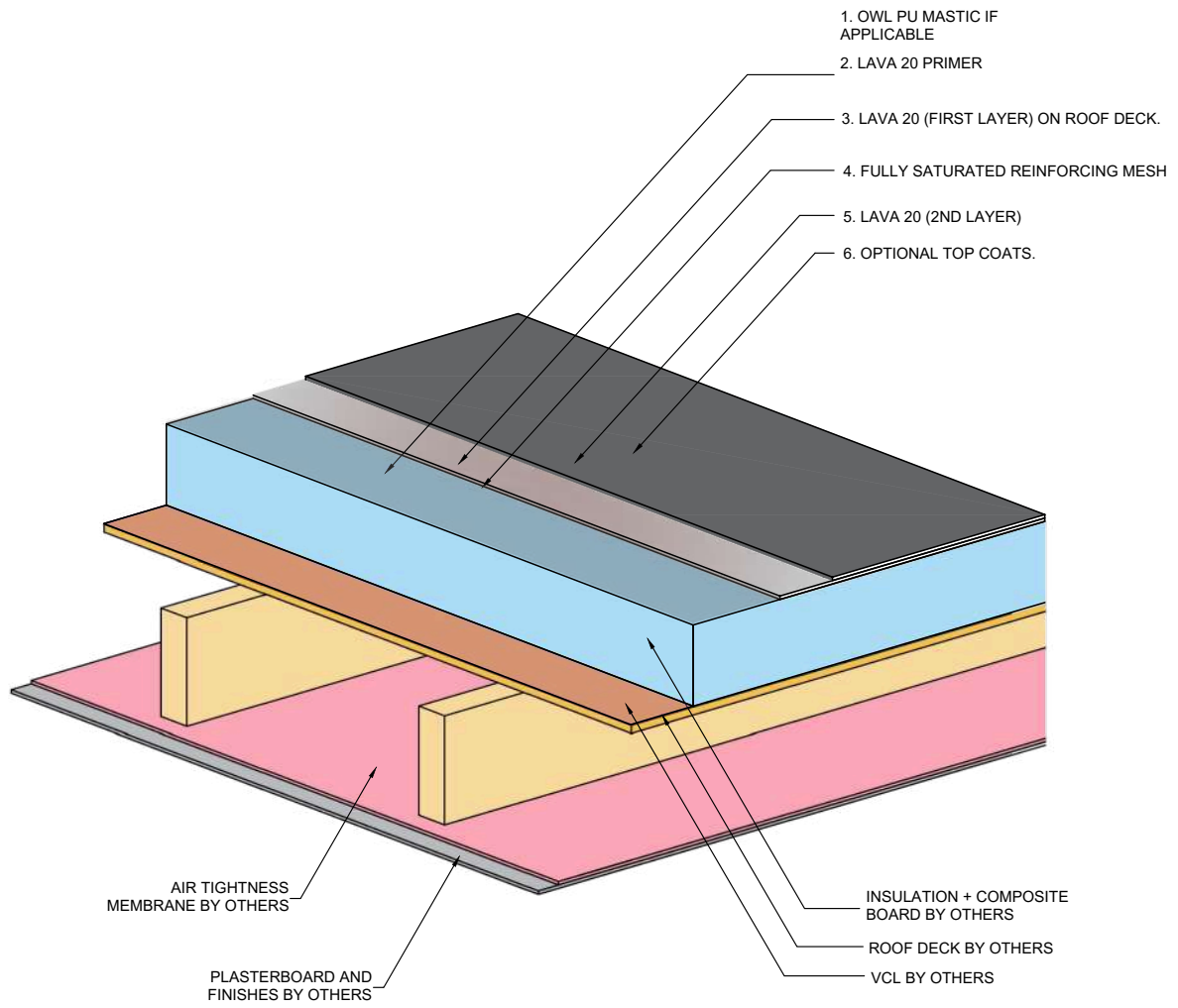

Notes:

1. Proper surface preparation of existing roof surface critical to installation.
2. These details are indicative only and for demonstration purposes only.

DIFFERENT PROJECTS WITH LAVA 20



AFTER



BEFORE



TIMBER (OSB / WPB PLYWOOD)



AFTER



BEFORE



CONCRETE



AFTER

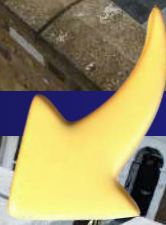

BEFORE



TORCH DOWN FELT / BUR



AFTER



BEFORE



ASPHALT



AFTER



BEFORE



METAL



AFTER



BEFORE



**INSULATION BOARDS & CEMENT
BOARDS**



AFTER



BEFORE



SPRAY FOAM



AFTER

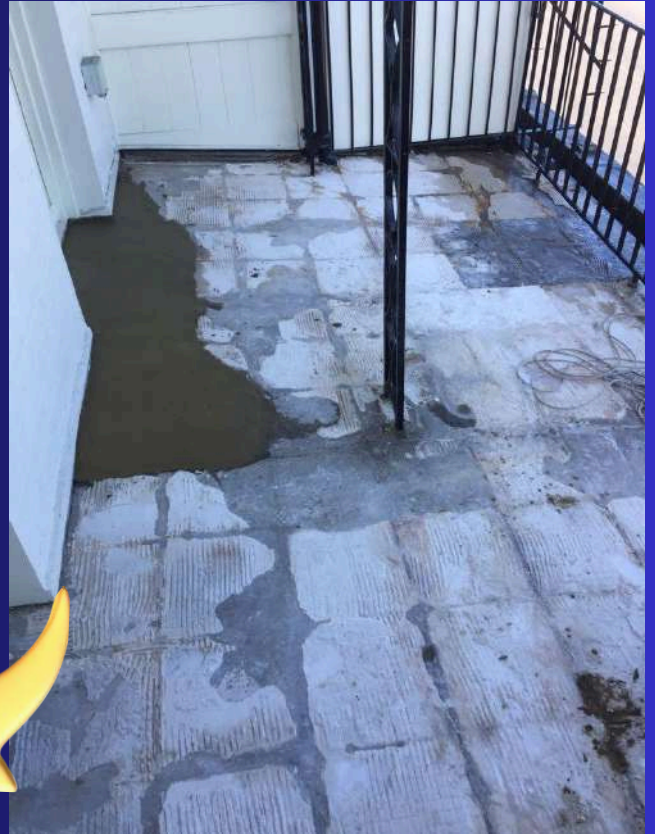

BEFORE



BALCONIES



AFTER

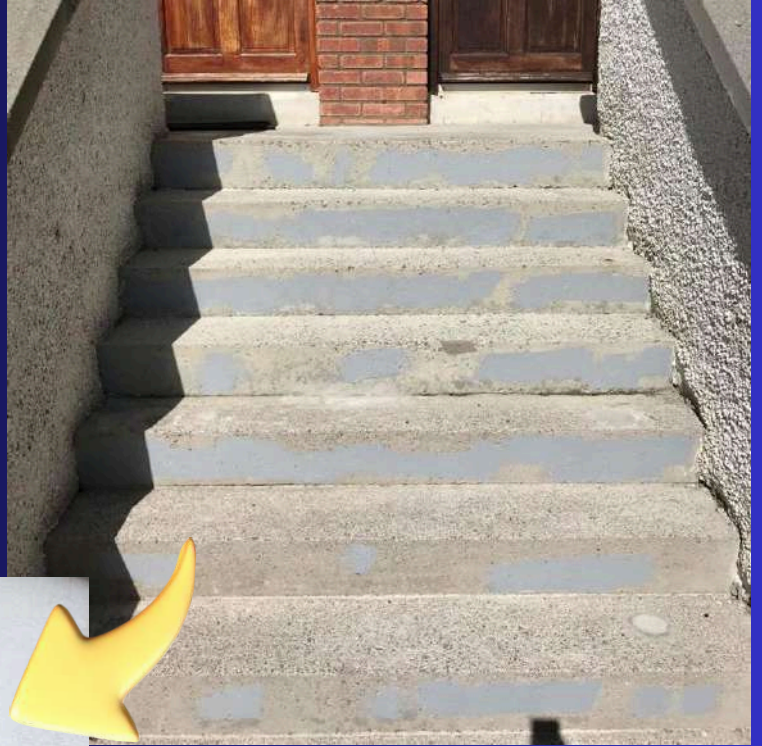

BEFORE

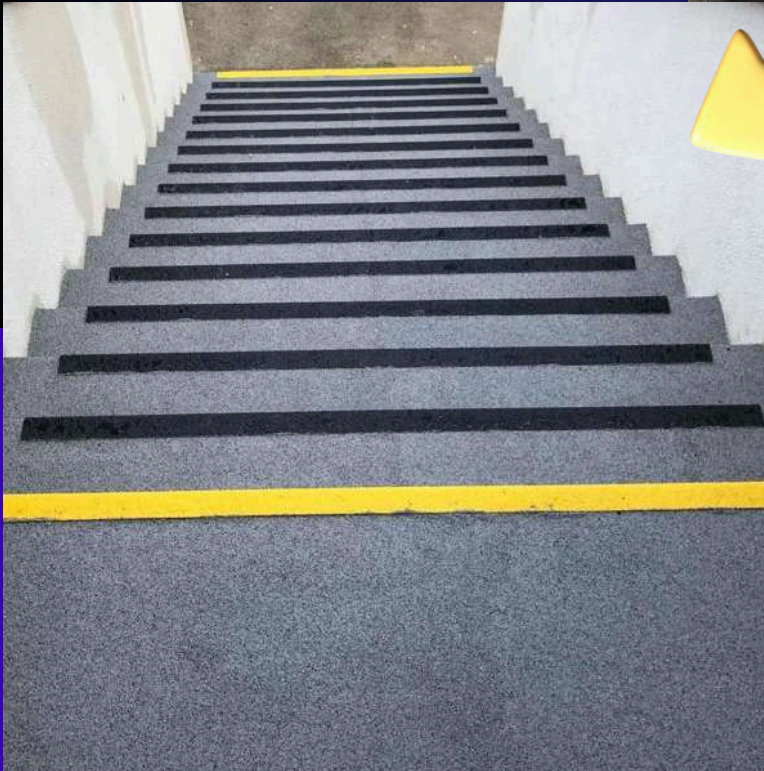

STAIRS



AFTER



BEFORE



GUTTERS

LAVA 20 (STANDARD SOLVENT SYSTEM) QUICK STEP BY STEP GUIDE

STEP 1

Ensure the surface is clean and dry.

STEP 2

Fill any joints, holes or voids with Owl PU Mastic.

STEP 3

Prime the entire area with Lava 20 Fast Primer / EPDM Primer / PVC Primer/ UV Primer / Epoxy primer.

STEP 4

Apply the Lava 20 liquid rubber system with reinforcement tape/matting as required and then apply another coat of Lava 20 if using matting / tape.

STEP 5

(Optional / recommended) apply any colour top coat for a hard / scratch resistant finish with an even longer life or use Lava 20 Clear Top Coat and quartz for an anti slip finish.



Application Specification:

(Plywood/Concrete)
June 2022

LAVA 20 POLYURETHANE ELASTOMERIC COATING SYSTEM FOR ROLLER APPLICATION ON PLYWOOD AND CONCRETE DECKS

PART 1 - GENERAL

1.1 SUMMARY

This section describes the requirements for installing a liquid applied waterproofing, wear surface for deck surfaces over occupied space. Its intended use is suitable for residential and commercial foot traffic, patio furniture and similar equipment.

1.2 RELATED SECTIONS

- A. Cast-In-Place Concrete: Division 03 30 00
- B. Flashing and Sheet Metal: Division 07 60 00
- C. Drains, Vents, and Penetrations: Division 22 14 26.13

1.3 SUBMITTALS

- A. Product Data: Submit manufacturer's standard submittal package including specification, installation instructions, and general information for each waterproofing material.
- B. Americans with Disabilities Act (ADA) Recommendations: Prior to installation, submit manufacturer's data indicating that the specified waterproofing application conforms to the provisions of the ADA Accessibility Guidelines as published by the US Access Board, 1331 F Street, NW, Suite 1000, Washington, DC 20004-1111.
- C. The static coefficient shall exceed the minimum recommendations of the American Disability Act (ADA), for accessible routes, for wet and dry surfaces, and for leather and rubber heel materials.

1.5 DELIVERY, STORAGE AND HANDLING

- A. Store all coating materials in the original unopened containers at 50 to 80 °F (10 to 27 °C) till coating is ready for use.
- B. Follow the special handling or storage requirements of the manufacturer for cold weather, hot weather, etc.
- C. Safety: Refer to all applicable data, including, but not limited to MSDS, PDS, product labels, specific instructions for specific personal protection requirements.
- D. Environmental requirements: Proceed with work of this section only when existing and forecasted weather conditions will permit the application to be performed in accordance with the manufacturer's recommendations.

1.6 JOB CONDITIONS

- A. Safety: Refer to all applicable data, including, but not limited to SDS, PDS, product labels and specific instructions for specific personal protection requirements.
- B. Weather: Proceed with the work of this section only when existing and forecasted weather conditions will permit the application to be performed in accordance with the manufacturer's recommendations.

1.7 WARRANTY

A 25-year warranty is available for commercial & domestic projects.

PART 2 - PRODUCTS

2.1 MANUFACTURERS

Acceptable Manufacturers:

OWL WATERPROOFING SOLUTIONS - www.owlwaterproofing.co.uk

2.2 MATERIALS

- A. Primer: Lava Prime
- B. Polyurethane Base Coating: Lava 20
- C. Polyurethane Top Coating: Lava Top Coat
- D. Flashing and Joint Reinforcing Fabric: Polyester Tape or chop strand matting as required for flashing drains, base angles, etc.
- E. Misc. Accessories: All items incorporated into this system shall be compatible with and approved by the coating manufacturer.
NOTE: Allow additional material for rough or irregular surfaces. Consult OWL Technical Service for further inquiries.

3.1 EXAMINATION

- A. Verify substrate is ready to receive work; surface is clean, dry and free of substances that could affect the bond.
- B. Verify that the plywood / OSB shall conform to U.S. DOC PS 1 or CSA 0325 and shall carry the grade trademark of the Engineered Wood Association - APA AB EXT or APA AC EXT are acceptable. Underlayment grade plywood (APA AC EXT Underlayment) with solid, plugged cross bands under the face veneer is recommended for commercial installations.
- C. **Unacceptable Grades:** APA C-D EXT, APA C-C EXT, Exposure 1 markings, oriented strand board (OSB), waferboard and Lauan or Mahogany plywood are **NOT** suitable substrates for liquid-applied coating systems. This is due to poor dimensional stability, weak glue lines which allow buckling or lifting of the top ply, and excessive splintered, leafed and raised surface grain.
- D. Do not begin the work until the concrete substrate has cured 28 days and/or has achieved a moisture content of no greater than 12%.
- E. Ensure the substrate condition is clean and dry and ready to receive the waterproofing application.

3.2 PREPARATION

- A. Clean substrate to remove all surface contaminants.
- B. Mask off all adjoining areas that are not to receive the fluid applied waterproofing.
- C. Provide a suitable workstation to mix the coating materials.

3.3 INSTALLATION

A. Concrete

New concrete shall have cured a minimum of 28 days. New or existing concrete shall be free of oil, grease, curing compounds, loose particles, moss, algae growth, laitance, friable matter, dirt, bituminous products, and previous waterproofing materials. New or existing concrete shall be dry.

Application Process

Step 1. Fill and smooth any crack or voids with the Owl PU Mastic

Step 2. Prime the whole area with Lava Prime at a rate of one gallon per 203 sq ft & allow the dry for 2 -3 hours

Step 3. Simply coat the whole area with Lava 20 at a rate of 0.061 gallon PER sq ft

Step 4. (Optional) Apply the Lava Topcoat over the entire area coverage 1 gallon per 215 sq ft. If using any colour Top Coat and Quartz or Aggregate for an Anti Slip Finish the consumption rate is typically halved due to the textured granular surface; approximately 1 gallon per 100 sq ft² depending on the size of the aggregate / quartz.

B. Wood / Plywood

New or existing wood / plywood shall be dry with a maximum moisture content of (5%) five percent. Coating over wet components will adversely affect the adhesion of the Lava 20 coatings.

Application Process

Step 1. Fill and smooth any crack or voids with the Owl PU Mastic

Step 2. Prime the whole area with Lava Prime at a rate of one gallon per 203 sq ft & allow the dry for 2 -3 hours

Step 3. Reinforce all joints using the polyester fabric tape. Apply Lava 20 over the joint then cut your tape to size place the tape over the joint, then apply more Lava 20 to embed the tape.

Step 4. Simply coat the whole area with Lava 20 at a rate of 0.061 gallon per sq ft

Step 5. (Optional) Apply the Lava Topcoat over the entire area coverage 1 gallon per 215 sq ft. If using any colour Top Coat and Quartz or Aggregate for an Anti Slip Finish the consumption rate is typically halved due to the textured granular surface; approximately 1 gallon per 100 sq ft² depending on the size of the aggregate / quartz.



Application Specification:

(Asphalt / Torched Down Felt / BUR)
(Metal/Steel)
June 2022

LAVA 20 POLYURETHANE ELASTOMERIC COATING SYSTEM FOR ROLLER APPLICATION ON Asphalt / Torched Down Felt / BUR Metal / Steel

PART 1 - GENERAL

1.1 SUMMARY

This section describes the requirements for installing a liquid applied waterproofing, wear surface for deck surfaces over occupied space. Its intended use is suitable for residential and commercial foot traffic, patio furniture and similar equipment.

1.2 RELATED SECTIONS

- A. Cast-In-Place Concrete: Division 03 30 00
- B. Flashing and Sheet Metal: Division 07 60 00
- C. Drains, Vents, and Penetrations: Division 22 14 26.13

1.3 SUBMITTALS

- A. Product Data: Submit manufacturer's standard submittal package including specification, installation instructions, and general information for each waterproofing material.
- B. Americans with Disabilities Act (ADA) Recommendations: Prior to installation, submit manufacturer's data indicating that the specified waterproofing application conforms to the provisions of the ADA Accessibility Guidelines as published by the US Access Board, 1331 F Street, NW, Suite 1000, Washington, DC 20004-1111.
- C. The static coefficient shall exceed the minimum recommendations of the American Disability Act (ADA), for accessible routes, for wet and dry surfaces, and for leather and rubber heel materials.

1.5 DELIVERY, STORAGE AND HANDLING

- A. Store all coating materials in the original unopened containers at 50 to 80 °F (10 to 27 °C) till coating is ready for use.
- B. Follow the special handling or storage requirements of the manufacturer for cold weather, hot weather, etc.
- C. Safety: Refer to all applicable data, including, but not limited to MSDS, PDS, product labels, specific instructions for specific personal protection requirements.

- D. Environmental requirements: Proceed with work of this section only when existing and forecasted weather conditions will permit the application to be performed in accordance with the manufacturer's recommendations.

1.6 JOB CONDITIONS

- A. Safety: Refer to all applicable data, including, but not limited to SDS, PDS, product labels and specific instructions for specific personal protection requirements.
- B. Weather: Proceed with the work of this section only when existing and forecasted weather conditions will permit the application to be performed in accordance with the manufacturer's recommendations.

1.7 WARRANTY

A 25-year warranty is available for commercial & domestic projects.

PART 2 - PRODUCTS

2.1 MANUFACTURERS

Acceptable Manufacturers:

OWL WATERPROOFING SOLUTIONS - www.owlwaterproofing.co.uk

2.2 MATERIALS

- A. Primer: Lava Super Quick Prime
- B. Polyurethane Base Coating: Lava 20
- C. Polyurethane Top Coating: Lava Top Coat (any colour or clear)
- D. Flashing and Joint Reinforcing Fabric: Polyester Tape or chop strand matting as required for flashing drains, base angles, etc.
- E. Misc. Accessories: All items incorporated into this system shall be compatible with and approved by the coating manufacturer.

NOTE: Allow additional material for rough or irregular surfaces. Consult OWL Technical Service for further inquiries.

3.1 EXAMINATION

- A. Asphalt needs to be clean from any loose particles, moss, algae growth, etc. Surface needs to be fully dry before the application. Do not apply Owl Waterproofing products over asphalt or asphalt products that have not aged for a minimum of 180 days. Coating over uncured (not aged) asphalt products will cause staining and/or blistering of the Lava 20 . Full reinforcement will be required using the Glass fiber (Chop Stand Matting) or Polyester Fabric
- B. Surface needs to be clean and dry any rust needs to be treated.

3.2 PREPARATION

- A. Clean substrate to remove all surface contaminants.
- B. Mask off all adjoining areas that are not to receive the fluid applied waterproofing.
- C. Provide a suitable workstation to mix the coating materials.

3.3 INSTALLATION

A. Existing Bitumen Based Materials (Asphalt / Torched Down Felt / BUR)

Asphalt needs to be clean from any loose particles, moss, algae growth, etc.

Surface needs to be fully dry before the application. Do not apply Owl Waterproofing products over asphalt or asphalt products that have not aged for a minimum of 180 days. Coating over uncured (not aged) asphalt products will cause staining and/or blistering of the Lava 20 . Full reinforcement will be required using the Glass fiber (Chop Stand Matting)

Application.

Step 1. Fill and smooth any crack or voids with the Owl PU Mastic

Step 2. Prime the whole area with Lava Prime at a rate of one gallon per 203 sq ft² & allow the dry for 2 -3 hours

Step 3. Apply Lava 20 over a section of the area then reinforce the area by embedding the Chop Strand Matting or Polyester Fabric into the wet coating, then apply more Lava 20 to complete the waterproofing system. Coverage 0.061 gallon per sq ft²

Step 4. (Optional) Apply the Lava 20 Top Coat over the entire area coverage 1 gallon per 215 sq ft². If using any colour Top Coat and Quartz or Aggregate for an Anti Slip Finish the consumption rate is typically halved due to the textured granular surface; approximately 1 gallon per 100 sq ft² depending on the size of the aggregate / quartz.

B. Metal/Steel

Surface needs to be clean and dry; any rust needs to be treated before Lava Prime

Application.

Step 1. Fill and smooth any crack or voids with the Owl PU Mastic

Step 2. Prime the whole area with Lava Prime at a rate of one gallon per 203 sq ft² & allow the dry for 2 -3 hours

Step 3. Reinforce all joints using the polyester fabric tape. Apply Lava 20 over the joint then cut your tape to size place the tape over the joint, then apply more Lava 20 to embed the tape.

Step 4. Simply coat the whole area with Lava 20 at a rate of 0.061 gallon per sq ft²

Step 5. (Optional) Apply the Lava Topcoat over the entire area coverage 1 gallon per 215 sq ft². If using any colour Top Coat and Quartz or Aggregate for an Anti Slip Finish the consumption rate is typically halved due to the textured granular surface; approximately 1 gallon per 100 sq ft² depending on the size of the aggregate / quartz.



OWL WATERPROOFING

THE WISE CHOICE

APPLICATION GUIDE LAVA 20 SYSTEM



ROOF & BALCONY/ DECK WATERPROOFING

This application guide outlines the application process for the Lava 20 System



Lava 20 System

The Durable, Versatile & Flexible Liquid Rubber Waterproofing System For Flat or Low Pitched Roofs, Balconies, Decks & Terraces etc.

The Lava 20 System is ideal for enhancing the durability and resilience of various surfaces exposed to diverse environmental challenges. It proves effective for:

- Flat Roofs, Balconies, Terraces & Car Parks
 - Wet Areas
 - Sloped Roofs
 - Under or Over Tiles
 - Public Walkways etc.
-

Uses & Benefits

- Cost Effective
 - Flexible / High Elasticity
 - Ponding Water Resistant
 - Withstands All Temperatures (Freezing & Hot)
 - Chemical Resistant
 - Seamless / No Joints
 - Versatile
 - Bonds to Almost Everything
 - Vapour Permeable (Breathable)
 - Easy Detailing
 - Maintenance Free
 - Fast & Easy to Apply
 - UV Resistant
 - 25 Year Warranty
 - Highly Durable
 - Optional Anti - Slip Finish
 - BBA & CE Certified
 - Highly Fire Rated
 - Remains Flexible in All Temperatures
-

Substrates

Bonds to almost all surfaces.

- Timber (OSB / Plywood)
 - Asphalt*
 - Torch Down Felt (BUR)*
 - Concrete
 - Tiles
 - Insulation
 - Cement Boards
 - Metals
 - Single Ply
 - Spray Foam
 - Asbestos
 - GRP
 - Existing Coatings (Except Silicone)
- *Requires Matting



Lava 20 System on Different Substrates

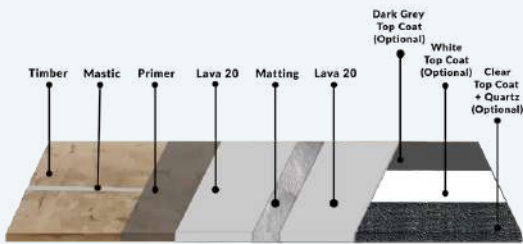

Timber

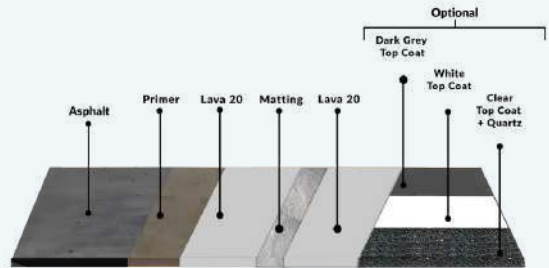

Asphalt

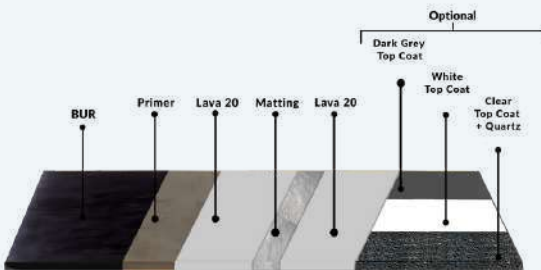

Torch Down Felt (BUR)

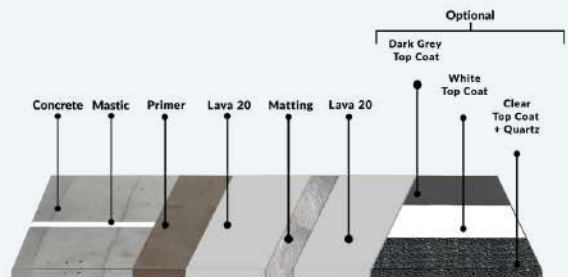

Concrete

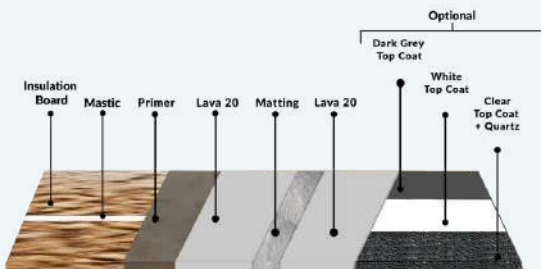

Insulation Board

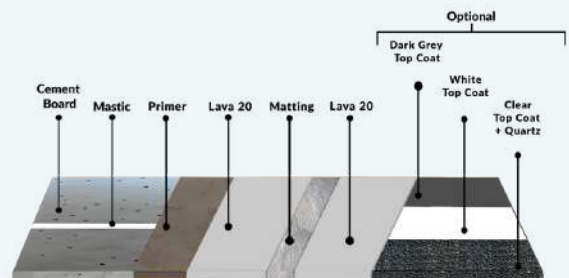

Cement Board



Lava 20 System on Different Substrates

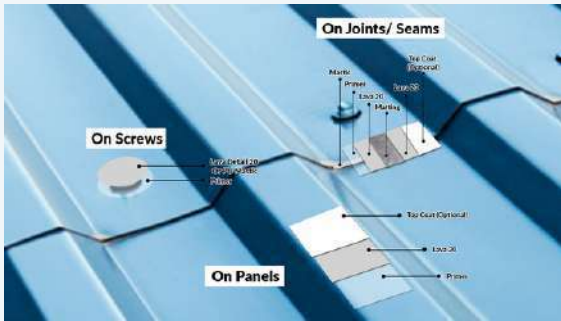

Metal

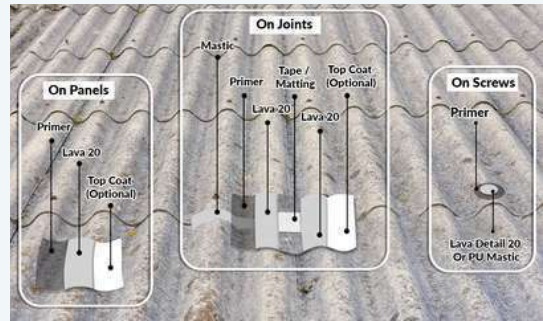

Asbestos

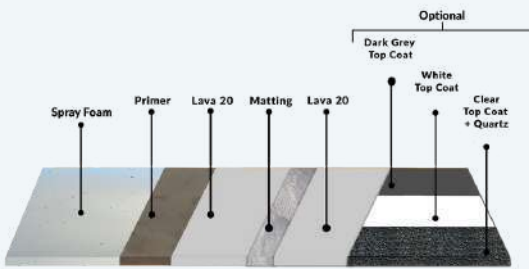

Spray Foam

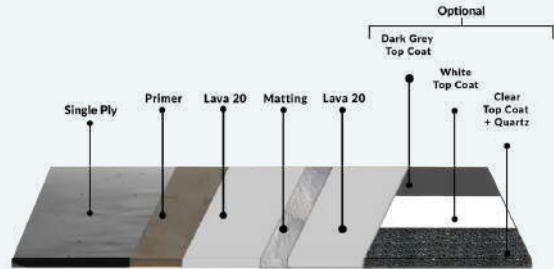

Single Ply

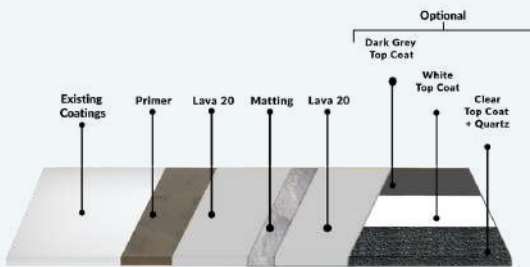

Existing Coatings



Installation Conditions:



Surface Treatment: Ensure the surface is clean and dry.

Weather Considerations: Application should only occur when there is no forecast of rain or snow.

Temperature Range: Ensure substrate temperatures are between 5°C and 35°C and at least 3°C above the dew point. If outside this range, consult with Owl Waterproofing Solutions.

Ventilation & PPE: Ensure adequate ventilation.
Ensure operative were correct PPE.

Fire and Spark Safety: Ensure there are no nearby open fires or sparks or anyone smoking.

Compliance with Regulations: Follow manufacturer's requirements and comply with local regulations governing workplace safety.

Tools & Equipment:



Personal Protective Equipment (PPE): Always wear PPE, protective gloves, protective eyewear, safety shoes, hardhats, and safety harnesses.

Application Tools: Solvent resistant rollers and brushes, mixing drill, paddle, masking tapes, scissors/ knives, mastic gun.



Environmental Requirements



Application Temperature:

Ideal temperatures are between 5°C and 35°C, with the surface being a minimum of 3°C above the dew point.

Cold Weather:

Application is possible in temperatures between 1°C and 5°C, but be aware of extended curing times.

Hot Weather:

Avoid applying in temperatures over 35°C due to the potential for blistering from vapors releasing from substrates and reduced working time and pot life. Store materials in the shade/ a cool location.

Humidity:

High humidity may affect the final finish & curing time.

Ideal humidity range for LAVA 20:

Lowest: 5%

Highest: 75%



General Preparation

Existing Surface Evaluation

- **Inspect the Site:** Assess site conditions and conduct adhesion tests.
- **Surface Repairs:** Owl Waterproofing Solutions recommends repairing any defects on the surface before applying LAVA 20.

Odor Precautions

Odor cautions are usually not required. However, follow these steps if needed.

- Seal air intakes with activated carbon filters.
- Seal windows, doors, and skylights.
- You can use moveable enclosures and/ or set up odor elimination stations equipped with air intake/ output, odor control air cleaners, and carbon filters at exhaust openings.



Products Description



Sealant:

Owl PU Mastic

Owl PU Mastic is an industrial strength polyurethane fast - curing adhesive & sealer.

- Fill & smooth holes, gaps, joints etc.
- Great adhesion to almost all surfaces.
- Suitable for almost any surface.
- Can be used alone for emergency repair.
- Can be used as a part of the Owl Lava 20 Waterproofing System.

Primers:

Lava 20 Fast Primer

Lava 20 Fast Primer is a single pack multi purpose primer for using with Lava 20 Waterproofing System. Perfect for concrete, wood and metals.

- Suitable for application on substrates with high, low or no porosity.
- Suitable for application on most existing coatings.

Owl Universal 2 Part Epoxy Primer

Owl Universal 2 Part Epoxy Primer is suitable for both absorbent and non-absorbent surfaces like torch down felt/ BUR, concrete, metals, timber, bitumen, asphalt, ceramic tiles, stone, and most existing coatings.

Lava 20 TPO/ EPDM Primer

Lava 20 TPO/ EPDM Primer is a single component, solvent based adhesion enhancer. Formulated to prepare TPO & EPDM membranes for excellent adhesion with the Lava 20 System.

Lava 20 Cleaner & PVC Primer

Lava 20 Cleaner & PVC Primer is a solvent based cleaner for the Lava 20 System & A washable PVC Primer. It's also used for airless spraying by machine to dilute Lava 20 by max 10% in weight and also this product can be used to clean tools etc.

Lava 20 UV Primer

Lava 20 UV Primer is a non yellowing primer, for using with Lava 20 or Lava 20 Clear Top Coat.



Products Description



Catalysts:

Lava 20 Catalyst

Lava 20 Catalyst is an accelerating additive, used with the liquid rubber waterproofing membrane Lava 20. It is used for a faster drying time and a thicker coat applications.

Available Size:

- Lava 20 6 KG + Lava 20 Catalyst **0.18 KG**
- Lava 20 15 KG + Lava 20 Catalyst **0.45 KG**
- Lava 20 25 KG + Lava 20 Catalyst **0.75 KG**

Liquid Waterproofing Membrane

Lava 20

Lava 20- the durable, versatile & flexible liquid rubber waterproofing system for flat or low pitched roofs, balconies, decks, terraces etc.

- 25 Year Warranty
- Chemical Resistant
- UV resistant
- Breathable
- Fast & easy application

Lava Detail 20 Fiber Reinforced

(Thicker Version of Lava 20)

Lava Detail 20 Reinforced is a fiber reinforced polyurethane coating for complex roofing details, such as: wall floor connections, flashings, corners, chimneys, pipes, gutter, outlets, screws, fixings.

- Liquid Applied; Thixotropic
- Permanently flexible
- Easy & fast to use
- Great for awkward details.

Lava 20 Vertical

(Thicker Version of Lava 20)

Lava 20 Vertical is a semi thixotropic viscosity suitable for vertical, sloped & also flat surfaces.

- Provides waterproofing
- Provides water vapour permeability
- Weather & UV resistant
- Provides high sun reflectivity, contributes to thermo insulation



Products Description



Reinforcement Fabrics - For Extra Strength and Durability

Chopped Strand Matting

Emulsion binder fiberglass matting for strength and reinforcement. Good for flat surfaces, does not break down.

Powder binding fiberglass matting for strength and reinforcement. (Breaks down). Good for detail (i.e. rounded corners) and flat surfaces.

Polyester Reinforcing Fabric

Polyester reinforcement. Suitable for any surface.

Top Coats - Any Top Coat Can be Used Alone or with Quartz/ Sand for an Anti Slip Finish

Lava 20 Clear Top Coat

Lava 20 Clear Top coat is a durable, transparent polyurethane waterproofing coating designed to be tough and long-lasting. Its advanced formulation remains transparent and flexible, even after aging, and offers UV stability without yellowing, resistance to weather, alkalis, and chemicals. Lava 20 Clear Top coat serves as a transparent binder resin anti slip for stone carpet finishes, particularly in exterior applications where durability, UV stability and flexibility are essential. This top coat is moisture cured and fast drying. Long lasting and durable performance.

Lava 20 Coloured Top Coats

Lava 20 Coloured Top Coat is a pigmented, colour- and UV-stable, highly elastic polyurethane coating designed as a top-coat for protecting exposed polyurethane waterproofing membranes.

Available Colours: Dark Grey (RAL 7016), White (RAL 9003), Red (RAL 3011), Blue (RAL 5015), Green (RAL 6002), Light Grey (RAL 7005), Yellow (RAL 1018), Black (RAL 9017), Brown (RAL 8028) (Special colours on request).

Long lasting and durable performance.

Zero degradation. In theory lasts forever.



Technical Installation Guide

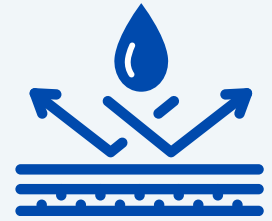

The Liquid Applied Roof Waterproofing Kit 'LAVA 20 SYSTEM' is designed and installed in accordance with the manufacturer design and installation instructions.
(ETA 22/0640)

Lava 20 Primer over concrete metal and PU: Epoxy Water Based			
Warranty	25 Year	25 Year	10 Year (Metal Only)
	System 1 (Lava 20 + Top Coat)	System 2 (Lava 20 Only: 2.9 mm)	System 3 (Lava 20 Only: 1.6 mm)
Consumption	≥ 0.15 kg/m ²	≥ 0.15 kg/m ²	≥ 0.15 kg/m ²

Lava 20 Waterproofing Membrane			
Warranty	25 Year	25 Year	10 Year (Metal Only)
	System 1 (Lava 20 + Top Coat)	System 2 (Lava 20 Only: 2.9 mm)	System 3 (Lava 20 Only: 1.6 mm)
	Lava 20 + 3% (weight) Lava 20 Catalyst + Optional: Lava 20 Top Coat	Lava 20 + 3% (weight) Lava 20 Catalyst	
Consumption	≥ 2.3 kg/m ²	≥ 1.8 kg/m ²	≥ 1.8 kg/m ²
Internal Mesh	Lava 20 Polyester / Chopped Strand Matting Reinforcing Fabric	-	

Lava 20 Top Coat Finish Layer: UV Protection			
Warranty	25 Year	25 Year	10 Year (Metal Only)
	System 1 (Lava 20 + Top Coat)	System 2 (Lava 20 Only: 2.9 mm)	System 3 (Lava 20 Only: 1.6 mm)
	Optional: Lava 20 Top Coat	Optional Lava 20 Top Coat	
Consumption		≥ 0.15 kg/m ²	
Thickness	1.2 mm	1.0 mm	



Technical Installation Guide

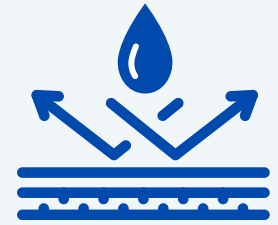

Warranty	25 Year	25 Year
Characteristics	System 1 (Lava 20 + Top Coat)	System 2 (Lava 20 Only: 2.9 mm)
Thickness	1.2 mm	1.0 mm
External Fire Performance	B _{ROOF} (t4)	NPA
Reaction to Fire	NPA	NPA
Categorization by Working life	W3 (25 Years)	W3 (25 Years)
Categorization by Climatic Zone	S (severe)	S (severe)
Categorization by Imposed Loads	Concrete/Steel P3: TH2-TH1 P2: TH4-TH3	Concrete/Steel P3: TH2-TH1 P2: TH4-TH3
	PU Insulation P2: TH4-TH1	PU Insulation P2: TH4-TH1
Categorization by Roof Slope	S1 (<5%) TO S4 (>30%)	S1 (<5%) TO S4 (>30%)
Categorization by Surface Temperature	Lowest: TL4 (-30°C)	Lowest: TL4 (-30°C)
	Highest: TH4 to TH1 (90°C to 30°C)	Highest: TH4 to TH1 (90°C to 30°C)
Resistance to Wind Loads	≥ 50 kPa	≥ 50 kPa
Statement on Dangerous Substances	NPD	NPD



Substrate Requirements



Before Application Checklist

Ensure the surface is clean, dry, and free from contaminants before application.

Moisture Content

Before application, check the substrate's moisture content, humidity, and dew point using a moisture meter.

The moisture content must not exceed 5%.

No rising moisture should be present, confirmed by ASTM D 4263 (Polyethylene sheet test).

Ambient and Surface Temperature

Ensure both ambient and surface temperatures are:

- Minimum: +5°C
- Maximum: +35°C

Be mindful of condensation; the substrate should be at least 3°C above dew point.

Application must not take place when the relative humidity is in excess of 95%, or in fog. The temperature/ humidity must be such that there is no risk of surface condensation occurring before or during application

General Surface Preparation



Ensure the surface is clean, dry, and free from contaminants before applying the Lava 20 System.

General Cleaning:

Use a power washer or broom to remove dirt debris.

Degreasing:

For grease contaminated surfaces, use a suitable degreasing cleaner to remove any grease etc. (Alkaline degreaser).

Repair/ Filling/ Levelling:

For uneven or damaged surfaces, patch and repair with Owl Super PU Mastic or sand + Lava 20 fast primer to provide a uniform substrate.



Substrate Preparation

Concrete, Metals

- New concrete, metal must cure for at least 28 days.
 - Use of bond breaker tape is possible for excessive movement.
 - Surfaces may need abrasive cleaning to provide a solid substrate, and all surface irregularities should be smoothed out.
 - Repair spalls and voids before applying the primer coat. Any surface defects over 4 mm in depth should be repaired to prevent ponding.
 - For concrete with compressive strength below 25 MPa and cohesive bond strength under 1.5 MPa, consult Owl Waterproofing Solutions for advice on surface preparation.
-

Timber/ Plywood/ OSB

- New or existing timber/ plywood/ OSB should have a moisture content under 6%.
 - Ensure plywood meets the PS1 product standard and is marked with grade trademarks.
 - Fill & smooth joints and gaps with Owl PU Mastic.
 - Reinforce joints with the first coat of Lava 20, followed by 4 inch tape/ 6 inch tape/ 1 meter mesh, followed by another layer of Lava 20.
 - Use of Bond Breaker tape is possible (masking tape underneath joints).
-

Asphalt/ Bituminous Membranes

- Replace or repair any damaged areas of the existing membrane and underlying layers.
- On smooth membranes, remove loose coatings and liquify the surface using a torch, applying dry silica sand. Conduct adhesion tests for compatibility.
- For granule and gravel-surfaced membranes, clean, vacuum or use a power washer. On gravel-surfaced membranes, thoroughly clean the surface and remove ridges and high points to create a smooth surface to apply on.
- Do not apply over asphalt based surfaces that hasn't aged at least 160 days.



Substrate Preparation

Single Ply (PVC)

- Replace or repair any damaged or saturated sections of the roofing membrane and underlying assembly.
 - Wipe the single-ply surface with Lava 20 cleaner & PVC primer & allow to dry.
 - Adhesion tests are recommended to ensure compatibility before proceeding with the project.
-

Single Ply (TPO/EPDM)

- Replace or repair any damaged or saturated sections of the roofing membrane and underlying assembly.
 - Prime the single-ply surface with Lava 20 TPO/ EPDM Primer & allow to dry.
 - Adhesion tests are recommended to ensure compatibility before proceeding with the project.
-

Other Substrate Surfaces

- Contact Owl Waterproofing Solutions for recommendations on preparing any other substrate surfaces.



Substrate Levelling, Patching & Repairing



Owl PU Mastic polyurethane sealant is suitable for filling gaps, voids, joints and waterproofing details etc.

Preferred Materials

Lava 20 Fast Primer & silica sand is recommended for leveling, patching, and repairing substrate cracks and surfaces.

Cementitious repair materials can be used for repairs.

Surface Requirements:

Ensure the substrate is clean, dry and relatively smooth.

Primer & Sand:

Lava 20 Fast Primer/ Owl Universal 2 Part Epoxy Primer with sand patching mix allows patching as part of the priming process. The membrane can be applied once the primer is fully dried.

It is also recommended for repairing concrete and masonry surfaces, and for making slopes to address drainage issues.

Sand Aggregate Specifications:

Keep sand dry. Sand and primer mixing ratio is 1:3

Repairing and Waterproofing Details

Corners, joints, upstands and crack etc. can be repaired with these steps:

1. Fill & smooth voids with Owl PU Mastic.
2. Apply Lava 20 Primer
3. Use Lava 20 + Reinforcing mesh and coat with more Lava 20 or, use Lava Detail 20, followed by reinforcing mesh followed by more Lava 20 or Lava Detail 20.

Structural joints should always be fully reinforced with mesh. Other details like outlets, pipes should also be reinforced with Lava Detail 20 or Lava 20 followed by mesh.



Primer

Always Use a Suitable Primer for Your Substrates

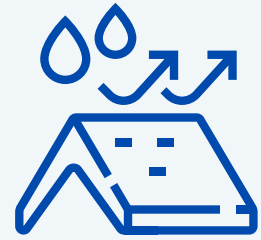

If the concrete substrate has a compressive strength of at least 25MPa and a cohesive bond strength of 1.5MPa, no primer is required.

No Primer Needed:

Use Lava 20 Fast Primer or Owl Universal 2 Part Epoxy Primer.

Concrete, Wood/ Timber, Metals

Apply Lava 20 Fast Primer/ Owl Universal 2 Part Epoxy Primer.

For TPO / EPDM Substrate:

Use Lava 20 TPO & EPDM Primer.

For PVC Substrate:

Use Lava 20 Cleaner & PVC Primer and wipe surface. This primer can also be used as a thinner while using Lava 20 for spray and cleaning tools etc.

Mixing of Epoxy Primer

- Owl Universal 2 Part Epoxy Primer components A and B should be mixed for 4-6 minutes.
- Let the mixture rest for 10 minutes, **then dilute it with 20-25% clean water to regulate viscosity and continue mixing.**

Ensure thorough mixing throughout, especially at the coating sides and bottom until the material is mixed properly and consistent throughout the can.

Application of Primer

Substrate Conditions:

- Lightly apply Primer with a roller, ensuring full wetting of the substrate while avoiding puddling or using excessive amount of primer.



Waterproofing with Lava 20 Polyurethane Coating System



Accelerating Cure & Thicker Applications

When applying Lava 20 add appropriate amount of Lava 20 Catalyst to the mixture to speed up curing. Mix thoroughly for 3 minutes.

For thicker layers use full appropriate size of Lava 20 Catalyst. This will speed up the drying time also.

Step-by-Step Application:

- **Step 1:** Apply Lava 20 onto the prepared and primed surface. Use a roller, brush, or airless spray to apply at a rate of 0.9 kg/m². If reinforcement is needed, apply Lava 20 Polyester Fabric/ Chopped Strand Matting.
- **Step 2:** After 24 hours (and no more than 48 hours), apply a second layer of Lava 20 at the same rate (0.9 kg/m²). If Lava 20 Polyester Fabric/ Matting was used in step 1, repeat this step, applying additional layers at 0.6-0.9 kg/m².
- **Step 3:** Allow 24 hours for curing before applying the Optional Topcoats.

Reasons for Bubbles

- Not reinforced & applied too thick in one pass and still outgassing.
- Primer not dried underneath.
- Not the right ratio of Catalyst or not mixed correctly
- Substrate moisture content.
- Contamination

Avoiding Bubbles

For optimal mixing, the Lava 20 liquid membrane and catalyst should be blended using a low-speed, high-torque mixing drill with a suitable mixing paddle.

Lava 20 Coverage (with Catalyst and Fleece):

- A 25 kg of Lava 20, when used with full catalyst and fleece, can cover a maximum of 10.90 sq m.
- For practical purposes, aim for coverage areas like 11.15 sq m or 11.61 sq m, but do not exceed the maximum limit, stated above to avoid bubbles.





Waterproofing with Lava 20 Polyurethane Coating System



Lava 20 (with Full Catalyst, No Fleece):

- The minimum required application is 1.5 kg per 1 m² when using Lava 20 with a full catalyst but without fleece.
- Coverage can range from 1.5 m² to 2 m², but should never be less than 1 m².

Lava 20 (No Catalyst, No Fleece):

- When applied without catalyst and fleece, use a minimum of 900 grams per 1 m².
- Recommended coverage should range from 1 m² to 1.5 m², ensuring not to apply less than 1 m².

Minimum Layer Thickness

The assembled system should have a minimum thickness of 1.0 mm without an internal mesh.

When an internal mesh is used, the layer thickness should be at least 1.2 mm.

Surface Temperature Guideline

Temperature Range:

- The surface temperature should be between 5°C and 36°C.

Application Conditions:

- It is suitable to apply the product when the temperature is above 5°C and below 36°C, and the surface is clean and dry.
- Low temperatures will slow the curing process, while higher temperatures will accelerate it.
- High humidity may affect the final finish/ drying time.
- Application on a cold surface is acceptable as long as there is no dew or condensation present. However, drying time will be slightly longer in colder conditions.





Waterproofing with Lava 20 Polyurethane Coating System



Mixing Lava 20 with Catalyst

Catalyst Usage:

- In colder temperatures, it is advisable to use a catalyst to speed up the curing process, especially if a faster cure is needed.
- It also helps to cure faster in case of thicker application & wet on wet use of fleece reinforcement.

Note: Termination of Waterproofing System

Always finish/ terminate the waterproofing systems edge/ perimeter appropriately using flashings, cappings, termination bars or raised edges or drip edges etc.

Re-coating:

If outside 48 hours since the last application of Lava 20 system, we recommend cleaning the surface with a solvent cleaner (Xylene, Acetone, Lava 20 Cleaner & PVC Primer) and then lightly prime again.

This will ensure intercoat adhesion.



Applications of Top Coats



Preparation:

Thoroughly stir Lava 20 Clear/ Coloured Top coat before use.

Benefits

- Durable
- Lasts longer
- Zero Degradation
- Easier to Clean
- Flexible
- Optional Anti Slip Finish
- Great Hiding Power
- UV Stable
- Waterproof
- Great Coverage
- Aliphatic
- Sticks to almost any surfaces

Typical Top Coat Applications

Lava 20 Top Coats can change the look and longevity of your roofs, balconies etc. It can be applied over the Lava 20 System and can be used on Lava 20, Lava 20 Vertical, Lava Detail 20 and same or other Lava 20 Top Coats. Popular examples are Dark Grey Top or White Top Coat.

Type. 1 Application of Top Coats Only

(No Sand or Quartz)

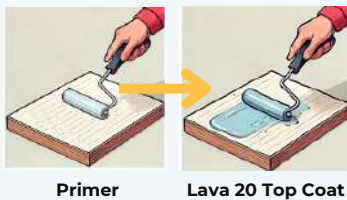

Primer

Lava 20 Top Coat

Apply top coats using a brush or roller or sprayer.

Consumption rate: 0.2 kg/m²

Apply Lava 20 Top Coat over the primed surface using a roller or a trowel. Do not apply layers thicker than 1 mm of dry film to avoid complications during curing. The ideal application and curing temperature are between 5°C and 35°C.

Type. 2 Application of Lava 20 Top Coat with Quartz for an Anti Slip Finish

(High traffic areas, balconies, walkways, car parks etc.)



Light Coat
Cov. Rate: 0.2 kg/m²

Quartz

Heavy Coat
Cov. Rate: 0.4 kg/m²

You can create a functional anti slip finish with Clear Top Coat and any colour quartz or sand or you can use the Lava 20 coloured Top Coats with sand or quartz. Lava 20 Top Coat and quartz adds a durable anti slip finish for demanding traffic areas such as balconies, terraces & high traffic decks etc.

Apply the first coat which is a light layer of Lava 20 Top Coat (coverage rate 0.2 kg/m²) over the primed surface using a roller or trowel. While still wet, evenly sprinkle quartz onto the surface to stick. Allow it to dry (drying takes from 30 minutes to 2.5 hours depending on temperature), then apply another heavier coat of Lava 20 Top Coat to fully seal & encapsulate the quartz, allow to dry to complete.

Coverage Rate

- Light coat: 0.2 kg/m²
- Heavy coat: 0.4 kg/m²

*(Coverage rate can vary on smooth or rough surfaces)



Applications of Top Coats



Type. 3 Lava 20 Primer & Top Coat Only

It is possible to use the Lava 20 Top Coats as a protective coating or high quality paint system that last longer than traditional paints. You can apply Lava 20 Top Coats on most surfaces. First, prime the surface and allow it to dry before applying Lava 20 Top Coats. Please note that this application is not covered under Owl Waterproofing 25 year warranty. To achieve the 25 Year Warranty you must use Lava 20 as specified.

Slip Risk Assessment (Pendulum Test Result for Lava 20 Anti Slip System)

Slip resistance is measured using Pendulum Test Values (PTV)

Standard recognised industry values are:

- 24 PTV and below = High slip risk (1 in 20 or higher chance of slipping)
- 25–35 PTV = Moderate slip risk (1 in 200 chance of slipping)
- 36 PTV and above = Low slip risk (1 in 1,000,000 chance of slipping)

Lava 20 Anti-Slip System Results:

- Dry: PTV 66 – Extremely low slip risk
- Wet: PTV 64 – Still extremely low slip risk

With Lava 20, the probability of slipping is nearly zero, even in wet conditions.

Temperatures Info & Material Storage



Working Life

25 Years +

Storage

Store products in a cool/ dry place and away from direct sunlight.

Temperature range: 0°C to 35°C





Temperatures Info & Material Storage



Safe Surface

Temperature to Apply On

5°C to 35°C

Extreme

Temperatures that it can Withstand

-30°C to 90°C

Storage of Chemical Solutions:

Store all materials as per the Material Safety Data Sheets (MSDS) and local fire and regulatory authority requirements.

Avoid Overloading:

Do not overload structure with past weight load.

Application Considerations:

- **Cold Conditions (2°C - 5°C)** : Application is possible but it will have longer drying time.
- **Hot Conditions (above 35°C)** : Application is possible but not ideal as there is a risk of blistering due to vapor releasing from substrate and reduced working times.

To optimize curing: Store materials in a warm location until use in cold weather, or in a cool location until use in hot weather.

Fire Safety:

Keep Owl Lava 20 products away from ignition sources such as fire, sparks, and flames.

No Smoking: Avoid smoking near the material and the storage area.

MSDS Availability:

Ensure Material Safety Data Sheets (MSDS) are available on-site for all materials.

Read container labels for additional safety and handling information.

All MSDS/ SDS are always accessible online:



Safety Guidelines



Ventilation: Ensure adequate ventilation during application to avoid inhalation of fumes.
If ventilation is poor use carbon masks and PPE.

Personal Protective Equipment (PPE): Wear protective clothing, gloves, chemical splash goggles, safety shoes, overalls, hardhats, and safety harnesses.

Professional Handling: These products should only be handled and applied by trained professionals.
Maintain copies of all relevant Material Safety Data Sheets (MSDS/ SDS) on-site for each component.
Ensure that all crew members are trained on the safety information and procedures for the chemicals they will be working with, and that they understand first-aid procedures for accidents.

Compliance with Safety Regulations: Follow your local safety regulations and building codes.
It is the applicator's responsibility to comply with all relevant laws and safety standards.

Slippery Surfaces: Be aware that coated areas can become extremely slippery when wet. Consider Lava 20 with an Anti Slip finish for traffic area.

For more detailed information, refer to the Product Data Sheets (TDS) and Material Safety Data Sheets (MSDS), or contact Owl Waterproofing Solutions at info@owlwaterproofing.co.uk
or For U.S.A. : www.owlwaterproofing.com/technical-data-resources/
For Ireland/ UK/ Europe: www.lava20waterproofing.com/technical-data-resources/





OWL WATERPROOFING SOLUTIONS

Date: 15. 12. 2022 – V.23
TECHNICAL DATA SHEET

LAVA 20 FAST PRIMER

Solvent Based, Quick Drying, Polyurethane Primer

Product Description

Lava 20 Fast Primer is a transparent durable, deeply penetrating, quickly drying, and rapidly curing polyurethane primer.

Product Information

Chemical Base	Ground and air moisture-cured single-component polyurethane solvent-based primer.
Packaging	1, 4 kg metal pails
Colour**	Brown - yellow
Shelf Life	12 months from the date of production

Consumption

The coverage rate of **0.200 kg/m²** applies to a single layer when applied with a roller on a smooth surface under ideal conditions. Variables such as surface porosity, temperature, humidity, application technique, and the desired finish can affect the actual consumption.

Main Uses

Mostly used on porous surfaces such as concrete, masonry, gypsum, and timber as a primer for polyurethane waterproofing varnishes and polyurethane joint adhesives.

Advantages

- Offers high tensile and impact strength.
- Easy to apply (roller or brush).
- Dries quickly.
- Penetrates deeply.
- Anchors well to porous surfaces
- Provides resistance to excessive moisture.
- Heat and frost resistant.
- Prevents the formation of dust.
- Chemically resistant.

Storage

- Pails should be kept in cool, dry areas, away from moisture and direct sunlight.
- The recommended storage temperature is between **5°C and 35°C**.
- Ensure products are stored in their original, sealed containers, clearly labeled with the manufacturer's name, product designation, batch number, and application precaution details.



OWL WATERPROOFING SOLUTIONS

Technical Data*

Property	Results	Test Method
Composition	Polyurethane pre-polymer. Solvent-based	
Adhesion to concrete	>2.5 N/mm ² (concrete failure)	EN 1542
Resistance to water pressure	No leak (1m water column, 24h)	DIN EN 1928
Service temperature	-30°C to +90°C	Inhouse lab
Application temperature	5°C to 35°C	Conditions: 20°C, 50% RH
Tack free time	1 hour	Conditions: 20°C, 50% RH
Overcoating life	<1 hour	Conditions: 20°C, 50% RH
Final curing time	7 days	Conditions: 20°C, 50% RH

Application

Surface Preparation

1. **Clean the Surface:**

Make sure the surface is clean, dry, and in sound condition. Remove any pollutants such as dirt, grease, oils, organic matter, or old coatings that may compromise the membrane's adhesion.

2. **Check for Moisture:**

The moisture content of the surface should not exceed 5%. You can use a moisture meter to confirm this.

3. **Test Substrate Strength:**

The substrate should have an impact strength of at least 25 MPa and a viscous bond strength of at least 1.5 MPa to ensure it can hold the waterproofing system.

4. **Allow New Concrete to Cure:**

If you are working on new concrete structures, ensure they have cured for at least 28 days before applying any primer or membrane.

5. **Grind the Surface & Remove Grinding Dust:**

Use a grinding machine to remove any loose or old coatings, grime, grease, oils, and other contaminants. Grinding will also smooth out any imperfections on the surface. After grinding, thoroughly clean the surface to remove any dust or loose fragments that could prevent proper adhesion of the membrane.

WARNING: Avoid Water and Metal-Ball Blasting: Do not wash the surface with water, as this can affect the surface's readiness for the primer. Also, avoid using metal-ball blasting equipment since the impact can damage the cohesiveness and durability of the concrete.



OWL WATERPROOFING SOLUTIONS

Priming

1. **Apply Lava 20 Fast Primer:**

Using a roller or brush, evenly apply Lava 20 Fast Primer to cover the entire surface. Make sure all areas are fully coated.

2. **Consider Airless Spraying:**

If available, you can use an airless spray system to apply the primer, which will save labour and time.

3. **Monitor Tacky Primer Stage:**

Once the primer is applied, wait until it becomes slightly tacky. This is the optimal moment to move to the next step.

4. **Apply Polyurethane Coating/Sealant:**

While the primer is still tacky, apply the polyurethane coating or joint sealant to ensure proper adhesion between the layers.

RECOMMENDATION: For surfaces that are extremely brittle, such as lightweight concrete or highly porous cement screed, it is advised to apply two coats of Lava 20 Fast Primer.

Safety Measures

Lava 20 Fast Primer contains isocyanates. See information supplied by the manufacturer. Flammable. Please study the Safety Data Sheet. **PROFESSIONAL USE ONLY.**

Our technical advice for use, whether verbal or written, is given in good faith and reflects the current level of knowledge and experience with our products. When using our products, a detailed object-related and qualified inspection is required in each case to determine whether the product and /or application technology in question meets the specific requirements and purposes. We may guarantee only that our products are compliant with their technical specification; correct application of our products therefore falls entirely within your scope of liability and Users are responsible, in any case, for complying with local legislation and for obtaining any required approvals or authorizations, when necessary, either for their purchase and/or for their use. Values in this technical data sheet are given as examples and may not be regarded as specifications. The new edition of the technical data sheet supersedes the previous technical information and renders it invalid. It is therefore necessary that you always follow the current code of practice. *All values represent typical values and are not part of the product specification. **: The applied sealant might yellow and/or fade upon UV exposure.



OWL WATERPROOFING SOLUTIONS

Date: 21. 12. 2022 - V. 22
TECHNICAL DATA SHEET

LAVA 20 CLEANER & PVC PRIMER

Solvent / Thinner / Diluting Agent

Product Description

Lava 20 Cleaner & PVC Primer acts as a solvent and diluent specifically formulated for compatibility with the Lava 20 System & Lava 20 liquid rubber waterproofing membranes.

Product Information

Chemical Base	One-component, solvent / thinner
Packaging	1 L, 5 L metal pails
Colour	Transparent

Advantages

- Offers exceptional compatibility with single-component polyurethane liquid-applied waterproofing membranes and coatings.
- Provides excellent solubility.
- Suitable for both manual and airless spray applications.

Main Uses

- Mainly used as a solvent/ diluting agent
- Applied alongside Lava 20/ Lava Detail 20/ Lava Vertical liquid rubber waterproofing membranes.

Application

Combine Lava 20 Cleaner & PVC Primer with Lava 20 liquid rubber waterproofing membrane and thoroughly mix using a low-speed electrical mixer for 2-3 minutes, maintaining a ratio of 4-8% by weight. For more detailed application guidelines, please consult our technical department.

Safety Measures

Lava 20 Cleaner & PVC Primer contains methyl ethyl ketone and is flammable. Refer to the manufacturer's information and review the Safety Data Sheet carefully. For professional use only.

Our technical advice, whether provided verbally or in writing, is offered in good faith and reflects our current knowledge and experience with the products. However, when using our products, a thorough and case-specific assessment is necessary to ensure that the product and/or application method meets the unique requirements of the project. We guarantee only that our products conform to their technical specifications. Proper application remains the user's responsibility, and it is essential to adhere to local regulations and obtain any required permits or authorizations as necessary for both the purchase and use of the products.

The values listed in this technical data sheet are intended as examples and should not be interpreted as definitive specifications. For precise product specifications, please consult our technical department. This updated technical data sheet supersedes any prior versions, rendering them invalid. Therefore, it is crucial to always reference the most current documentation.



OWL WATERPROOFING SOLUTIONS

Date: 20. 12. 2022 - V. 22
TECHNICAL DATA SHEET

LAVA 20 EPDM & TPO PRIMER

Bonding Agent for EPDM and TPO Membranes

Product Description

Lava 20 EPDM & TPO Primer is a clear, single-component bonding agent designed to activate TPO and EPDM surfaces, ensuring strong adhesion for subsequent coatings. It is solvent based.

Product Information

Chemical Base	Single-component bonding agent
Packaging	1 kg, 4 kg metal pails
Colour	Transparent
Shelf Life	12 months from the date of production

Main Uses

Lava 20 EPDM & TPO Primer is primarily used as a bonding agent (primer) for applying Lava 20 liquid rubber waterproofing coatings on TPO and PP membranes.

Application

Surface Preparation:

1. **Thorough Cleaning:** Proper surface preparation is crucial for achieving a durable and high-quality finish. Ensure the surface is clean, structurally sound, and free from contaminants that may hinder adhesion.
2. **Removal of Contaminants:** Eliminate old coatings, dirt, grease, oils, organic materials, and dust. The moisture content should not exceed 5%. Loose debris and sanding dust must be completely removed. Avoid washing the surface with water.

Priming (Surface Activation):

1. **Ideal Conditions:** For optimal results, apply in temperatures ranging from 5°C to 35°C, with relative humidity between 50% and 70%. Low temperatures or humidity will slow down the curing process.
2. **Primer Application:** Soak a clean, dry cloth with Lava 20 EPDM & TPO Primer and wipe down the entire surface, changing clothes frequently. This ensures both chemical activation and effective degreasing of the surface. Ensure full coverage without missing any areas.
3. **Coating Application:** After 2-3 hours, proceed with applying the Lava 20 Liquid Rubber Waterproofing Membrane.

Advantages

- Easy to apply
- Outstanding adhesion to TPO-FPO, PP, and EPDM
- UV-resistant
- Fast curing

Consumption

The recommended coverage is **50-60 gr/m²** per single layer.

This estimate assumes application on a smooth, ideal surface under optimal conditions. Factors such as surface porosity, ambient temperature, and the application method may influence the actual consumption.



OWL WATERPROOFING SOLUTIONS

Storage

Pails must be kept in cool, dry storage conditions for a maximum of 12 months. Protect the material from exposure to moisture, freezing temperatures, and direct sunlight. Store at temperatures between 5°C and 35°C. Always keep the products in their original, unopened packaging, ensuring the manufacturer's name, product details, batch number, and safety instructions are visible on the labels.

Safety Measures

Review the Safety Data Sheet. Professional use only.

Our technical guidance, whether provided verbally or in writing, is offered in good faith and reflects the most up-to-date knowledge and experience with our products. However, when using our products, it is essential to conduct a detailed, project-specific assessment in each case to ensure that the product and/or application method meets the specific needs and requirements. We can only guarantee that our products conform to their technical specifications. The correct application of our products is entirely the user's responsibility, and users must comply with all applicable local regulations and obtain any necessary permits or approvals for both the purchase and use of the products. The values provided in this technical data sheet are indicative and should not be considered as specifications. For detailed product specifications, please reach out to our R&D department. This edition of the technical data sheet replaces any previous versions, which are no longer valid. Therefore, it is important to always refer to the most current version of the document.

*Please note that all values are typical and are not considered part of the product specifications.



OWL WATERPROOFING SOLUTIONS

LAVA 20 UV PRIMER

Date: 24. 11. 2023 - V. 23
TECHNICAL DATA SHEET

Bonding Agent for Glass & Glossy Surfaces

Product Description

Lava 20 UV Primer is a clear, single-component bonding agent designed to chemically activate ceramic and glass surfaces, ensuring strong adhesion for subsequent coatings. It is solvent-based and cures through a reaction with moisture from the ground and air.

Product Information

Chemical Base	Single component bonding agent
Packaging	1 kg, 5 kg Metal pails
Colour	Transparent
Shelf Life	9 months from the date of production

Main Uses

- Polished ceramic tiles
- Glass surfaces
- Glass bricks, and more.

Lava 20 UV Primer can also be combined with Lava 20 System for application on glass surfaces.

Application

Surface Preparation

Proper surface preparation is critical for achieving the best finish and long-term durability. The surface must be free of contaminants like old coatings, dirt, oils, fats, organic substances, and dust that could negatively impact adhesion.

Moisture Limit: The surface moisture content should not exceed 5%.

Ensure all loose particles and dust from grinding are completely removed. Avoid cleaning the surface with water.

Priming (Surface Activation)

Optimal Conditions: For ideal results, apply the primer in temperatures between 5°C and 35°C, with relative humidity levels between 50% and 70%. Low temperatures and humidity can slow down the curing process, while high humidity may alter the finish.

Application: Use a clean, dry cloth to apply Lava 20 UV Primer by wiping down the entire surface. Change cloths frequently to ensure effective surface activation and degreasing. Make sure the primer is applied evenly, leaving no untreated areas. After 1-2 hours, apply Lava 20.

Advantages

- Easy to apply
- Superior surface quality
- UV-resistant
- Fast curing
- Effectively degreases the surface

Consumption

Apply 50-80 gr/m² in one or two coats.

This coverage estimate relies on application with a roller on a smooth surface under optimal conditions. Variables such as surface porosity, temperature, and application technique may affect actual consumption.

Certifications

EN1504-2: Concrete surface protection within the system. Performance is assessed as part of the system.





OWL WATERPROOFING SOLUTIONS

Safety Measures

Lava 20 UV Primer contains isopropanol. Refer to the manufacturer's information and review the Safety Data Sheet. For professional use only.

Our technical advice, whether provided verbally or in writing, is given in good faith and reflects the current knowledge and experience we have with our products. However, before using our products, a thorough, case-specific evaluation must be conducted to ensure that both the product and the application method meet the particular requirements of your project. We can only guarantee that our products comply with their technical specifications; the correct application is the full responsibility of the user. Users are also responsible for adhering to local regulations and obtaining any necessary permits or approvals for the purchase and/or use of the products. The values listed in this technical data sheet are provided as examples and should not be considered as specifications. For exact product specifications, please contact our technical department. The latest edition of the technical data sheet replaces any previous versions, which are no longer valid. It is essential to always refer to the current guidelines.

*Please note that all values represent typical figures and are not part of the product's specifications.



OWL WATERPROOFING SOLUTIONS

OWL UNIVERSAL 2-PART EPOXY PRIMER

Date: 20. 12. 2022 - V. 22
TECHNICAL DATA SHEET

Water Based Epoxy Primer

Product Description

Owl Universal 2-Part Epoxy Primer is a transparent, durable epoxy primer designed for waterproofing, sealing, and floor coating applications. It can be applied to non-absorbent, semi-absorbent, and absorbent surfaces. Verified as a reliable barrier to water vapor, the primer hardens through the chemical bonding of its two components.

Product Information

Chemical Base	2 -component water based epoxy primer
Packaging	3+1 kg metal pails
Colour	Pale yellow
Shelf Life	12 months from the date of production

Main Uses

Owl Universal 2 Part Epoxy Primer is primarily designed to serve as a primer and vapor barrier for polyurethane waterproofing coatings, polyurethane joint sealants, and polyurethane or epoxy floor coatings. It is compatible with a wide range of surfaces, including non-absorbent, semi-absorbent, and absorbent materials, such as:

- Concrete or polished concrete
- Wood
- Various metals
- Asphalt
- Bituminous membranes
- Ceramic tiles
- Glass
- Aged acrylic coatings, etc.

It can also function as a tack coat when required.

Advantages

- Easy to apply with either a roller or brush
- Low odour formulation
- Provides strong adhesion to both absorbent and non-absorbent surfaces
- Can be applied to damp surfaces without compromising adhesion
- Resistant to standing water
- Water-dilutable
- Offers high tensile strength and impact resistance
- Resistant to extreme temperatures, including heat and frost
- Prevents dust formation
- Chemical resistant
- Acts as a vapor barrier when applied at the specified rate (Class III).

Consumption

- 0.100 - 0.200 kg/m² applied in one or two coats as a primer
- 0.600 kg/m² applied in three coats as a primer and vapor control barrier

These coverage rates are based on practical application using a roller on a smooth surface in ideal conditions. Factors like surface texture, temperature, humidity levels, application method, and the desired finish can influence the actual product usage.



OWL WATERPROOFING SOLUTIONS

Technical Data

PROPERTY	RESULTS	TEST METHOD
Composition	Epoxy resin + Hardener. Water based	
Mixing Ratio	A:B = 3:1	
Adhesion to aluminum	>2 N/mm ²	EN 1542
Adhesion to concrete	>4.5 N/mm ²	EN 1542
Hardness (Shore A Scale)	>95	ASTM D 2240
Resistance to Water Pressure	No Leak (1m water column, 24h)	DIN EN 1928
Service Temperature	-30°C to +90°C	Inhouse lab
Pot Life	45-50 min	Conditions: 20°C, 50% RH
Overcoating time	6-12 hours	Conditions: 20°C, 50% RH
Final Curing Time	7 days	Conditions: 20°C, 50% RH
Application Temperature	10°C to 35°C	Conditions: 20°C, 50% RH

Certifications

EN1504-2: Concrete surface protection product (0.2 kg/m²). Included in ETA21/0248 IETcc (EAD 030350-00-0402).



Application

Surface Preparation

Proper surface preparation is key for achieving a long-lasting and high-quality finish.

The concrete must be free from contaminants like dust, oils, fats, and organic materials that could affect primer adhesion.

Moisture content: The moisture content of the concrete should not exceed 8%. The substrate should have a compressive strength of at least 25 MPa and a cohesive bond strength of at least 1.5 MPa.

Surface cleaning: Remove old coatings, dirt, and any loose material with a grinding machine. Smooth out any surface irregularities. Thoroughly clean the surface of all dust and debris after grinding. For other substrates, contact technical support for guidance.

Caution: Do not use metal-ball blasting machines, as they can damage the concrete's cohesion and reduce its stability.

Mixing

- Component mixing:** Mix Owl Universal 2-Part Epoxy Primer Component A & B using a low-speed mechanical stirrer for 3-5 minutes, following the specified ratio. Ensure the components are fully combined, paying special attention to mixing around the walls and bottom of the container until the mixture is homogeneous.
- Dilution:** Add 15-25% clean water to the mixture to adjust viscosity as needed.

Priming

Application: Use a roller or brush to apply the diluted Owl Universal 2-Part Epoxy Primer, ensuring even coverage. After 6-12 hours, but no later than 24 hours, and while the primer is still slightly tacky, proceed with applying the Lava20 liquid rubber waterproofing system or Owl PU Mastic joint-sealant.



OWL WATERPROOFING SOLUTIONS

Pot life: Ensure the primer is used within its pot life for best results.

Temperature warning: Do not apply Owl Universal 2-Part Epoxy Primer, if the ambient or ground temperature is below 10°C.

Recommendations

Fragile surfaces: For weak or porous surfaces like lightweight concrete or porous cement screeds, apply two coats of Owl Universal 2-Part Epoxy Primer.

Optimal conditions: The best results are achieved when the temperature during application and curing is between 5°C and 35°C. Low temperatures slow the curing process, while high temperatures accelerate it. High humidity may affect the finish.

Storage

Pails must be stored in cool, dry areas. Ensure the material is protected from moisture and direct sunlight. The storage temperature should be maintained between 5°C and 35°C. Keep the products in their original, sealed containers with the manufacturer's name, product identification, batch number, and safety instruction labels intact.

Safety Measures

Owl Universal 2 Part Epoxy Primer includes amines and epoxy resins. Please review the manufacturer's documentation and read the Safety Data Sheet. Professional Use Only.

Our technical advice, whether provided verbally or in writing, is offered in good faith and reflects our current knowledge and experience with the products. When using our products, it is essential to carry out a thorough, project-specific evaluation in each case to ensure that the product and/or application method meets the necessary requirements. We can only guarantee that our products adhere to their technical specifications; the proper application of the products is entirely your responsibility. Users must comply with local regulations and obtain any necessary permits or authorizations for both the purchase and use of the products. The values in this technical data sheet are provided as examples and should not be considered specifications. For specific product details, please contact our technical department. The latest edition of the technical data sheet replaces all previous versions and renders them obsolete, so always ensure you have the most up-to-date guidelines at hand.

*Please note that all values are typical and do not form part of the product specification. The applied primer may experience yellowing or fading when exposed to UV light.



OWL WATERPROOFING SOLUTIONS

OWL PU MASTIC

Date: 16. 09. 2025 - V. 25
TECHNICAL DATA SHEET

Polyurethane Joint Sealer Mastic

Product Description

Owl PU Mastic is a polyurethane based single component dynamically flexible polyurethane mastic designed for caulking joint-sealing adhesive.

Product Information

Chemical Base	Flexible, single-component polyurethane
Packaging	300 ml cartridges 600ml sausages
Colour**	Grey
Shelf Life	12 months from the date of production

Main Uses

Owl PU Mastic is used for:

- Expansion and control joints in concrete, masonry, or precast panels.
- Sealing around windows, doors, and cladding panels where weather resistance is required.
- Interior & exterior joints: For walls, floors, and roofing areas that need a watertight, flexible seal.
- For non-porous materials where strong adhesion and elasticity are necessary.

Advantages

- Easy to apply
- Weather-resistant
- Withstands continuous movement
- Resistant to water, heat, and frost
- Retains mechanical properties within a temperature range of -25°C to +90°C
- Offers strong adhesion to most construction materials
- Resistant to detergents, oils, fuels, and seawater

Consumption

Consumption depends on volume of the joint or crack to be sealed.

Consumption depends on volume of the joint or crack to be sealed.

Use cartridges or sausages within 24 hours of opening.

Do not apply when the temperature is below 5 °C. In cold weather, store the packages at around 20 °C before use.

Avoid using on substrates where moisture-vapor transmission is present, as this may cause bubbling within the sealant.

Technical Data*

PROPERTY	RESULTS	TEST METHOD
Composition	Polyurethane	
Elongation at Break	≥ 600%	DIN 53504
Modulus of elasticity (at 100%)	0.40 N/mm ²	DIN 53504
Tensile Strength	1.2 ± 0.2 N/mm ²	DIN 53504
Hardness (Shore A Scale)	15-25	DIN 53505, ASTM D 2240



OWL WATERPROOFING SOLUTIONS

Application Temperature	5° C to 35° C	Inhouse Lab
Cure Rate (25°C; 50% Relative Humidity)	2 mm/ 24 hour	Inhouse Lab
Chemical properties	The product is a single-component, thixotropic sealant that can be easily applied using a manual or pneumatic gun. It cures through the moisture in the air, ensuring bubble-free curing without excessive joint expansion and maintaining its original volume without shrinkage. Once cured, it can be painted over and provides permanent elasticity, delivering long-lasting flexibility. It is highly resistant to weather conditions and water, making it suitable for both interior and exterior applications.	



Application:

Surface Preparation:

- 1. Remove Contaminants & Eliminate Loose Debris:**
Ensure all oils, grease, and other pollutants that could affect adhesion are cleaned from the surface. Clear any excess materials or debris from the surface.
- 2. Concrete Surfaces:**
Ensure concrete is sturdy, fully cured for at least 28 days, and the moisture content does not exceed 5%.
- 3. Surface Testing:**
Before applying the mastic, test a small section for proper adhesion, color compatibility, and chemical resistance.

Tools should be cleaned with alcohol or acetone before the sealant fully cures. Once cured, mechanical abrasion is required for removal.

Movement Joint Sealing for Roof Waterproofing:

- 1. Seal the Bottom of the Joint:**
Use Owl PU Mastic Joint-Sealant to seal only the bottom of the joint.
- 2. Apply Lava 20 Layer:**
Brush a 200mm wide strip of Lava 20 centered over the joint.
- 3. Press Polyester Fabric/ Matting:**
Use a tool to press the polyester fabric/ matting into the Lava 20 layer until it is well saturated, ensuring the joint is completely covered.
- 4. Final Seal with Mastic:**
Apply Owl PU Mastic sealant to the remaining exposed area of the joint and allow it to cure for 12 hours.

Priming

Adhesion Testing: If the adhesion test shows weak adherence, priming is necessary.

- **Absorbent Surfaces:** For surfaces such as concrete, screed, and wood, use Lava 20 Fast Primer to improve adhesion.
- **Non-Absorbent Surfaces:** For surfaces like metal and ceramic tiles, use Lava 20 Epoxy Primer to ensure proper bonding.



OWL WATERPROOFING SOLUTIONS

Sealing

1. Insert Joint Filler:

Press a flexible, non-adhesive polyethylene joint filler into the joint after the primer has dried. Ensure the filler has no holes to prevent air bubbles in the joint.

2. Apply Mastic:

Use Owl PU Mastic with a pneumatic or hand-held special pistol (maximum pressure: 3.5 kg) to fill the joint. Take care to avoid trapping air/ bubbles during application. Use a joint nail or putty knife to smooth the mastic. Apply protective strips to create a clean, professional finish.

Storage

Product should be stored in dry and cool rooms for up to 12 months. Protect the material against moisture and direct sunlight. Storage temperature: 5° to 35° C. Products should remain in their original, unopened containers, bearing the manufacturer's name, product designation, batch number and application precaution labels.

Safety measures

Owl PU Mastic contains isocyanates. See information supplied by the manufacturer. Please study the Safety Data sheet.
PROFESSIONAL USE ONLY

Our technical advice for use, whether verbal, written or in tests, is given in good faith and reflect the current level of knowledge and experience with our products. When using our products, a detailed object-related and qualified inspection is required in each individual case in order to determine whether the product and /or application technology in question meets the specific requirements and purposes. We are liable only for our products being free from faults; correct application of our products therefore falls entirely within your scope of liability and responsibility. We will, of course, provide products of consistent quality within the scope of our General Conditions of Sale and Delivery. Users are responsible for complying with local legislation and for obtaining any required approvals or authorizations. Values in this technical data sheet are given as examples and may not be regarded as specifications. The new edition of the technical data sheet supersedes the previous technical information and renders it invalid. It is therefore necessary that you always have to hand the current code of practice. *All values represent typical values and are not part of the product specification.



OWL WATERPROOFING SOLUTIONS

Date: 16. 09. 2025 - V. 01
TECHNICAL DATA SHEET

LAVA 20 CHOPPED STRAND MATTING (EMULSION BASED)

Emulsion Binder Fiberglass Matting For Strength & Reinforcement

Product Description

Lava 20 Emulsion based Chopped Strand Reinforcing fabric is (180 g/m²) primarily used as a reinforcement material with Lava 20 liquid-applied waterproofing membranes.

Advantages

- Easy to apply
- Strong absorption and compatibility with Lava 20 System.
- High tear resistance
- UV-resistant

Product Information

Chemical Base	Emulsion binder Fiberglass Matting (180 gr/m ²)
Packaging	1.04 m x 50 m length
Colour	White
Consumption	When applied across the entire surface, there should be a 5-10 cm overlap between the matting strips.

Suitability

Lava 20 Emulsion Based Chopped Strand Matting is designed to serve as a reinforcement material for use with Lava 20, Lava 20 Vertical, Lava Detail 20.

Uses

It can be applied over the entire surface to be waterproofed or used selectively in areas such as:

- wall-to-floor junctions
- wall-to-wall intersections
- around pipe outlets and chimney stacks
- light domes and air conditioning units
- waterspouts (siphons)
- 90-degree angles
- within movement joints and over cracks, among others.

Technical Data

Property	Results
Unit Weight	180 ± 6% gr/m ²
Tensile Strength	≥100 N/30cm ²
R20	≤ 0.80%
Moisture	≤ 0.20
Loss of Ignition	3.5 ± 1 %
Wet-out rate	≤ 30 S



OWL WATERPROOFING SOLUTIONS

Application

Reinforcement of Lava 20 Waterproofing Liquid Membrane and Lava 20 Chopped Strand Matting (Emulsion Based):

- Use Lava 20 Chopped Strand Matting (Emulsion Based) to reinforce the Lava 20 liquid membrane, either across the entire surface to be waterproofed or selectively in critical areas such as wall-to-floor junctions, around light domes, chimneys, pipes, and waterspouts (siphons).
- Apply the matting on the still-wet Lava 20 liquid membrane, ensuring it is properly cut to fit. Press the matting to allow it to soak into the membrane, then saturate it further with additional Lava 20 liquid membrane until fully covered.

Crack Repair Before Applying Lava 20 Waterproofing Liquid Membrane:

1. Clean any dust, residue, or contaminants from cracks and hairline fractures in the concrete.
2. Apply Lava 20 Primer locally and allow it to dry for 2-3 hours.
3. Fill the prepared cracks with Owl PU Mastic.
4. Apply a 200mm wide stripe of Lava 20 centred over the cracks. While still wet, place a properly cut strip of Lava 20 chopped strand matting (Emulsion based) over it, pressing it down to ensure it soaks.
5. Saturate the matting thoroughly with more Lava 20 until it is completely covered. Allow it to cure.

Watertight Sealing of Movement Joints Before Applying Lava 20 Waterproofing Liquid Membrane:

1. Clean expansion and control joints of dust, debris, or other contaminants. Widen and deepen the joints if necessary. Apply Owl PU Mastic Joint-Sealant along the bottom of the joint.
2. Brush a 200mm wide stripe of Lava 20 liquid membrane centred over the joint.
3. Place Lava 20 Chopped Strand Matting (Emulsion Based) onto the wet coating and press it deep into the joint using a suitable tool until it is fully soaked and covers the joint interior.
4. Saturate the matting with an adequate amount of Lava 20 liquid membrane.
5. Fill any remaining space in the joint with Owl PU Mastic and allow it to cure.

Storage

Store rolls in a cool, dry area for up to 24 months. Keep the material protected from moisture and direct sunlight. Products should be kept in their original, unopened packaging, labelled with the manufacturer's name, product name, and batch number. For professional use only.

Our technical guidance, whether provided verbally or in writing, is offered in good faith and reflects our current knowledge and experience with the products. However, when using our products, a thorough, project-specific assessment is essential to ensure that the product and/or application method meets the required specifications and intended purposes. We can only guarantee that our products conform to their technical specifications; proper application remains solely your responsibility. Users must also ensure compliance with local regulations and secure any necessary approvals or permits for purchase and use when required. The values stated in this technical data sheet are for reference only and should not be considered specifications. For precise product specifications, please reach out to our technical department. Each new version of this technical data sheet supersedes the previous one, rendering earlier information invalid. Always make sure to refer to the latest code of practice.



OWL WATERPROOFING SOLUTIONS

LAVA 20 POLYESTER REINFORCING FABRIC

Date: 16. 09. 2025 - V. 01
TECHNICAL DATA SHEET

Polyester Geotextile Designed to Reinforce

Product Description

Lava 20 Polyester Reinforcing fabric is a non-woven polyester geotextile (60g/m²) primarily used as a reinforcement material with Lava 20 liquid-applied waterproofing membranes.

Product Information

Chemical Base	Polyester non-woven geotextile (60 gr/m ²)
Packaging	1m x 100m length 1m x 50m length 0.2m x 100m length 0.1m x 50m length
Colour	White
Consumption	When applied across the entire surface, there should be a 5-10 cm overlap between the fabric strips.

Advantages

- Easy to apply
- Strong absorption and compatibility with Lava 20 System.
- High tear resistance
- UV-resistant

Suitability

Lava 20 Polyester Reinforcing Fabric is designed to serve as a reinforcing fabric for use with Lava 20, Lava 20 Vertical, Lava Detail 20.

Uses

It can be applied over the entire surface to be waterproofed or used selectively in areas such as:

- wall-to-floor junctions
- wall-to-wall intersections
- around pipe outlets and chimney stacks
- light domes and air conditioning units
- waterspouts (siphons)
- 90-degree angles
- within movement joints and over cracks, among others.

Technical Data

Property	Results	Test Method
Unit Weight	60 ± 5% gr/m ²	EN12127
Tensile Strength	180 N/5cm MD 150 N/5cm CD	EN 29073-3 EN 29073-3
Elongation at break	50% MD 120% CD	EN 29073-3 EN 29073-3
Thickness	0.26± 15%	ASTM D1777
Shrinkage	1.9% - 2.5%	IN EN 290
Drying Time	6.5"/ sec	
Melting Point	250°C	



OWL WATERPROOFING SOLUTIONS

Application

Reinforcement of Lava 20 Waterproofing Liquid Membrane and Lava 20 Polyester Reinforcing Fabric:

- Use Lava 20 Polyester Reinforcing Fabric to reinforce the Lava 20 liquid membrane, either across the entire surface to be waterproofed or selectively in critical areas such as wall-to-floor junctions, around light domes, chimneys, pipes, and waterspouts (siphons).
- Apply the fabric on the still-wet Lava 20 liquid membrane, ensuring it is properly cut to fit. Press the fabric to allow it to soak into the membrane, then saturate it further with additional Lava 20 liquid membrane until fully covered.

Crack Repair Before Applying Lava 20 Waterproofing Liquid Membrane:

1. Clean any dust, residue, or contaminants from cracks and hairline fractures in the concrete.
2. Apply Lava 20 Primer locally and allow it to dry for 2-3 hours.
3. Fill the prepared cracks with Owl PU Mastic.
4. Apply a 200mm wide stripe of Lava 20 centred over the cracks. While still wet, place a properly cut strip of Lava 20 Polyester Reinforcing Fabric over it, pressing it down to ensure it soaks.
5. Saturate the fabric thoroughly with more Lava 20 until it is completely covered. Allow it to cure.

Watertight Sealing of Movement Joints Before Applying Lava 20 Waterproofing Liquid Membrane:

1. Clean expansion and control joints of dust, debris, or other contaminants. Widen and deepen the joints if necessary. Apply Owl PU Mastic Joint-Sealant along the bottom of the joint.
2. Brush a 200mm wide stripe of Lava 20 liquid membrane centred over the joint.
3. Place Lava 20 Polyester Reinforcing Fabric onto the wet coating and press it deep into the joint using a suitable tool until it is fully soaked and covers the joint interior.
4. Saturate the fabric with an adequate amount of Lava 20 liquid membrane. Insert a polyethylene cord of the appropriate size into the joint, pressing it deep into the saturated fabric.
5. Fill any remaining space in the joint with Owl PU Mastic sealant and allow it to cure.

Storage

Store rolls in a cool, dry area for up to 24 months. Keep the material protected from moisture and direct sunlight. The recommended storage temperature is between 5°C and 35°C. Products should be kept in their original, unopened packaging, labelled with the manufacturer's name, product name, and batch number. For professional use only.

Our technical guidance, whether provided verbally or in writing, is offered in good faith and reflects our current knowledge and experience with the products. However, when using our products, a thorough, project-specific assessment is essential to ensure that the product and/or application method meets the required specifications and intended purposes. We can only guarantee that our products conform to their technical specifications; proper application remains solely your responsibility. Users must also ensure compliance with local regulations and secure any necessary approvals or permits for purchase and use when required. The values stated in this technical data sheet are for reference only and should not be considered specifications. For precise product specifications, please reach out to our technical department. Each new version of this technical data sheet supersedes the previous one, rendering earlier information invalid. Always make sure to refer to the latest code of practice.



OWL WATERPROOFING SOLUTIONS

Date: 16. 09. 2025 - V. 01
TECHNICAL DATA SHEET

LAVA 20 CHOPPED STRAND MATTING (POWDER BASED)

Powder Binder Fiberglass Matting For Strength & Reinforcement

Product Description

Lava 20 Powder based Chopped Strand Reinforcing fabric is (180 g/m²) primarily used as a reinforcement material with Lava 20 liquid-applied waterproofing membranes.

Product Information

Chemical Base	Powder binder Fiberglass Matting (180 gr/m ²)
Packaging	6 in x 50 m length
Colour	White
Consumption	When applied across the entire surface, there should be a 5-10 cm overlap between the matting strips.

Advantages

- Easy to apply
- Strong absorption and compatibility with Lava 20 System.
- High tear resistance
- UV-resistant

Suitability

Lava 20 Powder Based Chopped Strand Matting is designed to serve as a reinforcement material for use with Lava 20, Lava 20 Vertical, Lava Detail 20.

Uses

It can be applied over the entire surface to be waterproofed or used selectively in areas such as:

- wall-to-floor junctions
- wall-to-wall intersections
- around pipe outlets and chimney stacks
- light domes and air conditioning units
- waterspouts (siphons)
- 90-degree angles
- within movement joints and over cracks, among others.

Technical Data

Property	Results
Unit Weight	180 ± 6% gr/m ²
Tensile Strength	≥100 N/30cm ²
R20	≤ 0.80%
Moisture	≤ 0.20
Loss of Ignition	3.5 ± 1 %
Wet-out rate	≤ 40 S



OWL WATERPROOFING SOLUTIONS

Application

Reinforcement of Lava 20 Waterproofing Liquid Membrane and Lava 20 Chopped Strand Matting (Powder Based):

- Use Lava 20 Chopped Strand Matting (Powder Based) to reinforce the Lava 20 liquid membrane, either across the entire surface to be waterproofed or selectively in critical areas such as wall-to-floor junctions, around light domes, chimneys, pipes, and waterspouts (siphons).
- Apply the matting on the still-wet Lava 20 liquid membrane, ensuring it is properly cut to fit. Press the matting to allow it to soak into the membrane, then saturate it further with additional Lava 20 liquid membrane until fully covered.

Crack Repair Before Applying Lava 20 Waterproofing Liquid Membrane:

1. Clean any dust, residue, or contaminants from cracks and hairline fractures in the concrete.
2. Apply Lava 20 Primer locally and allow it to dry for 2-3 hours.
3. Fill the prepared cracks with Owl PU Mastic.
4. Apply a 200mm wide stripe of Lava 20 centred over the cracks. While still wet, place a properly cut strip of Lava 20 chopped strand matting (Powder based) over it, pressing it down to ensure it soaks.
5. Saturate the matting thoroughly with more Lava 20 until it is completely covered. Allow it to cure.

Watertight Sealing of Movement Joints Before Applying Lava 20 Waterproofing Liquid Membrane:

1. Clean expansion and control joints of dust, debris, or other contaminants. Widen and deepen the joints if necessary. Apply Owl PU Mastic Joint-Sealant along the bottom of the joint.
2. Brush a 200mm wide stripe of Lava 20 liquid membrane centred over the joint.
3. Place Lava 20 Chopped Strand Matting (Powder Based) onto the wet coating and press it deep into the joint using a suitable tool until it is fully soaked and covers the joint interior.
4. Saturate the matting with an adequate amount of Lava 20 liquid membrane.
5. Fill any remaining space in the joint with Owl PU Mastic and allow it to cure.

Storage

Store rolls in a cool, dry area for up to 24 months. Keep the material protected from moisture and direct sunlight. Products should be kept in their original, unopened packaging, labelled with the manufacturer's name, product name, and batch number. For professional use only.

Our technical guidance, whether provided verbally or in writing, is offered in good faith and reflects our current knowledge and experience with the products. However, when using our products, a thorough, project-specific assessment is essential to ensure that the product and/or application method meets the required specifications and intended purposes. We can only guarantee that our products conform to their technical specifications; proper application remains solely your responsibility. Users must also ensure compliance with local regulations and secure any necessary approvals or permits for purchase and use when required. The values stated in this technical data sheet are for reference only and should not be considered specifications. For precise product specifications, please reach out to our technical department. Each new version of this technical data sheet supersedes the previous one, rendering earlier information invalid. Always make sure to refer to the latest code of practice.



OWL WATERPROOFING SOLUTIONS

LAVA 20

Date: 01. 12. 2022 - V. 22
TECHNICAL DATA SHEET

Single Component Polyurethane Liquid Waterproofing System

Product Description

Lava 20 is a high-quality, liquid-applied polyurethane membrane designed for durable waterproofing. It is made from pure elastomeric hydrophobic polyurethane resins, providing exceptional resistance to mechanical wear, chemicals, temperature changes, UV rays, and environmental factors.

Product Information

Chemical Base	Single-component, moisture-activated polyurethane that cures through ground and air exposure, applied and cured at low temperatures, and is solvent-based with an aromatic composition
Packaging	1, 6, 15, 25 kg metal pails
Colour**	White, Light Grey
Shelf Life	12 months from the date of production in a cool, dry place, away from moisture and direct sunlight. Always keep it in its original, unopened packaging with proper labeling.

Uses

- Roofs, terraces, and balconies
- Existing bitumen and asphalt felts, TPO, PP, EPDM, PVC membranes, and old acrylic coatings
- Protection of polyurethane foam insulation
- Green Roofs

Advantages:

- Easy application using a roller or airless spray.
- Forms a continuous, seamless membrane with no joints after application.
- Resistant to standing water.
- Withstands both freezing and high temperatures while maintaining mechanical properties.
- Suitable for green roofs as it resists root penetration.
- Bridges cracks up to 3mm, even at temperatures as low as -20°C.
- Allows water vapor to pass through.
- Offers excellent resistance to weather conditions and UV exposure.
- Can waterproof old bitumen and asphalt felts by covering them without the need for removal.
- Resistant to detergents, oils, seawater, and household chemicals.
- If the membrane is damaged, it can be quickly and easily repaired in minutes.

Consumption

Consumption ranges from **1.4 to 2.5 kg/m²** when applied in two or three layers. The coverage depends on correct application using a roller on a smooth surface. Factors like surface porosity, temperature, and application method can affect consumption. Usage will increase if fabric reinforcement is applied.



OWL WATERPROOFING SOLUTIONS

Certifications

European Technical Approval: ETA 22/0640 Usage classifications according to ETAG005 for liquid-applied polyurethane waterproofing systems:

ETA SYSTEMS

SYSTEMS			PERFORMANCE						
Lava 20	Lava 20 Topcoats	Reinforcement Fabric/Matting	Applicable Substrate	Climate	Load Levels	Roof Slope Range	Service Temperature Range		Service Lifespan
							Low	High	
1.80 kg/m ²	0.15 kg/m ²		Concrete / steel and PU	M & S	P1 to P3	S1 to S4	TL4	TH2-TH4	W3 (25 years)
2.30 kg/m ²		60 gr	Concrete / steel and PU	M & S	P1 to P3	S1 to S4	TL4	TH2-TH4	W3 (25 years)
2.40 kg/m ²		110 gr	Concrete	M & S	P3	S1 to S4	TL3	TH4	W2 (10 years)
4.10 kg/m ²		110 gr	Concrete	M & S	P4	S1 to S4	TL4	TH4	W3 (25 years)

EN1504-2: Concrete surface protection (consumption of 1.4 kg/m²). Lava 20 is CE certified and compliant with EN 1504-2 as a "surface protection system for concrete" (consumption of 1.4 kg/m²), (Test Report No. 90-20-0273).

Property	EN1504-2 Class	Test Method
Permeability to CO ₂ :	Sd>50m	EN 1062-6
Water vapor permeability:	Class I: Sd < 5m	EN ISO 7783
Capillary absorption and permeability to water:	$\omega < 0,1 \text{ kg/m}^2 \cdot \text{h}^{0,5}$	EN 1062-3
Adhesion strength by pull-off tests:	$\geq 1,5 \text{ N/mm}^2$	EN 1542

Fully compliant with the ASTM C836 specification. Compliant with BBA & ETA certification 22/ 0640





OWL WATERPROOFING SOLUTIONS

Technical Data*

PROPERTY	RESULTS	TEST METHOD
Elongation at Break	600 %	ASTM D 412
Tear Strength	40 N/mm	ASTM D624 (type B)
Puncture Resistance	350 N	ASTM E154M (0.8mm film)
Tensile Strength	> 4 N/ mm ²	ASTM D 412
Crack Bridging Ability (23oC)	4.4mm	EN 14891
Crack Bridging Ability (-5oC)	3.7mm	EN 14891
Crack Bridging Ability (-20oC)	3.6mm	EN 14891
Water Vapor Permeability	12 g/m ² /day	DIN EN 1931
Adhesion to concrete	>1.9 N/mm ² (concrete surface failure)	EN 1542
Hardness (Shore A Scale)	>65	ASTM D 2240 (15")
Resistance to Root Penetration	Resistant	UNE CEN/TS 14416
Solar Reflectance (SR)	0.87	ASTM E903-96
Solar Emittance (ε)	0.89	ASTM E408-71
Hydrolysis (5% KOH, 7days cycle)	No significant elastomeric change	Inhouse Lab
Service Temperature	- 30 to +90	Inhouse Lab
Shock Temperature (20min)	200 C	Inhouse Lab
Rain Stability Time	3-4 hours	Conditions: 20 C, 50% RH
Light Pedestrian Traffic Time	18-24 hours	Conditions: 20 C, 50% RH
Final Curing time	7 days	Conditions: 20 C, 50% RH
Chemical Properties	Good resistance against acidic and alkali solutions (5%), detergents, seawater and oils.	

Application

Surface Preparation

- Ensure Cleanliness:**
 The surface must be entirely free of any contaminants that could affect the membrane's ability to adhere. This includes dust, dirt, oils, organic matter, and any old, loose coatings.
- Moisture Control:**
 The moisture content of the surface should not exceed 5%. Using a moisture meter is recommended to ensure the surface is dry enough for application.
- Substrate Strength:**
 The substrate's compressive strength should be at least 25 MPa, and its viscous bond strength should be a minimum of 1.5 MPa. This ensures the surface is strong enough to support the membrane and prevent future failure.
- New Concrete Structures:**
 Newly poured concrete must cure for at least 28 days before it is ready for waterproofing application. This allows the concrete to achieve sufficient strength and minimize moisture content.
- Grinding the Surface:**
 A grinding machine should be used to remove all contaminants, such as dust, grime, oils, fats, and old coatings. This also helps to smooth out any surface imperfections, ensuring the membrane can adhere properly.
- Remove Dust and Loose Particles:**
 After grinding, thoroughly clean the surface to remove any grinding dust and loose fragments that could prevent proper adhesion of the membrane.



OWL WATERPROOFING SOLUTIONS

WARNING: Do not wash the surface with water!

Washing with water can increase surface moisture, leading to poor adhesion and potentially compromising the effectiveness of the membrane. Always use dry cleaning methods.

Repair of Cracks and Joints:

1. Prepare and Clean the Cracks:

Clear any debris, dust, residue, or other contaminants from cracks in the concrete. This step is crucial to ensure proper adhesion and effective long-term waterproofing.

2. Prime the Area:

Apply Lava 20 Primer locally over the prepared cracks and let it dry for 2-3 hours to ensure proper bonding.

3. Fill the Cracks:

Fill all the prepared cracks using Owl PU Mastic sealant to ensure a watertight seal.

4. Apply Lava 20 and Reinforce the Cracks:

Apply a layer of Lava 20 over the sealed crack. While the layer is still wet, place a strip of polyester fabric (cut to 200mm wide) directly over the crack, centering it. Press the fabric into the wet Lava 20 until it is fully soaked and adheres properly. Apply another coat of Lava 20 over the fabric to ensure complete coverage. Allow 12 hours for curing.

Repair of Expansion and Control Joints:

1. Clean the Joints:

Remove any debris, residue, or contaminants from the concrete expansion and control joints.

2. Widen and Deepen the Joints (if needed):

If necessary, cut the joints open to widen and deepen them. The depth should be between 10-15 mm. The ratio of the width to depth of the joint should be approximately 2:1 for optimal performance.

3. Seal the Joint Base:

Apply Owl PU Mastic Joint-Sealant only to the bottom of the joint to prevent water infiltration.

4. Apply Lava 20 to the Joint:

Using a brush, apply a 200mm wide stripe of Lava 20 over and inside the joint. Place a strip of polyester fabric over the wet Lava 20, pushing it deep into the joint until it is saturated and the joint is fully covered.

5. Saturate the Fabric with Lava 20:

Apply more Lava 20 to the fabric until it is fully soaked and completely covers the joint. Place a polyethylene cord of the correct size into the joint, pressing it firmly into the saturated fabric.

6. Final Seal:

Fill the remaining open space in the joint with Owl PU Mastic sealant. Do not cover the joint with any additional material. Allow 12 to 18 hours for the joint to cure fully.

Priming

Concrete, cement screed, or wood should be primed with Lava 20 Fast Primer since they are particularly absorbent surfaces. Observe the primer's technical instructions and give it time to cure.

Waterproofing Membrane

1. Apply Lava 20:

Before use, thoroughly stir the Lava 20 to ensure even consistency. Pour Lava 20 over the cleaned and primed surface. Spread it evenly using a roller, brush, or squeegee to cover the entire area. For labour efficiency, consider using airless spray equipment.

2. Reinforce Problem Areas:

Reinforce key areas such as wall-to-floor connections, 90° angles, chimneys, pipes, and waterspouts by using polyester fabric. While Lava 20 is still wet, place a correctly cut piece of polyester fabric over the area and press it to absorb the coating. Apply more Lava 20 on top of the fabric to ensure complete saturation.



OWL WATERPROOFING SOLUTIONS

3. Reinforce the Entire Surface:

For optimal results, reinforce the entire surface with polyester fabric. Overlap fabric strips by 5-10 cm to ensure strong connections between sections.

4. Apply Additional Coats:

After 12 to 18 hours (but no later than 48 hours), apply a second coat of Lava 20. For demanding applications, apply a third layer of Lava 20.

Application Guidelines:

- **Layer Thickness:** Do not apply layers thicker than 0.6 mm (dry film).
- **Temperature:** The ideal temperature for application and curing is between 5°C and 35°C. High temperatures speed up curing, while low temperatures slow it down.
- **Humidity:** Be cautious of high humidity as it can affect the final finish.

5. Catalyst Addition (Optional):

For applications that require thicker layers or enhanced aesthetics, add up to 3% of Lava 20 Catalyst, depending on temperature and humidity conditions. For layers thicker than 0.900 kg/m², the addition of Lava 20 Catalyst is recommended for optimal results.

Finishing

1. Apply Top Coat for Colour Stability:

If a colour-stable, chalk-free surface is required, apply one or two coats of Lava 20 Top Coat over the Lava 20 membrane. If a dark final colour is preferred, the application of Lava 20 Dark Grey Top-Coat is essential to achieve the desired result.

2. For Heavy-Duty Surfaces:

For surfaces exposed to heavy use, such as public pedestrian decks or car parks, apply two layers of Lava 20 Clear Top Coat with Quartz to enhance abrasion resistance.

Consult Technical Instructions:

For detailed application procedures of the various top coats, refer to their respective technical instructions or contact the technical support team for guidance.

WARNING – Prevent Slippery Surfaces:

Lava 20 and Lava 20 SYSTEM should not be applied or used when wet, as this can cause slipperiness. To create an anti-slip surface, sprinkle appropriate aggregates onto the still-wet coating. For further information on creating slip-resistant surfaces or other concerns, contact the support team.

Limitations

Lava 20 is not recommended for use in areas with permanent water immersion. After extended UV exposure, minor chalking or color changes may occur on the surface.

Packaging

Lava 20 is supplied in 25 kg, 15 kg, 6 kg, 1kg metal pails and 250 kg barrels. Pails should be stored in dry and cool rooms for up to 12 months. Protect the material against moisture and direct sunlight. Storage temperature: 5°-30° C. Products should remain in their original, unopened containers, bearing the manufacturer name, product designation, batch number and application precaution labels.

Safety measures

Lava 20 contains isocyanates. See information supplied by the manufacturer. For details and guidance on the safe handling, storage, and disposal of chemical products, users should consult the latest Safety Data Sheet (SDS), which includes information on physical, ecological, toxicological, and other safety-related aspects.
PROFESSIONAL USE ONLY.



OWL WATERPROOFING SOLUTIONS

Our technical advice for use, whether verbal, written or in tests, is given in good faith and reflects the current level of knowledge and experience with our products. When using our products, a detailed object-related and qualified inspection is required in each case to determine whether the product and /or application technology in question meets the specific requirements and purposes. We may guarantee only that our products are compliant with their technical specification; correct application of our products therefore falls entirely within your scope of liability and Users are responsible, in any case, for complying with local legislation and for obtaining any required approvals or authorizations, when necessary, either for their purchase and/or for their use. Values in this technical data sheet are given as examples and may not be regarded as specifications. The new edition of the technical data sheet supersedes the previous technical information and renders it invalid. It is therefore necessary that you always must hand in the current code of practice. All values represent typical values and are not part of the product specification. In sample preparation, the lava 20 Catalyst was used as an acceleration additive. The applied coating might yellow and/ or fade upon UV Exposure.



OWL WATERPROOFING SOLUTIONS

LAVA 20 CATALYST

Date: 23. 12. 2022 - V. 22
TECHNICAL DATA SHEET

Accelerating Additive

Product Description

Lava 20 Catalyst is an accelerating additive for use with the Lava 20, Liquid-applied polyurethane waterproofing membranes.

Uses

Lava 20 Catalyst is mainly used when Lava 20, needs to be applied in very low temperatures or when Lava 20, needs to be applied in combination with polyester fabric in a wet-in-wet application method (higher coating thicknesses in one layer).

Dosage*

Pot Life @20° C, 100ml	20min (3%) - 30min (2%)
Rain stability Time @ 20°C, 1.5 mm coating thickness	3 hours (2%) – 1,5- 2 hours (3%)

Consumption

The mixing ratio of Lava 20 liquid-applied polyurethane waterproofing membranes to Lava 20 Catalyst is:

Lava 20	Catalyst
6 kg	0.18 kg
15 kg	0.45 kg
25 kg	0.75 kg

- If the full catalyst (0.75 kg Catalyst with 25 kg Lava 20) is used, a maximum of 3 mm thick coating in a single coat can be applied and it will be cured within 3 to 5 Hours.
- If no catalyst is used, a maximum of 900 grams/m²
- If not using catalyst, we recommend either a two-coat application or incorporating matting in this scenario.

Advantages

- When used with the Lava 20 System, Lava 20 Catalyst speeds up the smooth curing of the liquid-applied polyurethane waterproofing membranes.
- This enables over-coating to be completed in three hours even in colder climates.
- When combined with polyester fabric using the wet-in-wet application process, Lava 20 Catalyst enables liquid-applied polyurethane waterproofing membranes to be put in thicker layers without creating bubbles.

Packaging

0.18 kg, 0.45 kg, 0.75 kg metal pails.

Pails should be stored in dry and cool rooms for up to 12 months. Protect the material against moisture and direct sunlight. Storage temperature: 5°-35°C. Products should remain in their original, unopened containers, bearing the manufacturer name, product designation, batch number and application precaution labels.

Shelf Life & Packaging

12 months from the date of production.



OWL WATERPROOFING SOLUTIONS

Application

Surface Preparation Guidelines:

- 1. Stir the Membrane:**
Thoroughly stir the Lava 20 liquid rubber polyurethane waterproofing membranes before use.
- 2. Add Catalyst:**
Add the correct amount of Lava 20 Catalyst to the membrane. Use a low-speed mechanical stirrer to mix the Lava 20 Catalyst and the waterproofing membrane according to the specified ratio. Continue mixing for about 3-5 minutes to ensure the components are properly blended. Pay special attention to mixing the sides and bottom of the pail to achieve a fully homogeneous mixture.
- 3. Apply the Mixture:**
Once mixed, pour the solution onto the prepared surface and spread it evenly. Adhere to all application techniques and guidelines specified for Lava 20 liquid rubber polyurethane waterproofing membranes.

Pot Life Warning: Be sure to use the Lava 20 membrane and Catalyst mixture within the recommended pot life to avoid any curing issues.

Safety measures

See information supplied by the manufacturer. Please study the Safety Data Sheet. PROFESSIONAL USE ONLY.

Our technical advice for use, whether verbal, written or in tests, is given in good faith and reflects the current level of knowledge and experience with our products. When using our products, a detailed object-related and qualified inspection is required in each case to determine whether the product and /or application technology in question meets the specific requirements and purposes. We may guarantee only that our products are compliant with their technical specification; correct application of our products therefore falls entirely within your scope of liability and Users are responsible, in any case, for complying with local legislation and for obtaining any required approvals or authorizations, when necessary, either for their purchase and/or for their use. Values in this technical data sheet are given as examples and may not be regarded as specifications. The new edition of the technical data sheet supersedes the previous technical information and renders it invalid. It is therefore necessary that you always hand in the current code of practice. All values represent typical values and are not part of the product specification. In sample preparation, the lava 20 Catalyst was used as an acceleration additive. The applied coating might yellow and/ or fade upon UV Exposure.



OWL WATERPROOFING SOLUTIONS

LAVA 20 VERTICAL

Date: 01. 12. 2022 - V. 22
TECHNICAL DATA SHEET

Liquid Polyurethane Waterproofing Membrane

Product Description

Lava 20 Vertical is a high-quality, semi-viscous, liquid-applied polyurethane membrane offering highly durable elasticity. It is cold-applied and cures at ambient temperatures, providing long-lasting waterproofing.

Product Information

Chemical Base	Single component. Applied and hardened at room temperature. Solvent-containing composition. Cures through ground and air moisture Aromatic polyurethane.
Packaging	6 kg, 15 kg Metal pails
Colour	White/ Light Grey
Shelf Life	12 months from the date of production

Main Uses

Used for flashing in:

- Roofs, terraces, verandas, and balconies.
- Wet areas (under tiles) in spaces like bathrooms, kitchens, balconies, and utility rooms.
- Pedestrian walkways and vehicle traffic decks.
- Green roofs, planter boxes, and flowerbeds.
- Existing bitumen felts, asphalt felts, TPO, and EPDM membranes.
- PVC membranes and older acrylic coatings.
- Protection for polyurethane foam insulation.

Waterproofing for:

- Sloped roofs.

Advantages

- Easy to apply using either a roller or airless spray.
- Semi-viscous consistency ideal for sloped surfaces.
- Formulated from pure elastomeric hydrophobic polyurethane resins, offering superior resistance to mechanical stress, chemicals, thermal changes, and environmental elements.
- Creates a seamless, joint-free membrane when applied.
- Resistant to standing water.
- Withstands both freezing and high temperatures, maintaining mechanical properties from -30°C to +90°C.
- Bridges cracks up to 3 mm, even at temperatures as low as -20°C.
- Allows water vapor permeability, enabling the surface to breathe.
- Delivers excellent resistance to weather and UV exposure.
- Waterproofs old bitumen and asphalt felts by covering them, eliminating the need for removal before application.
- Reflects sunlight effectively, contributing to thermal insulation.
- Resistant to detergents, oils, seawater, and household chemicals.
- Easily repairable in minutes if the membrane suffers mechanical damage.



OWL WATERPROOFING SOLUTIONS

Consumption

1.4-2.5 kg/m² applied over two or three layers.

This coverage is estimated for roller application on a smooth surface under ideal conditions. Factors such as surface porosity, temperature, and the application technique may affect the actual consumption.

When using polyester or matting reinforcement, the consumption will increase.

Certifications

European Technical Approval: ETA05/0197 DIBt

Usage categories as per ETAG005 for liquid-applied polyurethane waterproofing systems:

Working Life Expected	W3 (4.1 kg/m ²)	25 Years
Climate Zone	M and S	All
Imposed Loads	P1 to P4	Very High (maximum load)
Roof Slopes	S1 to S4	<5° to >30°
Lowest Surface Temperature	TL4	-30 °C
Highest Surface Temperature	TH4	+90 °C
Reaction to Fire	Class E, Brooft4, DIN 4102-1, DIN 4102-7	EU Norm
Resistance to Wind Loads	≥ 50 kPa	EU Norm

Working Life Expected	W2 (2.4 kg/m ²)	25 Years
Climate Zone	M and S	All
Imposed Loads	P1 to P3	High
Roof Slopes	S1 to S4	<5° to >30°
Lowest Surface Temperature	TL3	-20 °C
Highest Surface Temperature	TH4	+90 °C
Reaction to Fire	Class E, Brooft4, DIN 4102-1, DIN 4102-7	EU Norm
Resistance to Wind Loads	≥ 50 kPa	EU Norm

EN 1504-2: Products and systems for protecting and repairing concrete structures. Includes definitions, requirements, quality control, and conformity assessment. Part 2: Surface protection system for concrete (1.4 kg/m²).

EN 14891: Liquid-applied waterproof products for use under ceramic tiles affixed with adhesives. Covers requirements, testing methods, conformity evaluation, classification, and designation (1.4 kg/m²).





OWL WATERPROOFING SOLUTIONS

Technical Data*

PROPERTY	RESULTS	TEST METHOD
Elongation at Break	600 %	ASTM D 412
Tensile Strength	> 4 N/ mm ²	ASTM D 412
Water Vapor Permeability (1.4 kg/m ²)	12.5 gr/ m ² /day	EN ISO 7783
Carbon Dioxide Permeability (1.4 kg/ m ²)	1.8 gr/ m ² /day	EN 1062-6
Water Permeability (1.4 kg/ m ²)	0.015 kg/ m ² /h ^{0.5}	EN 1062-3
Resistance to Water Pressure	No Leak (1m water column, 24h)	DIN EN 1928
Adhesion to concrete	1.8 N/mm ²	EN 1542
Crack Bridging Ability (23°C)	4.3 mm	EN 14891
Crack Bridging Ability (-5°C)	3.5 mm	EN 14891
Crack Bridging Ability (-20°C)	3.3 mm	EN 14891
Hardness (Shore A Scale)	>65	ASTM D 2240 (15")
Thermal resistance (80 °C for 100 days)	Passed- No significant changes	EOTA TR-011
UV accelerated ageing, in the presence of moisture	Passed- No significant changes	EOTA TR-010
Resistance after water aging	Passed	EOTA TR-012
Hydrolysis (5% KOH, 7 days cycle)	No significant elastomeric change	Inhouse Lab
Service Temperature	-30° C to +90° C	Inhouse Lab
Shock Temperature (20 min)	200° C	Inhouse Lab
Rain Stability Time	3-4 hours	Conditions: 20 °C, 50% RH
Light Pedestrian Traffic Time	18-24 hours	Conditions: 20 °C, 50% RH
Final Curing Time	7 days	Conditions: 20 °C, 50% RH
Chemical Properties	Good resistance against acidic and alkali solutions (5%), detergents, seawater and oils.	

Application

Surface Preparation

Proper surface preparation is crucial for achieving the best finish and durability. Ensure the surface is clean, dry, and free from any contaminants that might impair the membrane's adhesion.

Moisture and Strength Requirements: Maximum surface moisture content should not exceed 5%. The substrate should have a compressive strength of at least 25 MPa and a cohesive bond strength of at least 1.5 MPa.

New Concrete Structures: Allow newly poured concrete to dry for a minimum of 28 days before application. Loose coatings, dirt, grease, oils, organic materials, and dust should be removed using a grinding machine. Smooth out any surface irregularities. Clear away all loose particles and dust completely.

Caution: Do not clean the surface with water.

Crack and Joint Repair

1. Properly sealing existing cracks and joints is essential for achieving long-lasting waterproofing. Clean the cracks of dust and other contaminants.
2. Prime the area with Lava 20 Fast Primer and allow 2-3 hours for it to dry.
3. Fill the cracks with Owl PU Mastick sealant.
4. Apply Lava 20 Vertical (200mm wide) over the cracks, cover it with a correctly cut piece of Polyester/



OWL WATERPROOFING SOLUTIONS

Matting and press it into place.

5. Saturate the fabric with enough Lava 20 Vertical until fully covered and allow 12 hours for curing.

Expansion and Control Joints

Ensure the proper sealing of expansion and control joints for an effective waterproofing result.

1. Clean the joints of dust, debris, or contaminants. If needed, cut the joints wider and deeper. The joint should have a depth of 10-15 mm, with a width-to-depth ratio of approximately 2:1.
2. Apply Owl PU Mastic at the base of the joint. Brush a 200mm wide stripe of Lava 20 Vertical inside and over the joint.
3. Insert Polyester/matting into the wet coating, pressing it deep into the joint. Saturate the fabric with more Lava 20 Vertical to cover it fully. Place a polyethylene cord into the joint, pressing it down onto the saturated fabric.
4. Fill the remaining space with Owl PU Mastic and leave the joint uncovered. Allow the joint to cure for 12-18 hours.

Priming

Different Surfaces:

- Highly absorbent surfaces such as concrete, cement screed, or wood should be primed with Lava 20 Fast Primer or Owl Universal 2 Part Epoxy Primer.
- Surfaces like bitumen or asphalt felts should be treated with Owl Universal 2 Part Epoxy Primer.
- Non-absorbent surfaces such as metal, ceramic tiles, or old coatings should be primed using Lava 20 Fast Primer.
- Bitumen asphalt felts and acrylic coatings should be primed with Owl Universal 2 Part Epoxy Primer.
- For TPO, PP, and EPDM surfaces, use Lava 20 EPDM & TPO Primer.
- PVC surfaces should be activated with Lava 20 Cleaner & PVC Primer.

Allow the primer to cure following the specific technical instructions.

Waterproofing Membrane Application

Stir Lava 20 Vertical thoroughly before application. Pour the product onto the primed surface and spread it evenly using a roller, brush, or squeegee. An airless spray can be used to reduce labour effort.

Reinforcement:

1. Always reinforce critical areas like wall-floor junctions, 90° angles, chimneys, pipes, and waterspouts.
2. To do this, apply a cut-to-size piece of polyester/ matting on the still-wet Lava 20 Vertical, press it into the membrane, and then saturate it with another layer of Lava 20 Vertical.
3. For specific reinforcement instructions, contact our technical team. It is recommended to reinforce the entire surface using polyester/matting with 5-10 cm overlapping strips.



OWL WATERPROOFING SOLUTIONS

Additional Layers: After 12-18 hours (but no later than 48 hours), apply another coat of Lava 20 Vertical. For more demanding projects, a third coat may be necessary.

IMPORTANT: The ideal application and curing temperature are between 5°C and 35°C. Lower temperatures will slow curing, while higher temperatures will accelerate it. High humidity may impact the final finish.

For demanding applications

In cases where thicker layers or enhanced aesthetic results are required, it is recommended to add up to 3% Lava 20 Catalyst, depending on temperature and humidity conditions. For applications exceeding 0.900 kg/m² in thickness, the addition of Lava 20 Catalyst is strongly recommended.

Finishing

- If a color-stable and non-chalking surface is desired, apply one or two layers of Lava 20 Coloured Top Coat over Lava 20 Vertical. This top-coat is particularly necessary when a dark final color (e.g., red, grey, green) is preferred.
- For heavy-duty, abrasion-resistant surfaces (e.g., public pedestrian decks, parking lots), apply two layers of Lava 20 Clear Top Coat with quartz. For specific top-coat application procedures, please refer to their technical instructions or contact our technical department.

IMPORTANT: Lava 20 Vertical and/or Lava 20 System can become slippery when wet. To prevent slipperiness on rainy days, sprinkle appropriate aggregates onto the wet coating to create an anti-slip surface. For more details, contact our technical department.

Safety Measures

Lava 20 Vertical contains isocyanates. Please refer to the manufacturer's supplied information and review the Safety Data Sheet. For professional use only.

Our technical guidance, whether verbal or written, is provided in good faith based on the current level of knowledge and experience with our products. However, it is essential that a detailed, case-specific evaluation is conducted to ensure that the product and its application are suitable for your specific requirements. We only guarantee that our products meet their technical specifications; proper application is entirely your responsibility. Users must also adhere to local regulations and obtain any necessary approvals or permits for the product's purchase and/or use. The values provided in this technical data sheet are examples and should not be considered as specifications. For detailed product specifications, please consult our technical department. The latest edition of this data sheet replaces any previous versions, which are no longer valid, so always ensure you have the most up-to-date version at hand.

Note: All values given are typical and not part of the product specification. The sample preparation involved using Lava 20 Catalyst (3%) as an accelerator. Properties may vary depending on film formation quality, which is influenced by factors such as relative humidity, temperature during application, and wet film thickness. The applied coating may yellow or fade when exposed to UV light.



OWL WATERPROOFING SOLUTIONS

LAVA DETAIL 20

Date: 24. 09. 2025 - V. 24
TECHNICAL DATA SHEET

Liquid Polyurethane-Based Fiber-Reinforced Waterproofing Membrane Designed for Complex Roofing Details

Product Description

Lava Detail 20 is a liquid-applied, thixotropic, permanent, elastic, fiber-reinforced, one-component polyurethane coating used for long-lasting waterproofing of complex roofing details and connections.

Product Information

Chemical Base	Single-component, air and ground moisture-cured, cold-applied, and cold-curing thixotropic fiber-reinforced aromatic polyurethane.
UFI	A361-W0GX-F00W-KM90
Packaging	1, 6 kg metal pails
Colour	Grey, Black, White
Shelf Life	9 months from the date of production

Uses

Lava Detail 20 is mainly used to create waterproof seals on difficult and complex roofing details such as: Wall-floor connections, Flashings and 90° angles, Light domes, Roof lights, Chimneys, Pipes, Gutters etc.

Consumption

2 - 3 kg/m² depending on application.

The coverage is based on application by roller onto a smooth surface in optimum conditions. Factors like surface porosity, temperature and application method can alter consumption. In case of, Fabric reinforcement, consumption may alter.

Advantages

- Easy to use (roller or airless spray)
- A flawless, jointless membrane is formed when applied.
- UV stable
- Resistant to raw sewage and frost
- The waterproofed surface can be used for domestic (light) foot traffic.
- Resistant to detergents, oils, seawater, and household chemicals.
- Provides water vapor permeability, allowing the surface to breathe.
- Excellent heat resistance, preventing it from softening.
- Excellent weather resistance
- Excellent adhesion to ceramic tiles, and excellent adherence to glazed surfaces

Surfaces

The primary application for Lava Detail 20 is the construction of waterproof seals between various building materials, such as Bitumen felts, PVC membranes, concrete, mortar, and screed, as well as various metals and wood.



OWL WATERPROOFING SOLUTIONS

Technical Data*

PROPERTY	RESULTS	TEST METHOD
Composition	Polyurethane high-solids pre-polymer	
Elongation at Break	> 250 %	ASTM D 412
Tensile Strength	> 2 N/mm ²	ASTM D 412
Water Vapor Permeability	10 gr/m ² per 24 hours	ISO 9932:91
Resistance to Water Pressure	No Leak (1m water column, 24h)	DIN EN 1928
Carbon Dioxide Permeability (1.2kg/m²)	2.5 gr/m ² /day	EN 1062-6
Water Permeability (1.2kg/m²)	0.025 kg/m ² /h0.5	EN 1062-3
Adhesion to concrete	> 2.5 N/mm ² (concrete failure)	EN 1542
Hardness (Shore A Scale)	65-70	ASTM D 2240
Application Temperature	5° C to 35°C	
Rain Stability Time	3-4 hours	Conditions: 20°C, 50% RH
Light Pedestrian Traffic	12-18 hours	
Final Curing time	7 days	
Chemical Properties	Good resistance against acidic and alcalic solutions (5%), detergents, seawater and oils.	

Certifications

EAD 030350-00-0402: European Technical Approval: ETA22/ 0640

Working life expected:	W3 (4.1kg/m²)	25 Years
Climate Zone:	M and S	All
Imposed loads:	P1 to P4	Very High (maximum load)
Roof slopes:	S1 to S4	<5o to >30o
Lowest surface temperature:	TL4	-30oC
Highest surface temperature:	TH4	+90oC
Reaction to fire:	Class E	EN 13501-1
Resistance to wind loads	≥ 50 kPa	EU Norm
Working life expected:	W2 (2.4kg/m²)	10 Years
Climate Zone:	M and S	All
Imposed loads:	P1 to P3	High
Roof slopes:	S1 to S4	<5o to >30o
Lowest surface temperature:	TL3	-20oC
Highest surface temperature:	TH4	+90oC
Reaction to fire:	Class E	EN 13501-1
Resistance to wind loads	≥ 50 kPa	EU Norm

The synthetic polymer microparticles supplied are subject to conditions laid down by entry 78 of Annex XVII to Regulation (EC) No 1907/2006 of the European Parliament and of the Council.



Applications

Surface Preparation/ Priming

For highly absorbent surfaces such as concrete, cement screed, or wood, use Lava 20 Fast Primer or Lava 20 Epoxy Primer. For non-absorbent surfaces like metal, ceramic tiles, and old coatings, apply Lava 20 Epoxy



OWL WATERPROOFING SOLUTIONS

Primer. Bitumen, asphalt felts, and acrylic coatings should also be primed with Lava 20 Epoxy Primer

Detail Waterproofing membrane

Before using, thoroughly and carefully stir Lava Detail 20 with a wooden staff. Don't use a power drill. Use a 10 cm wide brush to evenly apply the Lava Detail 20 to the prepared and/or primed surface. Apply a second layer 18 to 36 hours later. Always reinforce with chopped strand matting/ polyester tape. Apply a correctly cut piece of chopped strand matting/ polyester tape to the still-wet Lava Detail 20, press it to soak, and then saturate it once more with sufficient Lava Detail 20 to complete the task.

ATTENTION: Avoid using the Lava Detail 20 on surfaces that are below +5°C during application and for 4 hours following, on frozen surfaces, in the rain or mist, on wet Lava Detail 20 Primer, or on surfaces with rising humidity. High temperatures hasten curing while low temperatures delay it.

Finishing

Apply one or two layers of the Lava 20 Top Coat on top of the Lava Detail 20 to create a surface that is color stable and free from chalking. If a dark final color is desired, the application of the Lava 20 Coloured Top-Coat is especially necessary. Alternately, to protect against UV rays and improve the end result optically, suitable aggregate can be broadcast over the final (second) layer of the Lava Detail 20 while it is still wet, until full saturation. Please refer to the various finishing application techniques' technical instructions or get in touch with us.

WARNING: Wet conditions make the Lava Detail 20 and/or Lava 20 System slippery. Sprinkle appropriate aggregates onto the still-wet coating to create an anti-slip surface to prevent slipperiness on rainy days. Please contact our technical dept. for more information.

Packaging

Lava Detail 20 is available in 6 kg pails. Pails should be kept for up to nine months in cool, dry areas. The material needs to be protected from moisture and direct sunshine. Storage range: 5° to 30° C. Items must be kept in their original, unused containers with labels on the application precautions, batch number, manufacturer's name, and product identification.

Safety measures

Lava Detail 20 contains isocyanates. See information supplied by the manufacturer. Please study the Safety Data sheet. **PROFESSIONAL USE ONLY**

Our technical advice for use, whether verbal, written or in tests, is given in good faith and reflect the current level of knowledge and experience with our products. When using our products, a detailed object-related and qualified inspection is required in each individual case in order to determine whether the product and /or application technology in question meets the specific requirements and purposes. We are liable only for our products being free from faults; correct application of our products therefore falls entirely within your scope of liability and responsibility. We will, of course, provide products of consistent quality within the scope of our General Conditions of Sale and Delivery. Users are responsible for complying with local legislation and for obtaining any required approvals or authorizations. Values in this technical data sheet are given as examples and may not be regarded as specifications. The new edition of the technical data sheet supersedes the previous technical information and renders it invalid. It is therefore necessary that you always have to hand the current code of practice. *All values represent typical values and are not part of the product specification.



OWL WATERPROOFING SOLUTIONS

Date: 21. 12. 2022 - V. 22
TECHNICAL DATA SHEET

LAVA 20 CLEAR TOPCOAT

Transparent Liquid Polyurethane Waterproofing Coating

Product Description

Lava 20 Clear Topcoat is a durable, transparent polyurethane waterproofing coating designed to be tough and long-lasting. Its advanced formulation remains transparent and flexible, even after aging, and offers UV stability without yellowing, resistance to weather, alkalis, and chemicals. Lava 20 Clear Topcoat protects and waterproofs natural surfaces from elements such as acid rain, fog, frost, and water. It also enhances the transparency of aged and oxidized plastic surfaces and waterproofs damaged glass. Lava 20 Clear Topcoat serves as a transparent binder resin for sand carpet floor coatings, particularly in exterior applications where UV stability and flexibility are essential. This topcoat uses a specialized curing system (moisture-triggered) that, unlike other systems, does not react with moisture or form bubbles during curing.

Product Information

Chemical Base	Cold-curing, solvent-based, single component aliphatic polyurethane
Packaging	1, 5 kg metal pails
Colour	Transparent
Shelf Life	9 months from the date of production

Main Uses

Waterproofing of:

- Decks and patios
- Wood
- Preservation of Natural Stones
- Porcelain Surfaces
- Glass and Crystal
- Opaque Plastics (like Polyacrylate and Polycarbonate)

Sand carpet outdoor floor sealing applications using adhesive resin.

Advantages

- Easy to apply using a roller or airless spray.
- Creates a seamless, transparent membrane upon application.
- UV-resistant.
- Withstands stagnant water and frost.
- Allows water vapor permeability, enabling the surface to breathe.
- Offers excellent thermal resistance and remains firm without softening.
- Provides outstanding weather resistance.
- Retains its mechanical properties across a temperature range of -40°C to +90°C.
- Adheres well to ceramic tiles and glazed surfaces.
- Suitable for light pedestrian traffic on waterproofed surfaces.
- Resistant to detergents, oils, seawater, and household chemicals.
- Can be quickly and easily repaired locally if damaged.
- Serves as a flexible and elastic binder resin for sand carpet applications, ideal for balconies and terraces.

Consumption

0,800 - 1,200 kg/m² in two or three layers
This coverage is based on application by roller onto a smooth surface in optimum conditions. Factors like surface porosity, temperature and application method can alter consumption.

- Apply 150 to 300 g/m² in one or two layers as a sealing layer for decorative floor flakes.
- For sand carpets, use a ratio of 1:10 as a resin binder, with 1 kg of Lava 20 Clear Topcoat mixed with 10 kg of aggregates.



OWL WATERPROOFING SOLUTIONS

Technical Data*

Property	Results	Test Method
Composition	Polyurethane high-solids pre-polymer	
Elongation at Break	220%	DIN EN ISO 527
Tensile Strength	>20 N/mm ²	DIN EN ISO 527
Gloss retention after 2000h of accelerated ageing (DIN EN ISO 4892-3, 400 MJ/m ²)	Good	DIN 67530
Surface chalking after 2000h of accelerated ageing	No chalking observed. Chalking grade 0	ASTM G154
Hardness (SHORE D Scale)	25	ASTM D 2240
Resistance to Water Pressure	No Leak (1m water column, 24h)	DIN EN 1928
Permeability to CO ₂ (measured in CE system)	0.39g/m ² d	EN 1062-6
Water vapour permeability (measured in CE system)	5.15g/ m ² d	EN ISO 7783
Capillary absorption and permeability to water (measured in CE system)	0.008 kg/ m ² .h ^{0.5}	EN 1062-3
Adhesion to absorbent ceramic tile	>2,0 N/mm ² (ceramic tile failure)	EN 1542
Hydrolysis (5% KOH, 7days cycle)	No significant elastomeric change	Inhouse Lab
Service Temperature	-40° C to +90° C	Inhouse Lab
Tack Free Time	6-8 hours	Conditions: 20 °C, 50% RH
Light Pedestrian Traffic Time	24 hours	
Final Curing time	7 days	
Chemical Properties	Good resistance against detergents, seawater and oils.	

Certifications

EN1504-2: Surface protection for concrete. (0.8kg Lava 20 Clear Top Coat)



Application as a Transparent Waterproofing Coating

Surface Preparation

For the best quality and longevity, careful surface preparation is necessary. The surface must be free of any pollution that could compromise the membrane's adhesion and be clean, dry, and sound. No more than 5% of the total weight should be moisture. At least 28 days must pass before new concrete constructions are ready. It is necessary to remove dust, organic materials, grease, oils, and old coatings. Surface imperfections should be leveled, and all loose particles and dust must be completely cleared. **Avoid using water to clean the surface!**

ATTENTION: Surfaces with trapped moisture (e.g. trapped moisture under tiles) must be left to dry completely



OWL WATERPROOFING SOLUTIONS

(max. 5% moisture), before the application of Lava 20 Clear Top Coat.

WARNING: Avoid applying Lava 20 Clear Topcoat on ceramic surfaces with rising nitric salts in the joints without proper pre-treatment. Do not apply Lava 20 Clear Topcoat on surfaces previously treated with silane, siloxane, silicone, or other water-repellents, as it may result in poor adhesion. If the surface history is unclear, it is recommended to conduct an adhesion test. For marble and granite surfaces, perform an adhesion test to confirm proper bonding.

Repair of cracks and joints

1. Clean the Cracks and Joints:

Remove dust, debris, and any contaminants from concrete cracks, hairline cracks, expansion joints, and control joints to ensure proper adhesion.

2. Prime the Area:

Apply Lava 20 Fast Primer to the cleaned cracks and joints. Allow 2-3 hours for the primer to dry fully.

3. Seal the Cracks and Joints:

Use Owl PU Mastic to fill all the prepared cracks and joints thoroughly. Let the mastic cure completely before proceeding with further waterproofing.

Priming (Surface Activation)

1. Prime Non-Absorbent Surfaces:

For non-absorbent, glazed surfaces such as ceramic tiles, glass, and glass bricks, use Lava 20 Fast Primer for surface activation.

2. Application Method:

Soak a clean, dry cloth with Lava 20 Fast Primer and wipe down the entire surface. This method not only chemically activates (primes) the surface but also effectively removes grease.

Important Notes: Frequently change cloths during the process to maintain efficiency. Ensure the entire surface receives an adequate amount of primer and that no areas are left untreated.

Warning: Do not use Lava 20 Fast Primer on transparent plastics such as polycarbonate or polyacrylate.

Transparent waterproofing membrane

1. Lava 20 Application:

Apply Lava 20 Clear Top Coat over the primed surface using a roller or a trowel with the appropriate teeth to evenly spread it over the entire area. After 12 hours (but no later than 18 hours), apply a second coat of Lava 20 Clear Top Coat using a roller or brush to enhance the waterproofing. For additional waterproofing and increased durability, apply a third coat of Lava 20 Clear Top Coat.

2. Layer Thickness:

Attention: Do not apply layers thicker than 1 mm of dry film to avoid complications during curing.

3. Satin Matte Finish:

If you desire a satin matte surface, apply one layer of Lava 20 Clear Topcoat to achieve the desired look.

4. Temperature Considerations:

The ideal application and curing temperature are between 5°C and 35°C. High temperatures speed up curing, while low temperatures slow it down. Excess humidity may negatively impact the finish, potentially causing surface pinholes or bubbles.

Anti-Slip Precaution: While Lava 20 Clear Top Coat is wet, it can be slippery. To prevent this, sprinkle appropriate aggregates onto the wet coating to create an anti-slip surface, especially useful for rainy days.

Best Practices: For optimal results, aim for an application temperature range between 5°C and 30°C.

Be mindful that high humidity can affect the finish quality, and surface imperfections may appear if not managed properly.



OWL WATERPROOFING SOLUTIONS

Application as a Binder Resin for Sand carpet Coating

Surface Preparation (For Lava 20 Applications):

Ensure the surface is clean, dry, sound, and free from contaminants that could affect the adhesion of the sandcarpet coating. Maximum surface moisture content should be no more than 5%. Smooth out any surface irregularities and remove all loose particles and dust.

Important: Do not wash the surface with water.

For Concrete Applications:

Make sure the concrete surface is clean, dry, and free from contaminants that may impact adhesion. Moisture content should not exceed 5%. Allow new concrete structures to dry for at least 28 days. Remove any old coatings, dirt, oils, or organic matter, and smooth out surface imperfections.

Important: Do not wash the surface with water.

Priming:

Prime the concrete surface with Lava 20 Fast primer. While the primer is still wet, sprinkle quartz/ silica sand over the surface.

Sandcarpet Coating:

Mix Lava 20 Clear Topcoat with colored silica sand (grain size 0.7-1.2 mm or 2.0-3.5 mm) at a ratio of 1:10 (resin to sand by weight). Use a low-speed mechanical mixer to blend the mixture until it is fully homogeneous. Pour the mixture onto the prepared surface and apply it using a flat trowel.

Temperature Considerations: The ideal application and curing temperature are between 5°C and 35°C. Low temperatures will slow the curing process, while high temperatures will accelerate it. High humidity can affect the final finish.

Application as a Sealer Coating for Decorative Flakes Floor System

Sealer Coating:

On the prepared surface (such as epoxy/polyurethane flooring with decorative flakes), apply the first layer of Lava 20 Clear Topcoat using a high-quality, short-hair roller (moher). Apply at a rate of 150-300 g/m². After 12 hours (but no later than 18 hours), apply a second layer of Lava 20 Clear Topcoat, if needed.

Temperature Guidelines: For best results, ensure the temperature during application and curing is between 5°C and 30°C. Low temperatures will slow down curing, while high temperatures will speed it up. High humidity may negatively impact the finish.

Storage Conditions

Lava 20 Clear Top Coat pails should be stored in dry and cool rooms. Protect the material against moisture and direct sunlight. Storage temperature: 5° to 30°C. Products should remain in their original, unopened containers, bearing the manufacturer's name, product designation, batch number and application precaution labels.

Safety measures

Lava 20 Clear Top Coat contains isocyanates. See information supplied by the manufacturer. Please study the Safety Data Sheet. PROFESSIONAL USE ONLY.

Our technical advice for use, whether verbal or written, is given in good faith and reflect the current level of knowledge and experience with our products. When using our products, a detailed object-related and qualified inspection is required in each individual case in order to determine whether the product and /or application technology in question meets the specific requirements and purposes. We may guarantee only that our products are compliant with their technical specification; correct application of our products therefore falls entirely within your scope of liability and Users are responsible, in any case, for complying with local legislation and for obtaining any required approvals or authorizations, when necessary, either for their purchase and/or for their use. Values in this technical data sheet are given as examples and may not be regarded as specifications. The new edition of the technical data sheet supersedes the previous technical information and renders it invalid. It is therefore necessary that you always have to hand the current code of practice.* All values represent typical values and are not part of the product specification.



OWL WATERPROOFING SOLUTIONS

Lava 20 Coloured Top Coat

Date: 24. 11. 2023 - V. 23
TECHNICAL DATA SHEET

(Dark Grey, Coloured, Red, Blue, Green, Light Grey, Yellow, Black, Brown)

UV-resistant Aliphatic Polyurethane Top Coat

Product Description

Lava 20 Coloured Top Coat is a pigmented, colour- and UV-stable, highly elastic polyurethane coating designed as a top-coat for protecting exposed polyurethane waterproofing membranes. It cures through a unique moisture-triggered chemical reaction, using both ground and air moisture. It provides excellent protection, particularly when a dark final color is preferred.

Product Information

Chemical Base	One-component, solvent-based, cold curing aliphatic polyurethane
Packaging	1 kg, 5 kg, 20 kg pails
Colour	Dark Grey, White, Red, Blue, Green, Light Grey, Yellow, Black, Brown
Shelf Life	9 months from date of production

Certifications

EN13813: Screed material and floor screed: 0.3kg/m²



Advantages

- Easy to use (roller or airless spray).
- Improves the waterproofing membrane's resilience to stress and corrosion.
- Offers high solar reflectivity (white), which helps with thermoinsulation.
- Colour and UV resistance.
- Produces a glossy, cleanable surface.
- Does not exhibit the aromatic polyurethane coatings' grainy effect.
- Maintains its mechanical qualities across a temperature range of -40°C to +90°C
- Water, heat, and frost resistant.

Main Uses

- Roof waterproofing
- Roof, Terrace, balcony, and patio waterproofing
- Waterproofing footpaths, walkways, podium decks and auto decks etc.
- Waterproofing flat or sloped roofs, balconies and decks etc

Applied on: Lava 20, Lava 20 Vertical, Lava Detail 20, and similar surfaces with light pedestrian traffic, offering a glossy, colour-stable, and non-chalking finish.

Consumption

0.150 – 0.300 kg/m² in one or two layers.

Its coverage is based on effective roller application onto a flat surface under ideal circumstances. Consumption can be affected by elements like surface porosity, temperature, humidity, application technique, and finish necessary.



OWL WATERPROOFING SOLUTIONS

Technical Data

PROPERTY	RESULTS	TEST METHOD
Elongation at Break	180 %	ASTM D 412
Tensile Strength	> 20 N/ mm ²	ASTM D 412
Resistance to Water Pressure	No Leak	DIN EN 1928
Gloss retention after 2000h of accelerated aging (DIN EN ISO 4892-3, 400 MJ/m ²)	Good	DIN 67530
Gloss chalking after 2000h of accelerated aging (DIN EN ISO 4892-3, 400 MJ/m ²)	No chalking observed. Chalking grade 0	DIN EN ISO 4628-6
Adhesion to Lava 20	>2 N/mm ²	EN 1542
Adhesion to cement	4.5N/mm ²	EN 13892-8
Hardness (Shore A Scale)	85-90	ASTM D 2240 (15'')
Solar Reflectance Index (SRI) (white colour)	107	ASTM E1980-01
Infrared emittance (white colour)	0.89	ASTM C1371-04a
Solar Reflectance (white colour)	85	ASTM E903-12
UV accelerated ageing, in the presence of moisture	Passed - No significant changes	EOTA TR-010
Hydrolysis (5% KOH, 7days cycle)	No significant elastomeric change	Inhouse Lab
Service Temperature	-40°C to +90°C	In-house Lab
Tack Free Time	1-3 hours	
Light Pedestrian Traffic Time	12 hours	Conditions: 20°C, 50% RH
Final Curing time	7 days	
Chemical Properties	Good resistance against acidic and alkali solutions (5%), detergents, seawater and oils.	

Application:

Surface Preparation

Proper surface preparation is crucial for achieving the best finish and long-lasting durability. Follow these steps to ensure the surface is ready for application:

1. Clean and Dry Surface:

Ensure the concrete surface is clean, dry, and structurally sound. Remove any contaminants that could negatively affect the adhesion of the membrane. Maximum moisture content should be below 5%.

2. Structural Requirements:

Substrate compressive strength should be at least 25 MPa. Cohesive bond strength must be at least 1.5 MPa. New concrete structures need to cure for at least 28 days before applying any membrane.

3. Remove Contaminants:

Use a grinding machine to eliminate old coatings, dirt, grease, oils, organic substances, and dust. Smooth out any surface irregularities, and thoroughly remove all loose debris and grinding dust. For substrates other than concrete, consult the technical support team for guidance on surface preparation.

Waterproofing Membrane

Refer to the Product Data Sheet: For specific details on the Lava 20 waterproofing membrane.



OWL WATERPROOFING SOLUTIONS

Top Coat Application Instructions

Stir thoroughly before applying and ensure that the Lava 20 Coloured Top Coat is well stirred for even consistency.

1. Application Method:

Apply Lava 20 Coloured Top Coat using a roller, brush, or airless spray. The coating should be applied in one or two layers.

2. Curing Time:

Allow 3-6 hours between layers, but no more than 36 hours.

3. Optimal Application Temperature:

For best results, apply when the temperature is between 5°C and 35°C. Low temperatures will slow curing, while high temperatures will speed it up. High humidity may affect the finish, so take precautions if necessary.

4. Flake Flooring Systems:

For flake flooring systems, sprinkle the flakes onto the freshly applied Lava 20 Coloured Top Coat.

Safety Warnings

Lava 20 Coloured Top Coat and Lava 20 System can become slippery when wet. To prevent slipperiness during wet conditions, sprinkle appropriate anti-slip aggregates onto the wet coating.

Maintenance for Stagnant Water:

In areas with stagnating water, clean the Lava 20 System regularly to prevent biological or microbial growth. For more information on anti-slip or cleaning recommendations, contact the technical department.

Packaging

Lava 20 Coloured Top Coat is available in metal pails of 1 kg, 5 kg & 20 kg. Pails should be kept for up to nine months in cool, dry areas. The material needs to be protected from moisture and direct sunshine. 5°C to 30°C C for storage. Items must be kept in their original, unopened packaging with labels that clearly state the manufacturer, the product name, the batch number, and any application warnings.

Safety Measures

Lava 20 Coloured Top Coat contains isocyanates. See information supplied by the manufacturer. Please study the Safety Data sheet. PROFESSIONAL USE ONLY

Our technical advice for use, whether verbal or written, is given in good faith and reflects the current level of knowledge and experience with our products. When using our products, a detailed object-related and qualified inspection is required in each case to determine whether the product and /or application technology in question meets the specific requirements and purposes. We may guarantee only that our products are compliant with their technical specification; correct application of our products therefore falls entirely within your scope of liability and Users are responsible, in any case, for complying with local legislation and for obtaining any required approvals or authorizations, when necessary, either for their purchase and/or for their use. Values in this technical data sheet are given as examples and may not be regarded as specifications. The new edition of the technical data sheet supersedes the previous technical information and renders it invalid. It is therefore necessary that you always have to hand in the current code of practice.

* All values represent typical values and are not part of the product specification. **: The applied sealant might yellow and/or fade upon UV exposure.



LAVA 20 FAST PRIMER

Safety Data Sheet

According to Regulation (EC) No. 1907/2006 (REACH) with its Amendment Regulation (EC) No. 1272/2008 (CLP) and EU 2020/878

Printing Date 12. 10. 2021

Version Number 5 (replaces version 4)

Revision: 12. 10. 2021

SECTION 1: Identification of the substance/mixture and of the company/undertaking

1.1 Product identifier

Trade name: LAVA 20 FAST PRIMER

1.2 Relevant identified uses of the substance or mixture and uses advised against Professional use

Application of the substance / the mixture: Polyurethane primer

1.3 Details of the supplier of the safety data sheet

Manufacturer/Supplier:

OWL WATERPROOFING SOLUTIONS

135 Slaney Road, Dublin Industrial Estate

Glasnevin, Dublin 11

Tel: +353 01 830 2250

Email: info@owlwaterproofing.co.uk

Website: www.owlwaterproofing.co.uk

1.4 Emergency telephone number:

European Emergency Tel.: +353 01 830 2250

SECTION 2: Hazards identification

2.1 Classification of the substance or mixture

Classification according to Regulation EC No 1272/2008 CLP:

GHS02 flame



Flam. Liq. 3 H226 Flammable liquid and vapour.

GHS08 health hazard



Resp. Sens. 1 H334 May cause allergy or asthma symptoms or breathing difficulties if inhaled.

Carc. 2 H351 Suspected of causing cancer.

STOT RE 2 H373 May cause damage to organs through prolonged or repeated exposure.

Asp. Tox. 1 H304 May be fatal if swallowed and enters airways.

GHS07



Acute Tox. 4 H332 Harmful if inhaled.

Skin Irrit. 2 H315 Causes skin irritation.

Eye Irrit. 2 H319 Causes serious eye irritation.

Skin Sens. 1 H317 May cause an allergic skin reaction.

STOT SE 3 H335 May cause respiratory irritation.

Aquatic Chronic 3 H412 Harmful to aquatic life with long lasting effects.



LAVA 20 FAST PRIMER

Safety Data Sheet

According to Regulation (EC) No. 1907/2006 (REACH) with its Amendment Regulation (EC) No. 1272/2008 (CLP) and EU 2020/878

Printing Date 12. 10. 2021

Version Number 5 (replaces version 4)

Revision: 12. 10. 2021

2.2 Label elements

Labelling according to Regulation EC No 1272/2008 CLP:

The product is classified and labelled according to the CLP regulation.

Hazard pictograms:



GHS02 GHS07 GHS08

Signal word: Danger

Hazard-determining components of labelling:

Reaction mass of ethylbenzene and m-xylene and p-xylene
diphenylmethane diisocyanate, isomers and homologues
maleic anhydride
m-tolylidene diisocyanate

Addition reaction products of conjugated sunflower-oil fatty acids and tall-oil fatty acids with maleic anhydride

Hazard statements:

H226 Flammable liquid and vapour.

H332 Harmful if inhaled.

H315 Causes skin irritation.

H319 Causes serious eye irritation.

H334 May cause allergy or asthma symptoms or breathing difficulties if inhaled.

H317 May cause an allergic skin reaction.

H351 Suspected of causing cancer.

H335 May cause respiratory irritation.

H373 May cause damage to organs through prolonged or repeated exposure.

H304 May be fatal if swallowed and enters airways.

H412 Harmful to aquatic life with long lasting effects.

Precautionary statements

P201 Obtain special instructions before use.

P210 Keep away from heat, hot surfaces, sparks, open flames and other ignition sources. No smoking.

P260 Do not breathe dust/fume/gas/mist/vapours/spray.

P273 Avoid release to the environment.

P280 Wear protective gloves/protective clothing/eye protection/face protection/hearing protection.

P301+P310 IF SWALLOWED: Immediately call a POISON CENTER/ doctor.

P331 Do NOT induce vomiting.

P302+P352 IF ON SKIN: Wash with plenty of water and soap.

P304+P340 IF INHALED: Remove person to fresh air and keep comfortable for breathing.

P305+P351+P338 IF IN EYES: Rinse cautiously with water for several minutes. Remove contact lenses, if present and easy to do. Continue rinsing.



LAVA 20 FAST PRIMER

Safety Data Sheet

According to Regulation (EC) No. 1907/2006 (REACH) with its Amendment Regulation (EC) No. 1272/2008 (CLP) and EU 2020/878

Printing Date 12. 10. 2021

Version Number 5 (replaces version 4)

Revision: 12. 10. 2021

P308+P313 IF exposed or concerned: Get medical advice/attention.

P403+P235 Store in a well-ventilated place. Keep cool.

P501 Dispose of contents/container in accordance with local/regional/national/international regulations.

Additional information:

EUH204 Contains isocyanates. May produce an allergic reaction.

2.3 Other hazards

Results of PBT and vPvB assessment

PBT: Not applicable.

vPvB: Not applicable.

SECTION 3: Composition/information on ingredients

3.2 Mixtures

Description: Mixture: consisting of the following components.

Ingredients according to Regulation (EU) 2020/878:

EC number: 905-562-9 Reg. nr: 01-2119488216-32-XXXX	Reaction mass of ethylbenzene and m-xylene and p-xylene Flam. Liq. 3, H226; STOT RE 2, H373; Asp. Tox. 1, H304; Acute Tox.4, H312; Acute Tox. 4, H332; Skin Irrit. 2, H315; Eye Irrit. 2, H319; STOT SE 3, H335; Aquatic Chronic 3, H412	25-50%
CAS: 9016-87-9	Diphenylmethane diisocyanate, isomers and homologues Resp. Sens. 1, H334; Carc. 2, H351; STOT RE 2, H373; Acute Tox. 4, H332; Skin Irrit. 2, H315; Eye Irrit. 2, H319; Skin Sens. 1, H317; STOT SE 3, H335, EUH204 Specific concentration limits: Eye Irrit. 2; H319: C ≥ 5 % Skin Irrit. 2; H315: C ≥ 5 % Resp. Sens. 1; H334: C ≥ 0.1 % STOT SE 3; H335: C ≥ 5 %	10-25%
CAS: 108-65-6 EINECS: 203-603-9 Index number: 607-195-00-7 Reg.nr.: 01-2119475791-29-XXXX	2-methoxy-1-methylethyl acetate Flam. Liq. 3, H226	10-25%



LAVA 20 FAST PRIMER

Safety Data Sheet

According to Regulation (EC) No. 1907/2006 (REACH) with its Amendment Regulation (EC) No. 1272/2008 (CLP) and EU 2020/878

Printing Date 12. 10. 2021

Version Number 5 (replaces version 4)

Revision: 12. 10. 2021

CAS: 26471-62-5 EINECS: 247-722-4 Index number: 615-006-00-4 Reg.nr.: 01-2119454791-34-XXXX	m-tolylidene diisocyanate Acute Tox. 2, H330; Resp. Sens. 1, H334; Carc. 2, H351; Skin Irrit. 2, H315; Eye Irrit. 2, H319; Skin Sens. 1, H317; STOT SE 3, H335; Aquatic Chronic 3, H412, EUH204 Specific concentration limit: Resp. Sens. 1; H334: C \geq 0.1 %	≥ 0.1 -<1%
EC number: 701-043-4 Reg.nr.: 01-2119976378-19-XXXX	Addition reaction products of conjugated sunflower-oil fatty acids and tall-oil fatty acids with maleic anhydride Skin Irrit. 2, H315; Skin Sens. 1, H317	≥ 0.1 -<1%
CAS: 108-31-6 EINECS: 203-571-6 Index number: 607-096-00-9 Reg.nr.: 01-2119472428-31-XXXX	maleic anhydride Resp. Sens. 1, H334; STOT RE 1, H372; Skin Corr. 1B, H314; Acute Tox. 4, H302; Skin Sens. 1, H317 Specific concentration limit: Skin Sens. 1A; H317: C \geq 0.001 %	≥ 0.001 -<0.1%

SECTION 4: First aid measures

4.1 Description of first aid measures

General information:

After inhalation:

Remove to open air.

If the subject stops breathing, administer artificial respiration.

Get medical advice/attention immediately.

After skin contact:

Remove contaminated clothing.

Rinse skin with a shower immediately.

Get medical advice/attention immediately.

Wash contaminated clothing before using it again.

After eye contact:

Remove contact lenses, if present.

Wash immediately with plenty of water for at least 15 minutes, opening the eyelids fully.

If problem persists, seek medical advice.

Avoid forceful water jets to prevent corneal injury; consult a doctor.



LAVA 20 FAST PRIMER

Safety Data Sheet

According to Regulation (EC) No. 1907/2006 (REACH) with its Amendment Regulation (EC) No. 1272/2008 (CLP) and EU 2020/878

Printing Date 12. 10. 2021

Version Number 5 (replaces version 4)

Revision: 12. 10. 2021

After swallowing:

Get medical advice/attention immediately.

Do not induce vomiting.

Do not administer anything not explicitly authorised by a doctor.

4.2 Most important symptoms and effects, both acute and delayed

No further relevant information available.

4.3 Indication of any immediate medical attention and special treatment needed

No further relevant information available.

SECTION 5: Firefighting measures

5.1 Extinguishing media

Suitable extinguishing agents: CO₂, powder or water spray. Fight larger fires with water spray.

For safety reasons unsuitable extinguishing agents: Water with full jet

5.2 Special hazards arising from the substance or mixture

No further relevant information available.

5.3 Advice for firefighters

Protective equipment:

Mouth respiratory protective device.

Wear fully protective suit.

Additional information

Collect contaminated fire fighting water separately. It must not enter the sewage system.

SECTION 6: Accidental release measures

6.1 Personal precautions, protective equipment and emergency procedures:

Keep away from ignition sources.

Avoid inhalation of vapors.

Wear protective clothing.

Avoid contact with the skin, eyes and clothing.

6.1.1 For non-emergency personnel

Ensure sufficient ventilation.

6.1.2 For emergency responders

Wear protective equipment. Keep unprotected persons away.

First-aid responders must wear protective clothing, gloves, goggles and respiratory device with filter type A.

6.2 Environmental precautions:

Do not allow to enter sewers/ surface or ground water.

6.3 Methods and material for containment and cleaning up:

Collect with absorbent material (sand, diatomite).

Ensure adequate ventilation.

6.4 Reference to other sections:

See Section 7 for information on safe handling.

See Section 8 for information on personal protection equipment.

See Section 13 for disposal information.



LAVA 20 FAST PRIMER

Safety Data Sheet

According to Regulation (EC) No. 1907/2006 (REACH) with its Amendment Regulation (EC) No. 1272/2008 (CLP) and EU 2020/878

Printing Date 12. 10. 2021

Version Number 5 (replaces version 4)

Revision: 12. 10. 2021

SECTION 7: Handling and storage

7.1 Precautions for safe handling Ensure good ventilation/exhaustion at the workplace.

Information about fire - and explosion protection:

Keep ignition sources away - Do not smoke.

Protect against electrostatic charges.

Keep away from heat, sparks, open flames and hot surfaces.



7.2 Conditions for safe storage, including any incompatibilities

Storage:

Requirements to be met by storerooms and receptacles:

Store in a cool location.

Store away from sources of ignition

Provide ventilation for receptacles.

Further information about storage conditions: Keep container tightly sealed.

7.3 Specific end use(s) No further relevant information available.

SECTION 8: Exposure controls/personal protection

8.1 Control parameters

Ingredients with limit values that require monitoring at the workplace:

CAS: 9016-87-9 diphenylmethane diisocyanate, isomeres and homologues

WEL (Great Britain)	Short term value: 0.07 mg/m ³ Long term value: 0.02 mg/m ³ Sen; as - NCO
---------------------	--

CAS: 108-65-6 2-methoxy-1-methylethyl acetate

WEL (Great Britain)	Short term value: 548 mg/m ³ , 100 ppm Long term value: 0.02 mg/m ³ Sen; as - NCO
IOELV (EU)	Short term value: 550 mg/m ³ , 100 ppm Long term value: 275 mg/m ³ , 50 ppm

CAS: 26471-62-5 m-tolyldiene diisocyanate

WEL (Great Britain)	Short term value: 0.07 mg/m ³ Long term value: 0.02 mg/m ³ Sen; as - NCO
---------------------	--



LAVA 20 FAST PRIMER

Safety Data Sheet

According to Regulation (EC) No. 1907/2006 (REACH) with its Amendment Regulation (EC) No. 1272/2008 (CLP) and EU 2020/878

Printing Date 12. 10. 2021

Version Number 5 (replaces version 4)

Revision: 12. 10. 2021

CAS: 108-31-6 maleic anhydride

WEL (Great Britain)	Short term value: 3 mg/m ³ Long term value: 1 mg/m ³ Sen
---------------------	--

DNELs

ETHYLBENZOLE REACTION MIXTURE, m-Xylol and p-Xylol.

DNEL Workers:

Inhalation - Intensive systemic effect = 289 mg / m³

Inhalation - Chronic systemic effect = 77 mg / m³

Skin - Chronic systemic effect = 180 mg / kg

DNEL Consumers:

Mouth - Chronic systemic effect = 1.6 mg / kg

Inhalation - Intensive systemic effect = 174 mg / m³

Inhalation - Chronic systemic effect = 14.8 mg / m³

Skin - Chronic systemic effect = 108 mg / kg

PNECs

ETHYLBENZOLE REACTION MIXTURE, m-Xylol and p-Xylol.

PNEC:

in fresh water 0.327 mg / l

in marine water 0,327 mg / l

for sediment in fresh water 12,46 mg / kg

for sediment in marinewater 12,46 mg / kg

for water, intermittent release of 0.327 mg / l

for STP 6.58 mg / l microorganisms

for the terrestrial area of 2,31 mg / kg

8.2 Exposure controls

Individual protection measures, such as personal protective equipment

General protective and hygienic measures:

Keep away from foodstuffs, beverages and feed.

Wash hands before breaks and at the end of work.

Do not eat, drink or smoke while using the product.

Do not breathe vapours or mists.

Avoid contact with the eyes and skin.

Respiratory protection:



Use suitable respiratory protective device in case of insufficient ventilation. Respiratory protection required in insufficiently ventilated working areas and during spraying. An air-fed mask, or for short



LAVA 20 FAST PRIMER

Safety Data Sheet

According to Regulation (EC) No. 1907/2006 (REACH) with its Amendment Regulation (EC) No. 1272/2008 (CLP) and EU 2020/878

Printing Date 12. 10. 2021

Version Number 5 (replaces version 4)

Revision: 12. 10. 2021

periods of work, a combination of charcoal filter and particulate filter A2-P2 (EN529) is recommended.

Hand protection



Protective gloves resistant to chemicals (standard EN 374-1)

Due to missing tests no recommendation to the glove material can be given for the product/ the preparation/ the chemical mixture.

The glove material has to be impermeable and resistant to the product/ the substance/ the preparation.

Selection of the glove material on consideration of the penetration times, rates of diffusion and the degradation

Material of gloves

Hand protection when handling the product at room temperature:

Butyl rubber - IIR: thickness $\geq 0,5\text{mm}$; breakthrough time $\geq 480\text{min}$.

Fluorinated rubber - FKM: thickness $\geq 0,4\text{mm}$; breakthrough time $\geq 480\text{min}$.

Recommendation: contaminated gloves should be disposed of.

The selection of the suitable gloves does not only depend on the material, but also on further marks of quality and varies from manufacturer to manufacturer. As the product is a mixture of several substances, the resistance of the glove material can not be calculated in advance and has therefore to be checked prior to the application.

Penetration time of glove material

The determined penetration times according to EN 16523-1:2015 are not performed under practical conditions. Therefore a maximum wearing time, which corresponds to 50% of the penetration time, is recommended.

Eye/face protection



Safety glasses with side-shields (frame goggles) (e.g. EN 166)

Body protection:



Chemically resistant, protective work clothing (EN 14605) and boots.



LAVA 20 FAST PRIMER

Safety Data Sheet

According to Regulation (EC) No. 1907/2006 (REACH) with its Amendment Regulation (EC) No. 1272/2008 (CLP) and EU 2020/878

Printing Date 12. 10. 2021

Version Number 5 (replaces version 4)

Revision: 12. 10. 2021

SECTION 9: Physical and chemical properties

9.1 Information on basic physical and chemical properties

General Information

Physical state	Liquid
Colour: transparent/yellowish	transparent/yellowish
Odour	Characteristic
Odour threshold	Not determined
Melting point/freezing point	Not determined
Boiling point or initial boiling point and boiling range	130 °C
Flammability	Not applicable
Lower and upper explosion limit Lower: Upper: Flash point:	0.8 Vol % 10.8 Vol % 27-32 °C (Reaction mass of ethylbenzene and m-xylene and p-xylene)
Auto-ignition temperature	Product is not selfigniting.
Decomposition temperature	Not determined
Viscosity: Kinematic viscosity Kinematic viscosity Dynamic at 20 °C	Not determined <40 mPas



LAVA 20 FAST PRIMER

Safety Data Sheet

According to Regulation (EC) No. 1907/2006 (REACH) with its Amendment Regulation (EC) No. 1272/2008 (CLP) and EU 2020/878

Printing Date 12. 10. 2021

Version Number 5 (replaces version 4)

Revision: 12. 10. 2021

Solubility water:	Not miscible
Partition coefficient n-octanol/water (log value)	Not determined
Vapour pressure	Not determined
Density and/or relative density Density at 20 °C: Relative density Vapour density	1 g/cm ³ Not determined Not determined
9.2 Other information	VOC(g/l): 498
Appearance: Form:	Liquid
Important information on protection of health and environment, and on safety	
Auto-ignition temperature:	488 °C
Explosive properties:	Product is not explosive. However, formation of explosive air/vapour mixtures are possible.
Solvent content: VOC (EC)	498 g/l
Cloud point / clarification point: Oxidising properties	Not considered as oxidising.



LAVA 20 FAST PRIMER

Safety Data Sheet

According to Regulation (EC) No. 1907/2006 (REACH) with its Amendment Regulation (EC) No. 1272/2008 (CLP) and EU 2020/878

Printing Date 12. 10. 2021

Version Number 5 (replaces version 4)

Revision: 12. 10. 2021

Evaporation rate	Not determined
Information with regard to physical hazard classes	
Explosives	Void
Flammable gases	Void
Aerosols	Void
Oxidising gases	Void
Gases under pressure	Void
Flammable liquids	Flammable liquid and vapour.
Flammable solids	Void
Self-reactive substances and mixtures	Void
Pyrophoric liquids	Void
Pyrophoric solids	Void
Self-heating substances and mixtures	Void
Substances and mixtures, which emit flammable gases in contact with water	Void
Oxidising liquids	Void
Oxidising solids	Void



LAVA 20 FAST PRIMER

Safety Data Sheet

According to Regulation (EC) No. 1907/2006 (REACH) with its Amendment Regulation (EC) No. 1272/2008 (CLP) and EU 2020/878

Printing Date 12. 10. 2021

Version Number 5 (replaces version 4)

Revision: 12. 10. 2021

Organic peroxides	Void
Corrosive to metals	Void
Desensitised explosives	Void

SECTION 10: Stability and reactivity

10.1 Reactivity No further relevant information available.

10.2 Chemical stability

Thermal decomposition / conditions to be avoided Stable at environment temperature.

10.3 Possibility of hazardous reactions No dangerous reactions known.

10.4 Conditions to avoid Avoid heat, sparkles, naked flame or other sources of ignition.

10.5 Incompatible materials No further relevant information available.

10.6 Hazardous decomposition products No dangerous decomposition products known.

SECTION 11: Toxicological information

11.1 Information on hazard classes as defined in Regulation (EC) No 1272/2008

Acute toxicity Harmful if inhaled.

LD/LC50 values relevant for classification:

Inhalative	ATEmix (vapours)	17.7 mg/l (rat)
------------	------------------	-----------------

Reaction mass of ethylbenzene and m-xylene and p-xylene

Oral	LD50	4,300 mg/kg (rat)
Inhalative	LC50 (4h)	5,000 ppm (rat) 5,000 ppm (rabbit)

CAS: 9016-87-9 diphenylmethane diisocyanate, isomeres and homologues

Oral	LD50	>10,000 mg/kg (rat)
Dermal	LD50	>10,000 mg/kg (rabbit)
Inhalative	LC50/4 h (vapour)	0.493 mg/l (rat) (OECD 401) 0.493 mg/l (rabbit)



LAVA 20 FAST PRIMER

Safety Data Sheet

According to Regulation (EC) No. 1907/2006 (REACH) with its Amendment Regulation (EC) No. 1272/2008 (CLP) and EU 2020/878

Printing Date 12. 10. 2021

Version Number 5 (replaces version 4)

Revision: 12. 10. 2021

CAS: 108-65-6 2-methoxy-1-methylethyl acetate

Oral	LD50	>5,000 mg/kg (rat)
Dermal	LD50	>5,000 mg/kg (rat)
Inhalative	LC50 (4 h)	1,805.05 ppm (rat)

CAS: 1330-20-7 Xylene mixture of isomers

Oral	LD50	4,300 mg/kg (rat)
Dermal	LD50	1,700 mg/kg (rabbit)
Inhalative	LC50 (4 h)	5,000 ppm (rat)

CAS: 26471-62-5 m-tolylidene diisocyanate

Oral	LD50	4,130 mg/kg (rat)
Dermal	LD50	>9,400 mg/kg (rabbit)

CAS: 108-31-6 maleic anhydride

Oral	LD50	400 mg/kg (rat)
Dermal	LD50	2,620 mg/kg (rabbit)

Skin corrosion/irritation Causes skin irritation.

Serious eye damage/irritation Causes serious eye irritation.

Respiratory or skin sensitisation

May cause allergy or asthma symptoms or breathing difficulties if inhaled.

May cause an allergic skin reaction.

Germ cell mutagenicity Based on available data, the classification criteria are not met.

Carcinogenicity



LAVA 20 FAST PRIMER

Safety Data Sheet

According to Regulation (EC) No. 1907/2006 (REACH) with its Amendment Regulation (EC) No. 1272/2008 (CLP) and EU 2020/878

Printing Date 12. 10. 2021

Version Number 5 (replaces version 4)

Revision: 12. 10. 2021

Carcinogen, Category 2

Suspected of causing cancer.

Reproductive toxicity Based on available data, the classification criteria are not met.

STOT-single exposure

The product is classified as Specific Target Organ Toxicity after single exposure Category 3

May cause respiratory irritation.

STOT-repeated exposure

STOT Repeated Exposure Category 2

May cause damage to organs through prolonged or repeated exposure.

Aspiration hazard

The product is classified Aspiration toxicity Category 1

May be fatal if swallowed and enters airways.

Additional toxicological information:

Sensitisation Sensitization possible through skin contact

CMR effects (carcinogenicity, mutagenicity and toxicity for reproduction)

CAS: 108-65-6 2-methoxy-1-methylethyl acetate

NOEC (28d)	1.659 mg/l (crustacean)
------------	-------------------------

Carc. 2

11.2 Information on other hazards

Endocrine disrupting properties

None of the ingredients is listed.

SECTION 12: Ecological information

12.1 Toxicity

Aquatic toxicity:

CAS: 108-65-6 2-methoxy-1-methylethyl acetate

EC50 (48h)	8.8 mg/l (crustacean)
LC50 (96h)	6.83 mg/l (fis)



LAVA 20 FAST PRIMER

Safety Data Sheet

According to Regulation (EC) No. 1907/2006 (REACH) with its Amendment Regulation (EC) No. 1272/2008 (CLP) and EU 2020/878

Printing Date 12. 10. 2021

Version Number 5 (replaces version 4)

Revision: 12. 10. 2021

CAS: 1330-20-7 Xylene mixture of isomers

EC50 (48h)	>7.4 mg/l (daphnia magna)
LC50 (96h)	2.6 mg/l (fis)
NOEC r (72h)	440 mg/l (algae)

CAS: 26471-62-5 m-tolyldene diisocyanate

EC50 (48h)	12.5 mg/l (daphnia magna)
LC50 (96h)	133 mg/l (Oncorhynchus mykiss)

12.2 Persistence and degradability No further relevant information available.

12.3 Bioaccumulative potential No further relevant information available.

12.4 Mobility in soil No further relevant information available.

12.5 Results of PBT and vPvB assessment

PBT: Not applicable.

vPvB: Not applicable.

12.6 Endocrine disrupting properties For information on endocrine disrupting properties see section 11.

12.7 Other adverse effects

Remark: Harmful to fish

Additional ecological information:

General notes:

The product contains materials that are harmful to the environment.

Harmful to aquatic organisms

SECTION 13: Disposal considerations

13.1 Waste treatment methods

Recommendation



Dispose according to National Regulations.



Must not be disposed together with household garbage. Do not allow product to reach sewage system.



LAVA 20 FAST PRIMER

Safety Data Sheet

According to Regulation (EC) No. 1907/2006 (REACH) with its Amendment Regulation (EC) No. 1272/2008 (CLP) and EU 2020/878

Printing Date 12. 10. 2021

Version Number 5 (replaces version 4)

Revision: 12. 10. 2021

Contact manufacturer for recycling information.

Uncleaned packaging:

Recommendation:

Disposal must be made according to official regulations.

Packaging may be reused or recycled after cleaning.

SECTION 14: Transport information

14.1 UN number or ID number ADR, IMDG, IATA	UN1866
14.2 UN proper shipping name ADR IMDG, IATA	1866 RESIN SOLUTION RESIN SOLUTION
14.3 Transport hazard class(es) ADR, IMDG, IATA  Class Label	3 Flammable liquids 3
14.4 Packing group ADR, IMDG, IATA	III
14.5 Environmental hazards: Marine pollutant:	No
14.6 Special precautions for user Hazard identification number (Kemler code): EMS Number: Stowage Category	Warning: Flammable liquids 30 F-E,S-E A



LAVA 20 FAST PRIMER

Safety Data Sheet

According to Regulation (EC) No. 1907/2006 (REACH) with its Amendment Regulation (EC) No. 1272/2008 (CLP) and EU 2020/878

Printing Date 12. 10. 2021

Version Number 5 (replaces version 4)

Revision: 12. 10. 2021

14.7 Maritime transport in bulk according to IMO instruments	Not applicable
--	----------------

Transport/Additional information:

ADR Limited quantities (LQ) Excepted quantities (EQ)	5L Code: E1 Maximum net quantity per inner packaging: 30 ml Maximum net quantity per outer packaging: 1000 ml
Transport category Tunnel restriction code	3 D/E
IMDG Limited quantities (LQ) Excepted quantities (EQ)	5L Code: E1 Maximum net quantity per inner packaging: 30 ml Maximum net quantity per outer packaging: 1000 ml
UN "Model Regulation":	UN 1866 RESIN SOLUTION, 3, III

SECTION 15: Regulatory information

5.1 Safety, health and environmental regulations/legislation specific for the substance or mixture

Directive 94/62/EC on packaging and packaging waste.

REACH Regulation 1907/2006/EC

Regulation (EU) 2020/878

CLP Regulation 1272/2008/EC

Directive 98/24/EC on the protection of health and safety of workers from the risks related to chemical agents at work.

Council Directive 94/33/EC on the protection of young people at work, as amended.

Directive 92/85/EEC on the introduction of measures to encourage improvements in the safety and health at work of pregnant workers and workers who have recently given birth or are breastfeeding, as amended



LAVA 20 FAST PRIMER

Safety Data Sheet

According to Regulation (EC) No. 1907/2006 (REACH) with its Amendment Regulation (EC) No. 1272/2008 (CLP) and EU 2020/878

Printing Date 12. 10. 2021

Version Number 5 (replaces version 4)

Revision: 12. 10. 2021

Directive 2012/18/EU

Named dangerous substances - ANNEX I Substance is not listed.

Seveso category P5c FLAMMABLE LIQUIDS

Qualifying quantity (tonnes) for the application of lower-tier requirements 5.000 t

Qualifying quantity (tonnes) for the application of upper-tier requirements 50.000 t

REGULATION (EC) No 1907/2006 ANNEX XVII Conditions of restriction: 3, 74

National regulations:

Other regulations, limitations and prohibitive regulations

Substances of very high concern (SVHC) according to REACH, Article 57

It doesn't contain substances of very high concern (SVHC).

15.2 Chemical safety assessment: A Chemical Safety Assessment has not been carried out.

SECTION 16: Other information

This information is based on our present knowledge. However, this shall not constitute a guarantee for any specific product features and shall not establish a legally valid contractual relationship.

Relevant phrases

H226 Flammable liquid and vapour.

H302 Harmful if swallowed.

H304 May be fatal if swallowed and enters airways.

H312 Harmful in contact with skin.

H314 Causes severe skin burns and eye damage.

H315 Causes skin irritation.

H317 May cause an allergic skin reaction.

H319 Causes serious eye irritation.

H330 Fatal if inhaled.

H332 Harmful if inhaled.

H334 May cause allergy or asthma symptoms or breathing difficulties if inhaled.

H335 May cause respiratory irritation.

H351 Suspected of causing cancer.

H372 Causes damage to organs through prolonged or repeated exposure.

H373 May cause damage to organs through prolonged or repeated exposure.

H412 Harmful to aquatic life with long lasting effects.

EUH204 Contains isocyanates. May produce an allergic reaction.

Department issuing SDS:



OWL WATERPROOFING SOLUTIONS

135 Slaney Road, Dublin Industrial Estate

Glasnevin, Dublin 11

Tel: +353 01 830 2250

Email: info@owlwaterproofing.co.uk

Website: www.owlwaterproofing.co.uk



LAVA 20 FAST PRIMER

Safety Data Sheet

According to Regulation (EC) No. 1907/2006 (REACH) with its
Amendment Regulation (EC) No. 1272/2008 (CLP) and EU 2020/878

Printing Date 12. 10. 2021

Version Number 5 (replaces version 4)

Revision: 12. 10. 2021

Version number of previous version: 4

Abbreviations and acronyms:

ADR: Accord relatif au transport international des marchandises dangereuses par route (European Agreement Concerning the International Carriage of Dangerous Goods by Road)

IMDG: International Maritime Code for Dangerous Goods

IATA: International Air Transport Association

GHS: Globally Harmonised System of Classification and Labelling of Chemicals

EINECS: European Inventory of Existing Commercial Chemical Substances

ELINCS: European List of Notified Chemical Substances

CAS: Chemical Abstracts Service (division of the American Chemical Society)

VOC: Volatile Organic Compounds (USA, EU)

DNEL: Derived No-Effect Level (REACH)

PNEC: Predicted No-Effect Concentration (REACH)

LC50: Lethal concentration, 50 percent

LD50: Lethal dose, 50 percent

PBT: Persistent, Bioaccumulative and Toxic

SVHC: Substances of Very High Concern

vPvB: very Persistent and very Bioaccumulative

Flam. Liq. 3: Flammable liquids – Category 3

Acute Tox. 4: Acute toxicity – Category 4

Acute Tox. 2: Acute toxicity – Category 2

Skin Corr. 1B: Skin corrosion/irritation – Category 1B

Skin Irrit. 2: Skin corrosion/irritation – Category 2

Eye Irrit. 2: Serious eye damage/eye irritation – Category 2

Resp. Sens. 1: Respiratory sensitisation – Category 1

Skin Sens. 1: Skin sensitisation – Category 1

Carc. 2: Carcinogenicity – Category 2

STOT SE 3: Specific target organ toxicity (single exposure) – Category 3

STOT RE 1: Specific target organ toxicity (repeated exposure) – Category 1

STOT RE 2: Specific target organ toxicity (repeated exposure) – Category 2

Asp. Tox. 1: Aspiration hazard – Category 1

Aquatic Chronic 3: Hazardous to the aquatic environment - long-term aquatic hazard – Category 3

*** Data compared to the previous version altered.**



LAVA 20 CLEANER & PVC PRIMER

Safety Data Sheet

According to Regulation (EC) No. 1907/2006 (REACH) with its Amendment Regulation (EC) No. 1272/2008 (CLP) and EU 2020/878

Printing Date 15. 12. 2023

Version Number 4 (replaces version 3)

Revision: 15. 12. 2023

SECTION 1: Identification of the substance/mixture and of the company/undertaking

1.1 Product identifier

Trade name: LAVA 20 CLEANER & PVC PRIMER

Chemical Identification: butanone, methyl ethyl ketone, (MEK).

1.2 Relevant identified uses of the substance or mixture and uses advised against Professional use

Application of the substance / the mixture: Solvent

1.3 Details of the supplier of the safety data sheet

Manufacturer/Supplier:

OWL WATERPROOFING SOLUTIONS

135 Slaney Road, Dublin Industrial Estate

Glasnevin, Dublin 11

Tel: +353 01 830 2250

Email: info@owlwaterproofing.co.uk

Website: www.owlwaterproofing.co.uk

1.4 Emergency telephone number:

European Emergency Tel.: +353 01 830 2250

SECTION 2: Hazards identification

2.1 Substance or Mixture Classification

Classification as per Regulation (EC) No 1272/2008 (CLP):

GHS02 flame

Flam. Liq. 2 H225 Highly flammable liquid and vapour.

GHS07

Eye Irrit. 2 H319 Causes serious eye irritation.

STOT SE 3 H336 May cause drowsiness or dizziness.

2.2 Label Elements

Labelling in Accordance with Regulation (EC) No 1272/2008 (CLP): This product is classified and labelled in compliance with the CLP regulation.

Hazard pictograms:



GHS02

GHS07



LAVA 20 CLEANER & PVC PRIMER

Safety Data Sheet

According to Regulation (EC) No. 1907/2006 (REACH) with its Amendment Regulation (EC) No. 1272/2008 (CLP) and EU 2020/878

Printing Date 15. 12. 2023

Version Number 4 (replaces version 3)

Revision: 15. 12. 2023

Signal word: Danger

Hazard-determining components of labelling: butanone

Hazard statements:

H225 Highly flammable liquid and vapour.

H319 Causes serious eye irritation.

H336 May cause drowsiness or dizziness.

Precautionary statements

P210 Keep away from heat, hot surfaces, sparks, open flames and other ignition sources. No smoking.

P280 Wear protective gloves/protective clothing/eye protection/face protection/hearing protection.

P304+P340 IF INHALED: Remove person to fresh air and keep comfortable for breathing.

P305+P351+P338 IF IN EYES: Rinse cautiously with water for several minutes. Remove contact lenses, if present and easy to do. Continue rinsing.

P403+P235 Store in a well-ventilated place. Keep cool.

P501 Dispose of contents/container in accordance with local/regional/national/international regulations.

Additional information:

EUH066 Repeated exposure may cause skin dryness or cracking.

2.3 Other Hazards

PBT and vPvB Assessment:

The substance does not meet the screening criteria for persistence, bioaccumulation, and toxicity, and therefore, is not classified as PBT (Persistent, Bioaccumulative, and Toxic) or vPvB (Very Persistent and Very Bioaccumulative).

Additional Hazards:

Vapors are denser than air and may travel along the ground, potentially reaching distant ignition sources and posing a risk of flashback fires.

Despite proper grounding and bonding, this material can still accumulate an electrostatic charge.

If enough charge accumulates, it may lead to electrostatic discharge and ignite flammable air-vapor mixtures.

Exposure to this substance may increase the toxicity of other materials. Refer to Chapter 11 for further details.

PBT: Not applicable

vPvB: Not applicable

Endocrine-Disrupting Properties:

Listed under List II.



LAVA 20 CLEANER & PVC PRIMER

Safety Data Sheet

According to Regulation (EC) No. 1907/2006 (REACH) with its Amendment Regulation (EC) No. 1272/2008 (CLP) and EU 2020/878

Printing Date 15. 12. 2023

Version Number 4 (replaces version 3)

Revision: 15. 12. 2023

SECTION 3: Composition/information on ingredients

3.1 Substances

CAS Number: 78-93-3 Butanone - 100% by weight

Identification Numbers:

EC Number: 201-159-0

Index Number: 606-002-00-3

SVHC

This product does not contain any candidate SVHCs at concentrations of 0.1% or higher, as specified under Regulation (EC) No 1907/2006 (REACH), Article 59.

SECTION 4: First aid measures

4.1 General Information: Seek immediate medical assistance.

If Inhaled:

Move the person to an area with fresh air. If symptoms persist, consult a doctor.

If the person is unconscious, place them in a stable side position for safe transport.

In Case of Skin Contact:

Remove any contaminated clothing.

Rinse the skin thoroughly with soap and water.

If irritation continues, seek medical advice.

If in Contact with Eyes:

Rinse the eyes under running water for several minutes, ensuring they are open.

Remove contact lenses if present, and continue rinsing.

If symptoms persist, consult a healthcare professional.

Avoid using a strong water jet to prevent potential corneal damage.

If Swallowed:

Contact the emergency services for your location.

Do not induce vomiting; transport the person to the nearest medical facility for further care.

If vomiting occurs naturally, ensure the head is kept below the hips to reduce the risk of aspiration.

If symptoms such as fever over 101°F (38.3°C), shortness of breath, chest congestion, or persistent coughing/wheezing develop within 6 hours, seek medical attention immediately.

4.2 Key Symptoms and Effects, Both Acute and Delayed

Inhalation under normal use conditions is not typically hazardous. However, exposure to high concentrations may cause temporary irritation, burning sensations in the nose and throat, coughing, and breathing difficulties.

No specific risks under normal use.

Skin contact may lead to burning sensations, redness, or swelling.

Ingestion can cause nausea, vomiting, or diarrhea.

Eye irritation symptoms include burning, redness, swelling, and potential visual impairment.

If symptoms such as fever over 101°F (38.3°C), shortness of breath, chest congestion, or persistent cough/wheezing occur within 6 hours, seek medical help.



LAVA 20 CLEANER & PVC PRIMER

Safety Data Sheet

According to Regulation (EC) No. 1907/2006 (REACH) with its Amendment Regulation (EC) No. 1272/2008 (CLP) and EU 2020/878

Printing Date 15. 12. 2023

Version Number 4 (replaces version 3)

Revision: 15. 12. 2023

Ingestion leading to material entering the lungs may result in coughing, respiratory obstruction, wheezing, difficulty breathing, chest congestion, fast breathing (tachypnea), and fever.

Symptoms of dermatitis may manifest as burning sensations or skin dryness.

Breathing in high vapor concentrations can depress the central nervous system, leading to dizziness, headache, nausea, lack of coordination, and possibly unconsciousness or death with prolonged exposure.

4.3 Need for Immediate Medical Attention and Special Treatment

Immediate medical care is necessary.

Risk of chemical pneumonitis.

Contact a doctor or poison control center for specific instructions.

Treat based on symptoms.

SECTION 5: Firefighting measures

5.1 Extinguishing Media

Recommended Extinguishing Agents: Use water spray, alcohol-resistant foam, dry chemical powder, or carbon dioxide to extinguish fires.

5.2 Special Hazards from the Substance or Mixture

Vapors are denser than air and can travel along the ground, making distant ignition possible.

Incomplete combustion may produce a complex mix of airborne particles and gases, including carbon monoxide, along with unidentified organic and inorganic compounds.

5.3 Advice for Firefighters

Protective Gear: Firefighters should wear full protective suits (including clothing, helmets, boots, and gloves) compliant with European Standard EN 469. Cool any containers exposed to heat or flames.

Additional Information:

Collect contaminated firefighting water separately; it must not be allowed to enter the sewage system.

SECTION 6: Accidental release measures

6.1 Personal Precautions, Protective Equipment, and Emergency Procedures

Follow all relevant local and international regulations.

Notify authorities immediately if there is any actual or potential exposure to the public or environment.

Inform local authorities if substantial spills cannot be contained.

Vapors are heavier than air, capable of spreading along the ground, and may ignite from a distance.

Vapors can also form explosive mixtures with air.

6.1.1 For Non-Emergency Personnel

Avoid direct contact with any leaking or dripping materials.

Prevent contact with skin and eyes.

Utilize appropriate personal protective equipment (PPE).

6.1.2 For Emergency Responders

First-aid responders should wear protective clothing, gloves, goggles, and a respiratory device equipped with a type A filter.

Ensure protective gear is worn and restrict access to unprotected individuals.



LAVA 20 CLEANER & PVC PRIMER

Safety Data Sheet

According to Regulation (EC) No. 1907/2006 (REACH) with its Amendment Regulation (EC) No. 1272/2008 (CLP) and EU 2020/878

Printing Date 15. 12. 2023

Version Number 4 (replaces version 3)

Revision: 15. 12. 2023

6.2 Environmental Precautions

If safe to do so, stop leaks. Remove any ignition sources in the surrounding area.

Employ containment measures to prevent environmental contamination.

Prevent the substance from spreading or entering drains, waterways, or rivers using sand, soil, or other suitable barriers.

Attempt to disperse the vapor or direct it safely using fog sprays.

Take measures to prevent static discharge.

Ensure all equipment is bonded and grounded to maintain electrical continuity.

Thoroughly ventilate contaminated areas.

Monitor the environment with a combustible gas detector.

Do not allow the product to enter sewage systems, surface water, or groundwater.

6.3 Methods and Materials for Containment and Cleanup

For Large Liquid Spills (> 1 drum): Transfer the liquid using mechanical means, such as a vacuum truck, to a salvage tank for either recovery or safe disposal. Do not wash away residues with water; keep them as contaminated waste.

Allow any remaining residues to evaporate or absorb them with appropriate materials, then dispose of them safely. Remove and safely dispose of any contaminated soil.

For Small Liquid Spills (< 1 drum): Use mechanical methods to transfer the liquid into a labeled, sealable container for product recovery or disposal.

Let residues evaporate or absorb them with a suitable material, then dispose of them safely. Remove any contaminated soil and dispose of it appropriately. Dispose of contaminated materials as waste, following instructions in Section 13.

6.4 References to Other Sections

Refer to Section 7 for guidelines on safe handling.

See Section 8 for details on personal protective equipment.

Refer to Section 13 for disposal procedures.

SECTION 7: Handling and storage

7.1 Safe Handling Precautions

Open and handle containers carefully.

Ensure proper ventilation.

Avoid contact with eyes, skin, and clothing.

Do not inhale vapors.

Refrain from eating, drinking, or smoking while using this product.

Wash any contaminated clothing before reuse.

Wash hands before breaks and after completing work tasks.

Handle carefully to avoid jolting, friction, and impact.

Fire and Explosion Safety:

Keep away from ignition sources; smoking is prohibited.

Take measures to prevent electrostatic charges.

Do not spray near open flames or hot surfaces.

Empty containers can still form flammable gas-air mixtures.

Vapors can combine with air to create an explosive mix.





LAVA 20 CLEANER & PVC PRIMER

Safety Data Sheet

According to Regulation (EC) No. 1907/2006 (REACH) with its Amendment Regulation (EC) No. 1272/2008 (CLP) and EU 2020/878

Printing Date 15. 12. 2023

Version Number 4 (replaces version 3)

Revision: 15. 12. 2023

7.2 Storage Conditions and Incompatibilities

Storage:

Store in tightly sealed containers in a cool, dry, and well-ventilated area.

Vapors are denser than air and may accumulate in low-lying areas or confined spaces.

For specific legal requirements on packaging and storage, refer to Section 15.

Requirements for Storage Rooms and Containers:

Suitable Materials: Mild steel, stainless steel, and aluminum are recommended for containers or liners.

Unsuitable Materials: Avoid using natural rubber, butyl rubber, neoprene, or nitrile.

Container Guidelines:

Even empty containers may hold explosive vapors. Do not cut, drill, grind, weld, or perform similar operations on or near containers.

Additional Storage Information: Keep protected from direct sunlight.

7.3 Specific End Uses No further relevant information is available.

SECTION 8: Exposure controls/personal protection

8.1 Control parameters

Ingredients with limit values that require monitoring at the workplace:

CAS: 78-93-3 butanone

IOELV (EU)	Short-term value: 900 mg/m ³ , 300 ppm Long-term value: 600 mg/m ³ , 200 ppm
WEL (Great Britain)	Short-term value: 899 mg/m ³ , 300 ppm Long-term value: 600 mg/m ³ , 200 ppm Sk, BMGV

DNELs

(CAS: 78-93-3) butanone methyl ethyl ketone

Workers:

Dermal - long-term systemic effects: 1161 mg/kg bw/d

Inhalation - long-term systemic effects: 600 mg/m³.

Consumers:

Oral - long-term systemic effects: 31 mg/kg bw/d

Inhalation - long-term systemic effects: 106 mg/m³.

Dermal - long-term systemic effects: 412 mg/kg bw/d

PNECs

Exposure assessments have not been presented for the environment therefore PNEC values not required.

8.2 Exposure Controls

Engineering Measures:

Refer to the specific Exposure Scenario provided in the Annex for your particular use case.



LAVA 20 CLEANER & PVC PRIMER

Safety Data Sheet

According to Regulation (EC) No. 1907/2006 (REACH) with its Amendment Regulation (EC) No. 1272/2008 (CLP) and EU 2020/878

Printing Date 15. 12. 2023

Version Number 4 (replaces version 3)

Revision: 15. 12. 2023

The required level of protection and control measures will vary based on the conditions of potential exposure. Choose controls following a risk assessment of local conditions.

Appropriate measures include:

Utilize closed systems as much as possible.

Ensure sufficient explosion-proof ventilation to keep airborne concentrations below exposure guidelines or limits. Local exhaust ventilation is recommended.

Firewater monitors and deluge systems should be in place.

Provide emergency eye wash stations and safety showers.

When the material is heated, sprayed, or forms a mist, the likelihood of airborne concentrations increases, necessitating additional controls.

Individual Protection Measures, Including Personal Protective Equipment (PPE)

General Safety and Hygiene Practices:

Maintain good personal hygiene, such as washing hands after handling the product and before eating, drinking, or smoking.

Routinely clean work clothing and PPE to eliminate contaminants.

Dispose of contaminated clothing and footwear that cannot be properly cleaned.

Ensure safe handling procedures and proper maintenance of control measures.

Educate and train workers on hazards and control measures related to normal use of the product.

Verify appropriate selection, testing, and maintenance of equipment for exposure control, including PPE and local exhaust systems.

Drain down the system before equipment servicing or maintenance.

Keep drain downs in sealed containers for disposal or recycling.

Personal Protective Equipment (PPE):

Refer to the Exposure Scenario in the Annex for specific usage. Information provided here considers the PPE directive (Council Directive 89/686/EEC) and CEN standards. PPE must comply with national recommendations; consult with PPE suppliers.

Avoid inhaling vapors or mists.

Prevent contact with eyes and skin.

Do not eat, drink, or smoke while handling the product.

Thoroughly clean skin immediately after handling.

Respiratory Protection:



If engineering controls do not keep airborne concentrations at a safe level, choose respiratory protection equipment that matches the specific conditions and complies with relevant regulations.

Consult respiratory equipment suppliers for suitable options.

Where air-filtering respirators are not adequate (e.g., high concentrations, oxygen deficiency, confined spaces), use appropriate positive pressure breathing apparatus.

If air-filtering respirators are suitable, select a mask and filter combination that matches the conditions of use.



LAVA 20 CLEANER & PVC PRIMER

Safety Data Sheet

According to Regulation (EC) No. 1907/2006 (REACH) with its Amendment Regulation (EC) No. 1272/2008 (CLP) and EU 2020/878

Printing Date 15. 12. 2023

Version Number 4 (replaces version 3)

Revision: 15. 12. 2023

For organic gases and vapors, choose a filter conforming to EN141 [Filter type A, for organic gases and vapors with a boiling point >65°C (149°F)].

Hand Protection:



Use chemical-resistant gloves (EN 374) suitable for prolonged, direct contact. Recommended protection index 6, with permeation time > 480 minutes according to EN 374. Examples: nitrile rubber (0.4 mm), chloroprene rubber (0.5 mm), butyl rubber (0.7 mm). Select gloves based on penetration time, diffusion rate, and degradation resistance.

Glove Material Selection:

When hand contact with the product is possible, gloves made from materials such as butyl rubber or nitrile rubber are recommended for longer-term protection. For incidental or splash contact, PVC or neoprene rubber gloves may be suitable. For continuous contact, gloves with a breakthrough time of more than 240 minutes are recommended, ideally > 480 minutes where suitable gloves can be found. For short-term or splash protection, the same guidelines apply; however, where such gloves are not available, lower breakthrough times may be acceptable if proper maintenance and replacement routines are followed. Glove thickness alone is not an indicator of resistance; it depends on the glove's composition. Typically, thickness should be greater than 0.35 mm, depending on the glove's make and model. The suitability and durability of gloves depend on usage, such as the frequency and duration of contact, resistance of the material, and dexterity required. Seek advice from glove suppliers. Replace contaminated gloves. Personal hygiene is essential; gloves should only be worn on clean hands. After use, wash and dry hands thoroughly. A non-perfumed moisturizer is recommended.

Glove Penetration Time: ≥480 minutes

Penetration times as defined by EN 16523-1:2015 are not tested under practical conditions. Therefore, it is advisable to limit the wearing time to 50% of the stated penetration time.

Eye/Face Protection:



Wear safety glasses with side shields (frame goggles) compliant with EN 166.

Body Protection:



Wear antistatic and flame-resistant clothing if determined necessary by a local risk assessment. Under normal use conditions, additional skin protection is not required. For extended or repeated exposure, use impermeable clothing on body parts that may come into contact with the substance. If there is a



LAVA 20 CLEANER & PVC PRIMER

Safety Data Sheet

According to Regulation (EC) No. 1907/2006 (REACH) with its Amendment Regulation (EC) No. 1272/2008 (CLP) and EU 2020/878

Printing Date 15. 12. 2023

Version Number 4 (replaces version 3)

Revision: 15. 12. 2023

likelihood of repeated or prolonged skin contact, ensure the use of appropriate gloves that meet relevant standards, and implement skin care programs for employees. Protective clothing should comply with EU Standard EN14605.

SECTION 9: Physical and chemical properties

9.1 Information on basic physical and chemical properties

General Information

Physical state	Liquid
Colour:	Clear
Odour:	Characteristic
Odour threshold:	Not determined
Melting point/freezing point: Boiling point or initial boiling point and boiling range	79.5 °C
Flammability	Highly flammable
Lower and upper explosion limit Lower: Upper:	1.8 Vol % 11.5 Vol %
Flash point:	-9 °C (Abel)
Auto-ignition temperature:	515 °C
Decomposition temperature:	Not determined
pH	Not determined
Viscosity: Kinematic viscosity	Not determined



LAVA 20 CLEANER & PVC PRIMER

Safety Data Sheet

According to Regulation (EC) No. 1907/2006 (REACH) with its Amendment Regulation (EC) No. 1272/2008 (CLP) and EU 2020/878

Printing Date 15. 12. 2023

Version Number 4 (replaces version 3)

Revision: 15. 12. 2023

Dynamic at 20 °C:	0.42 mPas (ASTM D445)
Solubility water at 20 °C:	250 g/l
Partition coefficient n-octanol/water (log value)	0.3 log POW
Vapour pressure at 20 °C:	12600 Pa
Density and/or relative density Density at 20 °C: Relative density at 20 °C Vapour density at 20 °C	0.804-0.806 g/cm ³ (ASTM D4052) 0.804 - 0.806 g/cm ³ (ASTM D4052) 2.4
9.2 Other information	
Exhaust velocity:	3.3
Method:	DIN 53170, di-ethyl ether=1
Conductivity:	Electrical conductivity: > 10 000 pS/m Various factors such as liquid temperature, the presence of contaminants and antistatic additives can greatly influence the conductivity of a liquid.
Surface tension:	24,8 mN/m, 20 °C
Appearance:	
Form:	Liquid
Important information on protection of health and environment, and on safety. Ignition temperature:	Not determined.



LAVA 20 CLEANER & PVC PRIMER

Safety Data Sheet

According to Regulation (EC) No. 1907/2006 (REACH) with its Amendment Regulation (EC) No. 1272/2008 (CLP) and EU 2020/878

Printing Date 15. 12. 2023

Version Number 4 (replaces version 3)

Revision: 15. 12. 2023

Explosive properties:	Product is not explosive. However, formation of explosive air/ vapour mixtures are possible.
Molecular weight	72.11 g/mol
Drip point:	
Oxidising properties	Not oxidising
Evaporation rate	Not determined
Information with regard to physical hazard classes	
Explosives	Void
Flammable gases	Void
Aerosols	Void
Oxidising gases	Void
Gases under pressure	Void
Flammable liquids	Highly flammable liquid and vapour.
Flammable solids	Void
Self-reactive substances and mixtures	Void
Pyrophoric liquids	Void
Pyrophoric solids	Void
Self-heating substances and mixtures	Void



LAVA 20 CLEANER & PVC PRIMER

Safety Data Sheet

According to Regulation (EC) No. 1907/2006 (REACH) with its Amendment Regulation (EC) No. 1272/2008 (CLP) and EU 2020/878

Printing Date 15. 12. 2023

Version Number 4 (replaces version 3)

Revision: 15. 12. 2023

Substances and mixtures, which emit flammable gases in contact with water	Void
Oxidising liquids	Void
Oxidising solids	Void
Organic peroxides	Void
Corrosive to metals	Void
Desensitised explosives	Void

SECTION 10: Stability and reactivity

10.1 Reactivity Stable under standard conditions.

10.2 Chemical Stability The material remains stable under normal conditions.

Thermal Decomposition/Conditions to Avoid:

Prevent overheating to avoid thermal decomposition.

Stable at ambient temperatures.

10.3 Possibility of Hazardous Reactions May react with strong oxidizing agents.

10.4 Conditions to Avoid

Avoid exposure to heat, sparks, open flames, or other ignition sources.

Prevent the build-up of vapors.

Conditions that could generate static electricity may lead to ignition of vapors.

10.5 Incompatible Materials Strong oxidizing agents.

10.6 Hazardous Decomposition Products

Thermal decomposition depends greatly on the conditions. Combustion, thermal, or oxidative degradation can produce a complex mixture of airborne solids, liquids, and gases, including carbon monoxide, carbon dioxide, sulfur oxides, and unidentified organic compounds.

SECTION 11: Toxicological information

11.1 Information on Hazard Classes According to Regulation (EC) No 1272/2008

Acute Toxicity: The available data indicates that the product does not meet the classification criteria for acute toxicity.

LD/LC50 values relevant for classification: CAS: 78-93-3 butanone

Oral	LD50	>2000-≤5000 mg/kg (rat) (OECD 423)
Dermal	LD50	> 10 ml/kg/bw (rabbit) (OECD 402)



LAVA 20 CLEANER & PVC PRIMER

Safety Data Sheet

According to Regulation (EC) No. 1907/2006 (REACH) with its Amendment Regulation (EC) No. 1272/2008 (CLP) and EU 2020/878

Printing Date 15. 12. 2023

Version Number 4 (replaces version 3)

Revision: 15. 12. 2023

Skin corrosion/irritation

Species:	Rabbit
Method:	OECD Test Guideline 404
Test substance:	butan-2-ol
Remarks:	on the basis of the available data, the classification criteria are not met. Prolonged exposure may cause skin dryness or cracking.

Serious eye damage/irritation

Species:	Rabbit
Method:	Test(s) equivalent or similar to OECD Directive 405
Causes serious eye irritation.	

Respiratory or skin sensitisation

Species:	Guinea pig
Method:	OECD Test Guideline 406
Based on available data, the classification criteria are not met.	

Germ cell mutagenicity

Genotoxicity in vitro:	
Method: Remarks:	Test(s) equivalent or similar to OECD Guideline 471 Based on available data, the classification criteria are not met.
Method: Remarks:	Test(s) equivalent or similar to OECD Test Guideline 473 Based on available data, the classification criteria are not met.



LAVA 20 CLEANER & PVC PRIMER

Safety Data Sheet

According to Regulation (EC) No. 1907/2006 (REACH) with its Amendment Regulation (EC) No. 1272/2008 (CLP) and EU 2020/878

Printing Date 15. 12. 2023

Version Number 4 (replaces version 3)

Revision: 15. 12. 2023

Method: Remarks:	Test(s) equivalent or similar to OECD Test Guideline 476 Based on available data, the classification criteria are not met.
Method: Remarks:	Test(s) equivalent or similar to OECD Test Guideline 480 Based on available data, the classification criteria are not met.
Method: Remarks:	Test(s) equivalent or similar to OECD Test Guideline 482 Based on available data, the classification criteria are not met.

Genotoxicity in vivo:

Species:	Mouse
Method:	Test(s) equivalent or similar to OECD Test Guideline 474
Remarks:	Based on available data, the classification criteria are not met.

Germ cell mutagenicity Assessment: This product does not meet the criteria for classification in categories 1A/1B. Based on available data, the classification criteria are not met.

Carcinogenicity Based on available data, the classification criteria are not met.

Reproductive toxicity: Effects on fertility:

Species:	Rat
Sex:	male and female
Application Route:	Oral
Method:	Equivalent or similar to OECD Test Guideline 416
Test substance:	Butan-2-ol
Remarks:	Based on available data, the classification criteria are not met.

Reproductive toxicity: Assessment: This product does not meet the criteria for classification in categories 1A/1B. Based on available data, the classification criteria are not met.

STOT - Single Exposure This product is classified under Specific Target Organ Toxicity (Category 3) for single exposure. It may cause dizziness or drowsiness.

STOT - Repeated Exposure Based on current data, the product does not meet the criteria for classification under repeated exposure toxicity.



LAVA 20 CLEANER & PVC PRIMER

Safety Data Sheet

According to Regulation (EC) No. 1907/2006 (REACH) with its Amendment Regulation (EC) No. 1272/2008 (CLP) and EU 2020/878

Printing Date 15. 12. 2023

Version Number 4 (replaces version 3)

Revision: 15. 12. 2023

Aspiration Hazard The available information indicates that the product does not meet the criteria for classification as an aspiration hazard.

Additional toxicological information: Repeated dose toxicity

Species:	Rat, male and female
Application Route:	Inhalation
Test atmosphere:	vapour
Method:	Test(s) equivalent or similar to OECD Test Guideline 413
Target Organs:	No specific target organs noted
Based on available data, the classification criteria are not met.	

11.2 Information on Other Hazards

Endocrine Disrupting Properties: List II.

SECTION 12: Ecological information

12.1 Toxicity: Aquatic Toxicity:

Toxicity to Fish: Practically non-toxic; LL/EL/IL50 values exceed 100 mg/l.

Toxicity to Daphnia and Other Aquatic Invertebrates: EC50 (Daphnia magna - Water flea): 308 mg/l

Exposure duration: 48 hours

Method: OECD Test Guideline 202

Practically non-toxic; LL/EL/IL50 values exceed 100 mg/l.

Toxicity to Algae/Aquatic Plants:

EC50 (Selenastrum capricornutum - green algae): 2.029 mg/l

Exposure duration: 96 hours

Method: OECD Test Guideline 201

Practically non-toxic; LL/EL/IL50 values exceed 100 mg/l.

Chronic Toxicity to Fish and Daphnia: Data not available.

Toxicity to Microorganisms:

(Pseudomonas putida): 1.150 mg/l

Exposure time: 16 hours

Method: Other guideline method

Practically non-toxic; LL/EL/IL50 values exceed 100 mg/l.

12.2 Persistence and Degradability

Biodegradation: 98% within 28 days

Method: OECD Test Guideline 301D

Readily biodegradable; undergoes rapid oxidation through photochemical reactions in the air.



LAVA 20 CLEANER & PVC PRIMER

Safety Data Sheet

According to Regulation (EC) No. 1907/2006 (REACH) with its Amendment Regulation (EC) No. 1272/2008 (CLP) and EU 2020/878

Printing Date 15. 12. 2023

Version Number 4 (replaces version 3)

Revision: 15. 12. 2023

12.3 Bioaccumulative Potential

The substance does not show significant bioaccumulation.

Partition Coefficient (n-octanol/water): log Pow: 0.3

12.4 Mobility in Soil

Dissolves readily in water.

12.5 Results of PBT and vPvB Assessment

The substance does not meet the criteria for persistence, bioaccumulation, and toxicity, and therefore is not classified as PBT (Persistent, Bioaccumulative, and Toxic) or vPvB (Very Persistent and Very Bioaccumulative).

PBT: Not applicable

vPvB: Not applicable

12.6 Endocrine Disrupting Properties

For details on endocrine-disrupting characteristics, refer to Sections 2.3 and 11.2.

12.7 Other Adverse Effects

The substance does not contribute to ozone depletion.

SECTION 13: Disposal considerations

13.1 Waste Treatment Methods

Recommendation:

Dispose of the material and its containers safely. Exercise caution when handling empty containers that have not been thoroughly cleaned.

Empty containers or liners may still contain product residues. Vapors from these residues can form a highly flammable or explosive atmosphere within the container.

Do not cut, weld, or grind used containers unless they have been completely cleaned inside.

Prevent the spread of spilled material and avoid letting it come into contact with soil or drainage systems.



Follow national regulations for proper disposal.

Do not dispose of with household waste, and ensure the product does not enter sewage systems.

Contact manufacturer for recycling information.

European Waste Catalogue

HP3	Flammable
HP4	Irritant - skin irritation and eye damage
HP5	Specific Target Organ Toxicity (STOT)/Aspiration Toxicity



LAVA 20 CLEANER & PVC PRIMER

Safety Data Sheet

According to Regulation (EC) No. 1907/2006 (REACH) with its Amendment Regulation (EC) No. 1272/2008 (CLP) and EU 2020/878

Printing Date 15. 12. 2023

Version Number 4 (replaces version 3)

Revision: 15. 12. 2023

Uncleaned Packaging:

Recommendation:

Warning for Empty Containers (if applicable): Empty containers may still contain residues and can pose hazards. Do not attempt to refill or clean containers without following proper guidelines.

Licensed drums should be thoroughly drained and stored safely until they can be processed or disposed of appropriately.

Dispose of empty containers through recycling, recovery, or certified waste management services, following all relevant government regulations.

Do not crush, cut, weld, puncture, or expose containers to heat, flame, sparks, or static electricity, as they may explode, leading to injury or fatality.

Disposal should adhere to official regulations.

Packaging may be reused or recycled after proper cleaning.

SECTION 14: Transport information

14.1 UN number or ID number ADR, IMDG, IATA	UN1193
14.2 UN proper shipping name ADR IMDG, IATA	1193 ETHYL METHYL KETONE (METHYL ETHYL KETONE) ETHYL METHYL KETONE (METHYL ETHYL KETONE)
14.3 Transport hazard class(es) ADR, IMDG, IATA  Class Label	3 Flammable liquids. 3
14.4 Packing group ADR, IMDG, IATA	II
14.5 Environmental hazards:	Not applicable.
14.6 Special precautions for user	Warning: Flammable liquids.



LAVA 20 CLEANER & PVC PRIMER

Safety Data Sheet

According to Regulation (EC) No. 1907/2006 (REACH) with its Amendment Regulation (EC) No. 1272/2008 (CLP) and EU 2020/878

Printing Date 15. 12. 2023

Version Number 4 (replaces version 3)

Revision: 15. 12. 2023

Hazard identification number (Kemler code):	33
EMS Number:	F-E,S-D
Stowage Category 14.7 Maritime transport in bulk according to IMO instruments	Not applicable.
Transport/Additional information:	
ADR Limited quantities (LQ) Excepted quantities (EQ)	1L Code: E2 Maximum net quantity per inner packaging: 30 ml Maximum net quantity per outer packaging: 500 ml
Transport category	2
Tunnel restriction code	D/E
IMDG Limited quantities (LQ) Excepted quantities (EQ)	1L Code: E2 Maximum net quantity per inner packaging: 30 ml Maximum net quantity per outer packaging: 500 ml
UN "Model Regulation":	UN 1193 ETHYL METHYL KETONE (METHYL ETHYL KETONE), 3, II

SECTION 15: Regulatory information

15.1 Safety, Health, and Environmental Regulations/Legislation Specific to the Substance or Mixture

Relevant Regulations:

REACH Regulation (EC) No 1907/2006

Regulation (EU) 2020/878

CLP Regulation (EC) No 1272/2008

Directive 98/24/EC on protecting the health and safety of workers from risks associated with chemical agents

Council Directive 94/33/EC on protecting young workers, as amended



LAVA 20 CLEANER & PVC PRIMER

Safety Data Sheet

According to Regulation (EC) No. 1907/2006 (REACH) with its Amendment Regulation (EC) No. 1272/2008 (CLP) and EU 2020/878

Printing Date 15. 12. 2023

Version Number 4 (replaces version 3)

Revision: 15. 12. 2023

Directive 92/85/EEC promoting safety and health measures for pregnant employees, new mothers, and breastfeeding workers, as amended

Directive 2012/18/EU Dangerous Substances - Annex I: The substance is not listed in Annex I.

Seveso Category:

P5c: Flammable Liquids

Lower-tier Threshold: 5,000 tonnes

Upper-tier Threshold: 50,000 tonnes

REACH Regulation (EC) No 1907/2006 - Annex XVII: Conditions of restriction: 3

Directive 2011/65/EU (RoHS) - Annex II: The substance is not listed as a restricted hazardous material in electrical and electronic equipment.

Regulation (EU) 2019/1148: Annex I - Restricted Explosives Precursors: The substance is not included (upper limit for licensing per Article 5(3)).

Annex II - Reportable Explosives Precursors: Not listed.

Drug Precursor Regulations:

Regulation (EC) No 273/2004: Substance is not listed.

Regulation (EC) No 111/2005: Substance is not listed.

National Regulations: No specific national regulations apply.

Other Regulations, Limitations, and Restrictions: Substances of Very High Concern (SVHC) as Defined by REACH Article 57: The substance is not classified as SVHC.

15.2 Chemical Safety Assessment: A chemical safety report has been conducted.

SECTION 16: Other information

This information reflects our current understanding. However, it does not serve as a guarantee of specific product properties and does not create a legally binding agreement.

Training Recommendations:

Employees should receive proper training on the safe handling, storage, and use of the product, utilizing all available information.

Classification According to Regulation (EC) No 1272/2008

Department issuing SDS:



OWL WATERPROOFING SOLUTIONS

135 Slaney Road, Dublin Industrial Estate

Glasnevin, Dublin 11

Tel: +353 01 830 2250

Email: info@owlwaterproofing.co.uk

Website: www.owlwaterproofing.co.uk

Version number of previous version: 3

Abbreviations and acronyms:

ADR: Accord relatif au transport international des marchandises dangereuses par route (European Agreement Concerning the International Carriage of Dangerous Goods by Road)

IMDG: International Maritime Code for Dangerous Goods

IATA: International Air Transport Association

GHS: Globally Harmonised System of Classification and Labelling of Chemicals

EINECS: European Inventory of Existing Commercial Chemical Substances

CAS: Chemical Abstracts Service (division of the American Chemical Society)



LAVA 20 CLEANER & PVC PRIMER

Safety Data Sheet

According to Regulation (EC) No. 1907/2006 (REACH) with its
Amendment Regulation (EC) No. 1272/2008 (CLP) and EU 2020/878

Printing Date 15. 12. 2023

Version Number 4 (replaces version 3)

Revision: 15. 12. 2023

DNEL: Derived No-Effect Level (REACH)

PNEC: Predicted No-Effect Concentration (REACH)

LC50: Lethal concentration, 50 percent

LD50: Lethal dose, 50 percent

PBT: Persistent, Bioaccumulative and Toxic

SVHC: Substances of Very High Concern

vPvB: very Persistent and very Bioaccumulative

Flam. Liq. 2: Flammable liquids – Category 2

Eye Irrit. 2: Serious eye damage/eye irritation – Category 2

STOT SE 3: Specific target organ toxicity (single exposure) – Category 3

*** Data compared to the previous version altered.**



LAVA 20 EPDM & TPO PRIMER

Safety Data Sheet

According to Regulation (EC) No. 1907/2006 (REACH) with its Amendment Regulation (EC) No. 1272/2008 (CLP) and EU 2020/878

Printing Date 14. 12. 2023

Version Number 2 (replaces version 1)

Revision: 14. 12. 2023

SECTION 1: Identification of the substance/mixture and of the company/undertaking

1.1 Product identifier

Trade name: LAVA 20 EPDM & TPO PRIMER

1.2 Relevant identified uses of the substance or mixture and uses advised against Professional use

Application of the substance / the mixture: Bonding Enhancer

1.3 Details of the supplier of the safety data sheet

Manufacturer/Supplier:

OWL WATERPROOFING SOLUTIONS

135 Slaney Road, Dublin Industrial Estate

Glasnevin, Dublin 11

Tel: +353 01 830 2250

Email: info@owlwaterproofing.co.uk

Website: www.owlwaterproofing.co.uk

1.4 Emergency telephone number:

European Emergency Tel.: +353 01 830 2250

SECTION 2: Hazards identification

2.1 Substance or Mixture Classification

Classification as per Regulation (EC) No 1272/2008 (CLP):

GHS02 flame



Flam. Liq. 3 H226 Flammable liquid and vapour

GHS08 health hazard



STOT RE 2 H373 May cause damage to the hearing organs through prolonged or repeated exposure.
Asp. Tox. 1 H304 May be fatal if swallowed and enters airways.

GHS07



Acute Tox. 4 H312 Harmful in contact with skin.
Acute Tox. 4 H332 Harmful if inhaled.
Skin Irrit. 2 H315 Causes skin irritation.
Eye Irrit. 2 H319 Causes serious eye irritation.
STOT SE 3 H335 May cause respiratory irritation.

2.2 Label Elements

Labelling in Accordance with Regulation (EC) No 1272/2008 (CLP): This product is classified and labelled in compliance with the CLP regulation.



LAVA 20 EPDM & TPO PRIMER

Safety Data Sheet

According to Regulation (EC) No. 1907/2006 (REACH) with its Amendment Regulation (EC) No. 1272/2008 (CLP) and EU 2020/878

Printing Date 14. 12. 2023

Version Number 2 (replaces version 1)

Revision: 14. 12. 2023

Hazard pictograms:



GHS02 GHS07 GHS08

Signal word: Danger

Hazard-determining components of labelling:

Reaction mass of ethylbenzene and xylene
Xylene mixture of isomers
ethylbenzene

Hazard statements:

H226 Flammable liquid and vapour.
H312+H332 Harmful in contact with skin or if inhaled.
H315 Causes skin irritation.
H319 Causes serious eye irritation.
H335 May cause respiratory irritation.
H373 May cause damage to the hearing organs through prolonged or repeated exposure.
H304 May be fatal if swallowed and enters airways.

Precautionary statements

P210 Keep away from heat, hot surfaces, sparks, open flames and other ignition sources. No smoking.
P260 Do not breathe dust/fume/gas/mist/vapours/spray.
P280 Wear protective gloves/protective clothing/eye protection/face protection/hearing protection.
P302+P352 IF ON SKIN: Wash with plenty of water and soap.
P331 Do NOT induce vomiting.
P501 Dispose of contents/container in accordance with local/regional/national/international regulations.

2.3 Other Hazards

PBT and vPvB Assessment:

This product does not contain any substances identified as persistent, bioaccumulative, and toxic (PBT) or very persistent and very bioaccumulative (vPvB) at concentrations of 0.1% or more.

PBT: Not applicable

vPvB: Not applicable

Assessment of Endocrine-Disrupting Properties:

The product does not include substances listed under Article 59(1) of REACH for endocrine-disrupting properties, nor has it been identified as having such properties based on the criteria specified in Commission Delegated Regulation (EU) 2017/2100 or Commission Regulation (EU) 2018/605 at levels of 0.1% or higher.



LAVA 20 EPDM & TPO PRIMER

Safety Data Sheet

According to Regulation (EC) No. 1907/2006 (REACH) with its Amendment Regulation (EC) No. 1272/2008 (CLP) and EU 2020/878

Printing Date 14. 12. 2023

Version Number 2 (replaces version 1)

Revision: 14. 12. 2023

SECTION 3: Composition/information on ingredients

3.2 Mixtures

Description: This is a mixture composed of the following components.

Ingredients According to Regulation (EU) 2020/878:

EC number: 905-588-0 Reg.nr.: 01-2119486136-34-XXXX	Reaction mass of ethylbenzene and xylene Flam. Liq. 3, H226; STOT RE 2, H373; Asp. Tox. 1, H304; Acute Tox. 4, H312; Acute Tox. 4, H332; Skin Irrit. 2, H315; Eye Irrit. 2, H319; STOT SE 3, H335	≥90-<93%
CAS: 1330-20-7 EINECS: 215-535-7 Index number: 601-022-00-9 Reg.nr.: 01-2119488216-32-XXXX	Xylene mixture of isomers Flam. Liq. 3, H226; STOT RE 2, H373; Asp. Tox. 1, H304; Acute Tox. 4, H312; Skin Irrit. 2, H315; Eye Irrit. 2, H319; STOT SE 3, H335 substance with a Community workplace exposure limit	≥5-<7%
CAS: 100-41-4 EINECS: 202-849-4 Index number: 601-023-00-4 Reg.nr.: 01-2119489370-35-XXXX	ethylbenzene Flam. Liq. 2, H225; STOT RE 2, H373; Asp. Tox. 1, H304; Acute Tox. 4, H332 substance with a Community workplace exposure limit	≥1-<2.5%

SVHC

This product does not include any candidate SVHCs at concentrations of 0.1% or higher, as specified by Regulation (EC) No 1907/2006 (REACH), Article 59.

SECTION 4: First aid measures

4.1 First Aid Measures

General Advice:

Immediately remove any clothing contaminated by the product.

Move the affected person to an area with fresh air.

Seek medical attention immediately.

If Inhaled:

If the person is unconscious, place them on their side in a stable position for transport.

Provide fresh air and, if necessary, administer artificial respiration. Keep the person warm.

Seek medical advice if symptoms persist.

Obtain immediate medical assistance.



LAVA 20 EPDM & TPO PRIMER

Safety Data Sheet

According to Regulation (EC) No. 1907/2006 (REACH) with its Amendment Regulation (EC) No. 1272/2008 (CLP) and EU 2020/878

Printing Date 14. 12. 2023

Version Number 2 (replaces version 1)

Revision: 14. 12. 2023

If in Contact with Skin:

Wash the area immediately with water and soap, then rinse thoroughly.

Seek prompt medical attention.

If in Contact with Eyes:

Rinse the eyes under running water for several minutes. Remove contact lenses if present, and continue rinsing.

If symptoms persist, consult a doctor.

Avoid using a strong water jet as it may damage the cornea; seek medical advice.

If Swallowed:

Call for immediate medical assistance.

Do not induce vomiting; seek emergency medical help.

Drink plenty of water and move to an area with fresh air. Contact a doctor right away.

4.2 Key Symptoms and Effects, Acute and Delayed

No additional relevant information is available.

4.3 Immediate Medical Attention and Special Treatment

No further relevant information is provided.

SECTION 5: Firefighting measures

5.1 Extinguishing Media

Appropriate Extinguishing Methods: Use CO₂, dry powder, or water spray to extinguish fires.

Inappropriate Extinguishing Methods: Avoid using a full jet of water for safety reasons.

5.2 Special Hazards from the Substance or Mixture Potential release of carbon dioxide (CO₂) and carbon monoxide (CO).

5.3 Firefighting Advice

Protective Gear: Firefighters should use respiratory protective devices and wear fully protective suits.

Additional Information: Collect firefighting water that has been contaminated separately, ensuring it does not enter the sewage system.

SECTION 6: Accidental release measures

6.1 Personal Precautions, Protective Gear, and Emergency Procedures

Wear appropriate protective gear and keep unprotected individuals at a safe distance.

Stay away from sources of ignition.

Avoid breathing in vapors and ensure sufficient ventilation.

Prevent contact with skin and eyes.

6.1.1 For Non-Emergency Personnel

Use suitable personal protective equipment.

Avoid contact with any dripping or leaking material.

6.1.2 For Emergency Responders

First-aid responders should wear protective clothing, gloves, goggles, and a respiratory device equipped with a type A filter.

6.2 Environmental Precautions

Prevent the material from entering sewers, surface water, or groundwater.



LAVA 20 EPDM & TPO PRIMER

Safety Data Sheet

According to Regulation (EC) No. 1907/2006 (REACH) with its Amendment Regulation (EC) No. 1272/2008 (CLP) and EU 2020/878

Printing Date 14. 12. 2023

Version Number 2 (replaces version 1)

Revision: 14. 12. 2023

6.3 Containment and Cleanup Methods

Use absorbent materials, such as sand or diatomite, to collect the substance.

6.4 References to Other Sections

Refer to Section 7 for details on safe handling procedures.

Refer to Section 8 for information on personal protective equipment.

Refer to Section 13 for proper disposal guidelines.

SECTION 7: Handling and storage

7.1 Safe Handling Precautions

Ensure proper ventilation or exhaust at the workplace.

Avoid direct contact with skin, eyes, and clothing.

Do not eat, drink, or smoke while handling the product.

Wash any contaminated clothing before wearing it again.

Thoroughly wash hands after use.

Fire and Explosion Safety:

Keep ignition sources away and do not smoke.



Prevent the buildup of electrostatic charges.

Keep away from heat, sparks, open flames, and hot surfaces.

7.2 Safe Storage Conditions, Including Incompatibilities

Storage: Store in tightly sealed containers in well-ventilated, cool areas.

Storage Room and Container Requirements: Maintain a cool environment for storage.

Common Storage Guidelines: Keep away from oxidizing agents.

Additional Storage Information: Protect the product from heat and direct sunlight. Ensure storage areas are locked.

Recommended storage temperature: between +2°C and 40°C.

7.3 Specific End Uses No additional relevant information available.

SECTION 8: Exposure controls/personal protection

8.1 Control Parameters

Ingredients with Workplace Limit Values

CAS: 1330-20-7 Xylene mixture of isomers

IOELV (EU)	Short-term value: 442 mg/m ³ , 100 ppm Long-term value: 221 mg/m ³ , 50 ppm Skin
WEL (Great Britain)	Short-term value: 441 mg/m ³ , 100 ppm Long-term value: 220 mg/m ³ , 50 ppm Sk; BMGV



LAVA 20 EPDM & TPO PRIMER

Safety Data Sheet

According to Regulation (EC) No. 1907/2006 (REACH) with its Amendment Regulation (EC) No. 1272/2008 (CLP) and EU 2020/878

Printing Date 14. 12. 2023

Version Number 2 (replaces version 1)

Revision: 14. 12. 2023

CAS: 100-41-4 ethylbenzene

IOELV (EU)	Short-term value: 884 mg/m ³ , 200 ppm Long-term value: 442 mg/m ³ , 100 ppm Skin
WEL (Great Britain)	Short-term value: 552 mg/m ³ , 125 ppm Long-term value: 441 mg/m ³ , 100 ppm Sk

DNELs

(EC: 905-588-0) ethylbenzene and xylene reaction mass

Workers:

Long-term systemic effect, by inhalation: 221 mg/m³

Long-term local effect, by inhalation: 221 mg/m³

Short-term local effect, by inhalation: 442 mg/m³

Long-term systemic effect, dermal: 212 mg/kg bw/d

Consumers:

Long-term systemic effect, inhalation: 65.3 mg/m³

Short-term systemic effect, inhalation: 260 mg/m³

Long-term local effect, inhalation: 65,3 mg/m³

Short-term local effect, inhalation: 260 mg/m³

Long-term systemic effect, dermal: 125 mg/kg bw/d

Long-term systemic effect, oral: 12,5 mg/kg bw/d

(CAS: 1330-20-7) Xylene (mixture of isomers)

Workers:

Inhalation - Long-term systemic effect: 221 mg/m³

Inhalation - Short-term acute effect: 442 mg/m³

Inhalation - Long-term local effect: 221 mg/m³

Dermal - Long-term systemic effect: 212 mg/kg bw/d

Consumers:

Inhalation - Long-term systemic effect: 65.3 mg/m³

Inhalation - Short-term acute effect: 260 mg/m³

Inhalation - Long-term local effect: 65,3 mg/m³

Dermal - Long-term systemic effect: 125 mg/kg bw/d

Oral - Long-term systemic effect: 12,5 mg/kg bw/d

(CAS: 100-41-4) Ethylbenzene

Workers:

Inhalation - Long-term systemic effect: 77 mg/m³

Inhalation - Long-term local effect: 293 mg/m³

Dermal - Long-term systemic effect: 180 mg/kg bw/d



LAVA 20 EPDM & TPO PRIMER

Safety Data Sheet

According to Regulation (EC) No. 1907/2006 (REACH) with its Amendment Regulation (EC) No. 1272/2008 (CLP) and EU 2020/878

Printing Date 14. 12. 2023

Version Number 2 (replaces version 1)

Revision: 14. 12. 2023

Consumers:

Inhalation - Long-term systemic effect: 15 mg/m³

Oral - Long-term systemic effect: 1,6 mg/kg bw/d

PNECs

(EC: 905-588-0) Reaction mass of xylene and ethylbenzene

Fresh water: 0,327 mg/l

Marine water: 0,327 mg/l

STP: 6,58 mg/l

Fresh water sediment: 12,46 mg/kg sediment dw

Marine water sediment: 12,46 mg/kg sediment dw

Soil: 2,31 mg/kg soil dw

CAS: 1330-20-7 Xylene (mixture of isomers)

STP: 6.58 mg/l

Freshwater: 0.327 mg/l

Soil: 2.31 mg/kg

Marine water: 0.327 mg/l

Intermittent releases: 0.327 mg/l

Sediment (freshwater): 12.46 mg/kg

Sediment (marinewater): 12.46 mg/kg

CAS: 100-41-4 Ethylbenzene

STP 9.6 mg/L

Freshwater: 0.1 mg/l

Soil 2,68 mg/kg

Marine water: 0.01 mg/l

Intermittent releases: 0.1 mg/l

Sediment (freshwater): 13.7 mg/kg

For oral use: 20 g/kg

Sediment (marinewater): 1.37 mg/kg

8.2 Exposure Controls

8.2.1 Appropriate Engineering Controls Ensure sufficient ventilation in the working area.

Individual Protection Measures (Personal Protective Equipment):

General Safety and Hygiene Practices:

Keep away from food, beverages, and animal feed.

Wash hands thoroughly before breaks and after completing work.

Remove contaminated clothing and wash before reuse.

Prevent contact with eyes and skin.

Avoid inhaling vapors or mists.

Do not eat, drink, or smoke while handling the product.



LAVA 20 EPDM & TPO PRIMER

Safety Data Sheet

According to Regulation (EC) No. 1907/2006 (REACH) with its Amendment Regulation (EC) No. 1272/2008 (CLP) and EU 2020/878

Printing Date 14. 12. 2023

Version Number 2 (replaces version 1)

Revision: 14. 12. 2023

Respiratory Protection:



In areas with insufficient ventilation, use an appropriate respiratory device. Respiratory protection is essential in poorly ventilated environments and during spraying. For short-term tasks, a combination of charcoal and particulate filter A2-P2 (EN529) is recommended, or use an air-fed mask for extended exposure.

Hand Protection:



Wear chemical-resistant gloves that comply with EN 374-1 standards. Gloves should be impermeable and resistant to the specific substances in the product. Select glove material based on penetration time, diffusion rate, and resistance to degradation.

Recommended Glove Materials for Handling at Room Temperature:

Butyl rubber (IIR): Thickness $\geq 0.5\text{mm}$, breakthrough time ≥ 480 minutes.

Fluorinated rubber (FKM): Thickness $\geq 0.4\text{mm}$, breakthrough time ≥ 480 minutes.

Contaminated gloves should be disposed of.

The choice of gloves should not only consider the material but also other quality indicators, which can vary between manufacturers. Since the product is a blend of multiple substances, test the glove's resistance before use.

Penetration Time for Glove Material: Penetration times determined under EN 16523-1:2015 conditions may not reflect practical usage. Therefore, it is advisable to limit the wearing time to 50% of the stated penetration time.

Eye/Face Protection:



Wear safety glasses with side shields (e.g., frame goggles compliant with EN 166).

Body Protection:



Use protective clothing and boots that are chemically resistant, as per EN 14605 standards.

SECTION 9: Physical and chemical properties

9.1 Information on basic physical and chemical properties

General Information

Physical state

Liquid



LAVA 20 EPDM & TPO PRIMER

Safety Data Sheet

According to Regulation (EC) No. 1907/2006 (REACH) with its Amendment Regulation (EC) No. 1272/2008 (CLP) and EU 2020/878

Printing Date 14. 12. 2023

Version Number 2 (replaces version 1)

Revision: 14. 12. 2023

Colour:	According to product specification
Odour:	Characteristic
Odour threshold:	Not determined
Melting point/freezing point:	Not determined
Flammability	Not applicable
Lower and upper explosion limit Lower: Upper:	Not determined Not determined
Flash point:	27 °C (Reaction mass of ethylbenzene and xylene)
Auto-ignition temperature:	488 °C (Reaction mass of ethylbenzene and xylene)
Decomposition temperature:	Not determined
pH	Not determined
Viscosity: Kinematic viscosity at 23 °C Dynamic:	10 s (DIN CUP 6mm) Not determined
Solubility water:	Not determined
Partition coefficient n-octanol/water (log value)	Not determined
Vapour pressure:	Not determined
Density and/or relative density Density at 20 °C:	0.88 g/cm ³



LAVA 20 EPDM & TPO PRIMER

Safety Data Sheet

According to Regulation (EC) No. 1907/2006 (REACH) with its Amendment Regulation (EC) No. 1272/2008 (CLP) and EU 2020/878

Printing Date 14. 12. 2023

Version Number 2 (replaces version 1)

Revision: 14. 12. 2023

Relative density Vapour density	Not determined Not determined
9.2 Other information	
Appearance: Form:	Liquid
Important information on protection of health and environment, and on safety. Ignition temperature: Explosive properties:	Product is not selfigniting. Product is not explosive. However, formation of explosive air/vapour mixtures are possible.
Solvent content: VOC (EC)	860 g/l
Drip point: Oxidising properties	Not oxidising
Evaporation rate	Not determined
Information with regard to physical hazard classes	
Explosives	Void
Flammable gases	Void
Aerosols	Void
Oxidising gases	Void
Gases under pressure	Void
Flammable liquids	Flammable liquid and vapour.



LAVA 20 EPDM & TPO PRIMER

Safety Data Sheet

According to Regulation (EC) No. 1907/2006 (REACH) with its Amendment Regulation (EC) No. 1272/2008 (CLP) and EU 2020/878

Printing Date 14. 12. 2023

Version Number 2 (replaces version 1)

Revision: 14. 12. 2023

Flammable solids	Void
Self-reactive substances and mixtures	Void
Pyrophoric liquids	Void
Pyrophoric solids	Void
Self-heating substances and mixtures	Void
Substances and mixtures, which emit flammable gases in contact with water	Void
Oxidising liquids	Void
Oxidising solids	Void
Organic peroxides	Void
Corrosive to metals	Void
Desensitised explosives	Void
Evaporation rate	Not determined
Information with regard to physical hazard classes	
Explosives	Void
Flammable gases	Void
Aerosols	Void
Oxidising gases	Void



LAVA 20 EPDM & TPO PRIMER

Safety Data Sheet

According to Regulation (EC) No. 1907/2006 (REACH) with its Amendment Regulation (EC) No. 1272/2008 (CLP) and EU 2020/878

Printing Date 14. 12. 2023

Version Number 2 (replaces version 1)

Revision: 14. 12. 2023

Gases under pressure	Void
Flammable liquids	Flammable liquid and vapour.
Flammable solids	Void
Self-reactive substances and mixtures	Void
Pyrophoric liquids	Void
Pyrophoric solids	Void
Self-heating substances and mixtures	Void
Substances and mixtures, which emit flammable gases in contact with water	Void
Oxidising liquids	Void
Oxidising solids	Void
Organic peroxides	Void
Corrosive to metals	Void
Desensitised explosives	Void

SECTION 10: Stability and reactivity

10.1 Reactivity No additional relevant information is available.

10.2 Chemical Stability The product remains stable under normal environmental temperatures, with no thermal decomposition expected.

10.3 Potential for Hazardous Reactions No known hazardous reactions under standard conditions.

10.4 Conditions to Avoid Avoid exposure to heat, sparks, open flames, or any other ignition sources.

10.5 Incompatible Materials Strong oxidizing agents.

10.6 Hazardous Decomposition Products May release carbon dioxide (CO₂) and carbon monoxide (CO) upon decomposition.



LAVA 20 EPDM & TPO PRIMER

Safety Data Sheet

According to Regulation (EC) No. 1907/2006 (REACH) with its Amendment Regulation (EC) No. 1272/2008 (CLP) and EU 2020/878

Printing Date 14. 12. 2023

Version Number 2 (replaces version 1)

Revision: 14. 12. 2023

SECTION 11: Toxicological information

11.1 Information on Hazard Classes According to Regulation (EC) No 1272/2008

Acute Toxicity: Harmful if it comes into contact with the skin or is inhaled.

LD/LC50 Values Relevant for Classification: (EC: 905-588-0) Reaction mass of ethylbenzene and xylene.

Oral	LD50	3,523 mg/kg bw (rat)
Dermal	LD50	12,126 mg/kg (rabbit)
Inhalation	LC50 (4h)	27,124 mg/m ³ (rat)

ATE (Acute Toxicity Estimates)

Dermal	LD50	1,196 mg/kg
Inhalation	LC50/4h (vapour)	12 mg/l

CAS: 1330-20-7 Xylene mixture of isomers

Oral	LD50	>3,523 mg/kg (rat)
Dermal	LD50	>12,126 mg/kg (rabbit)
Inhalation	LC50/4h (vapour)	>27 mg/l (rat)

CAS: 100-41-4 ethylbenzene

Oral	LD50	3,500 mg/kg (rat)
Dermal	LD50	17,800 mg/kg (rabbit)
Inhalation	LC50 (4h)	4,000 ppm (rat)

Skin Corrosion/Irritation: Causes irritation to the skin.

Serious Eye Damage/Irritation: Leads to serious eye irritation.

Respiratory or Skin Sensitization: Available data does not indicate a need for classification.

Germ Cell Mutagenicity: No evidence supports classification for mutagenicity based on available data.

Carcinogenicity: There is no indication of carcinogenic effects according to current data.



LAVA 20 EPDM & TPO PRIMER

Safety Data Sheet

According to Regulation (EC) No. 1907/2006 (REACH) with its Amendment Regulation (EC) No. 1272/2008 (CLP) and EU 2020/878

Printing Date 14. 12. 2023

Version Number 2 (replaces version 1)

Revision: 14. 12. 2023

Reproductive Toxicity: The product does not meet classification criteria for reproductive toxicity.

STOT - Single Exposure: Classified as Specific Target Organ Toxicity (Category 3) for single exposure.

May cause irritation to the respiratory system.

STOT - Repeated Exposure: Classified under Specific Target Organ Toxicity (Category 2) due to prolonged or repeated exposure. Prolonged exposure may damage the hearing organs.

Aspiration Hazard: Categorized under Aspiration Toxicity (Category 1). May be fatal if ingested and enters the respiratory tract.

11.2 Information on Other Hazards

Endocrine Disrupting Properties:

The product does not contain substances listed under Article 59(1) of REACH for endocrine-disrupting effects, nor does it meet the criteria defined by Commission Delegated Regulation (EU) 2017/2100 or Commission Regulation (EU) 2018/605 at concentrations of 0.1% or more.

No ingredients are listed as endocrine disruptors.

SECTION 12: Ecological information

12.1 Toxicity

Aquatic toxicity:

(EC: 905-588-0) Reaction mass of ethylbenzene and xylene

NOEC (56 d)	> 1.3 mg/l (Fish)
EC50 (72h)	>3.4 mg/l (Algae)
LC50	2.6 - 11.23 mg/l (Fish)
NOEC _r (72h)	0.44 mg/l (Algae)

CAS: 1330-20-7 Xylene mixture of isomers

EC50 (72h)	4.6-4.9 mg/l (algae)
EC50 (48h)	>10 mg/l (Daphnia magna)
LC50 (96h)	>2.6 mg/l (fish)
NOEC (21d)	1.57 mg/l (Daphnia magna)
EC50(24h)	>1 mg/l (Daphnia magna)



LAVA 20 EPDM & TPO PRIMER

Safety Data Sheet

According to Regulation (EC) No. 1907/2006 (REACH) with its Amendment Regulation (EC) No. 1272/2008 (CLP) and EU 2020/878

Printing Date 14. 12. 2023

Version Number 2 (replaces version 1)

Revision: 14. 12. 2023

CAS: 100-41-4 ethylbenzene

EC50 (48h)	73 mg/l (daphnia magna)
------------	-------------------------

12.2 Persistence and Degradability No additional relevant information is available.

12.3 Bioaccumulative Potential No further relevant data is available.

12.4 Mobility in Soil No additional information is available.

12.5 PBT and vPvB Assessment

This product does not contain any ingredients classified as persistent, bioaccumulative, and toxic (PBT) or very persistent and very bioaccumulative (vPvB) at concentrations of 0.1% or more, as outlined in REACH Annex XIII.

PBT: Not applicable

vPvB: Not applicable

12.6 Endocrine Disrupting Properties

The product does not include substances listed under Article 59(1) of REACH as endocrine disruptors, nor has it been identified as having endocrine-disrupting characteristics based on the criteria in Commission Delegated Regulation (EU) 2017/2100 or Commission Regulation (EU) 2018/605 at concentrations of 0.1% or above.

12.7 Other Adverse Effects No further relevant information is available.

SECTION 13: Disposal considerations

13.1 Waste Treatment Methods

Recommendation:

Empty containers may still hold hazardous residues.

Keep the label intact on the packaging until it has been properly cleaned.

Dispose of waste in accordance with national regulations.

Do not dispose of with regular household waste, and ensure the product does not enter the sewage system.



Contact manufacturer for recycling information

European waste catalogue

HP3	Flammable
HP4	Irritant - skin irritation and eye damage
HP5	Specific Target Organ Toxicity (STOT)/Aspiration Toxicity
HP6	Acute Toxicity



LAVA 20 EPDM & TPO PRIMER

Safety Data Sheet

According to Regulation (EC) No. 1907/2006 (REACH) with its Amendment Regulation (EC) No. 1272/2008 (CLP) and EU 2020/878

Printing Date 14. 12. 2023

Version Number 2 (replaces version 1)

Revision: 14. 12. 2023

Uncleaned Packaging:

Recommendation: Dispose of packaging in compliance with official regulations.

Suggested Cleaning Agents: Use water, combined with appropriate cleaning agents if needed.

SECTION 14: Transport information

14.1 UN number or ID number ADR, IMDG, IATA	UN1993
14.2 UN proper shipping name ADR IMDG, IATA	1993 FLAMMABLE LIQUID, N.O.S (XYLENES, ETHYLBENZENE) FLAMMABLE LIQUID, N.O.S. (XYLENES, ETHYLBENZENE)
14.3 Transport hazard class(es)	
ADR, IMDG, IATA  Class Label	3 Flammable liquids 3
14.4 Packing group	
ADR, IMDG, IATA	III
14.5 Environmental hazards:	Not applicable.
14.6 Special precautions for user	Warning: Flammable liquids.
Hazard identification number (Kemler code):	30
EMS Number:	F-E, <u>S-E</u>
Stowage Category	A



LAVA 20 EPDM & TPO PRIMER



Safety Data Sheet

According to Regulation (EC) No. 1907/2006 (REACH) with its Amendment Regulation (EC) No. 1272/2008 (CLP) and EU 2020/878

Printing Date 14. 12. 2023

Version Number 2 (replaces version 1)

Revision: 14. 12. 2023

14.7 Maritime transport in bulk according to IMO instruments	Not applicable.
Transport/Additional information:	
ADR Limited quantities (LQ)  Limited Quantity Marking	5L
Excepted quantities (EQ)	Code: E1 Maximum net quantity per inner packaging: 30 ml Maximum net quantity per outer packaging: 1000 ml
Transport category	3
Tunnel restriction code	D/E
IMDG Limited quantities (LQ)  Limited Quantity Marking	5L
Excepted quantities (EQ)	Code: E1 Maximum net quantity per inner packaging: 30 ml Maximum net quantity per outer packaging: 1000 ml
UN "Model Regulation":	UN 1993 FLAMMABLE LIQUID, N.O.S. (XYLENES, ETHYLBENZENE), 3, III



LAVA 20 EPDM & TPO PRIMER

Safety Data Sheet

According to Regulation (EC) No. 1907/2006 (REACH) with its Amendment Regulation (EC) No. 1272/2008 (CLP) and EU 2020/878

Printing Date 14. 12. 2023

Version Number 2 (replaces version 1)

Revision: 14. 12. 2023

SECTION 15: Regulatory information

15.1 Safety, Health, and Environmental Regulations/Legislation Specific to the Substance or Mixture

Relevant Regulations:

REACH Regulation (EC) No 1907/2006

Regulation (EU) 2020/878

CLP Regulation (EC) No 1272/2008

Directive 98/24/EC on protecting workers' health and safety from chemical risks in the workplace

Council Directive 94/33/EC on safeguarding young workers, as amended

Directive 92/85/EEC on safety and health improvements for pregnant workers, new mothers, or those breastfeeding, as amended

Directive 2012/18/EU Dangerous Substances Listing - Annex I: The substance is not listed in Annex I.

Seveso Category: P5c: Flammable Liquids

Lower-tier threshold: 5,000 tonnes

Upper-tier threshold: 50,000 tonnes

REACH Regulation (EC) No 1907/2006 - Annex XVII: Conditions of restriction: 3

Directive 2011/65/EU (RoHS) - Annex II: None of the ingredients are listed as restricted hazardous substances in electrical and electronic equipment.

Regulation (EU) 2019/1148:

Annex I - Restricted Explosives Precursors: No listed ingredients (upper limit for licensing per Article 5(3)).

Annex II - Reportable Explosives Precursors: No listed ingredients.

Drug Precursor Regulations:

Regulation (EC) No 273/2004: No listed ingredients.

Regulation (EC) No 111/2005: No listed ingredients.

National Regulations: No specific national regulations apply.

Other Restrictions: Substances of Very High Concern (SVHC) as Defined by REACH Article 57:

The product does not contain any substances identified as SVHC.

15.2 Chemical Safety Assessment A Chemical Safety Assessment has not been conducted for this

SECTION 16: Other information

The information provided reflects our current knowledge. However, it does not serve as a guarantee of specific product properties and does not create a legally binding agreement.

Relevant phrases

H225 Highly flammable liquid and vapour.

H226 Flammable liquid and vapour.

H304 May be fatal if swallowed and enters airways.

H312 Harmful in contact with skin.

H315 Causes skin irritation.

H319 Causes serious eye irritation.

H332 Harmful if inhaled.



LAVA 20 EPDM & TPO PRIMER

Safety Data Sheet

According to Regulation (EC) No. 1907/2006 (REACH) with its Amendment Regulation (EC) No. 1272/2008 (CLP) and EU 2020/878

Printing Date 14. 12. 2023

Version Number 2 (replaces version 1)

Revision: 14. 12. 2023

H335 May cause respiratory irritation.

H373 May cause damage to organs through prolonged or repeated exposure.

Classification according to Regulation (EC) No 1272/2008

Flammable liquids	Bridging principles
Acute toxicity - dermal Acute toxicity - inhalation Skin corrosion/irritation Serious eye damage/irritation Specific target organ toxicity (single exposure) Specific target organ toxicity (repeated exposure)	The classification of the mixture is generally based on the calculation method using substance data according to Regulation (EC) No 1272/2008.
Aspiration hazard	Expert judgement

Version number of previous version: 1

Abbreviations and acronyms:

ADR: Accord relatif au transport international des marchandises dangereuses par route (European Agreement Concerning the International Carriage of Dangerous Goods by Road)

IMDG: International Maritime Code for Dangerous Goods

IATA: International Air Transport Association

GHS: Globally Harmonised System of Classification and Labelling of Chemicals

EINECS: European Inventory of Existing Commercial Chemical Substances

ELINCS: European List of Notified Chemical Substances

CAS: Chemical Abstracts Service (division of the American Chemical Society)

VOC: Volatile Organic Compounds (USA, EU)

DNEL: Derived No-Effect Level (REACH)

PNEC: Predicted No-Effect Concentration (REACH)

LC50: Lethal concentration, 50 percent

LD50: Lethal dose, 50 percent

PBT: Persistent, Bioaccumulative and Toxic

SVHC: Substances of Very High Concern

vPvB: very Persistent and very Bioaccumulative

ATE: Acute toxicity estimate values

Flam. Liq. 2: Flammable liquids – Category 2

Flam. Liq. 3: Flammable liquids – Category 3

Acute Tox. 4: Acute toxicity – Category 4

Skin Irrit. 2: Skin corrosion/irritation – Category 2

Eye Irrit. 2: Serious eye damage/eye irritation – Category 2

STOT SE 3: Specific target organ toxicity (single exposure) – Category 3

STOT RE 2: Specific target organ toxicity (repeated exposure) – Category 2

Asp. Tox. 1: Aspiration hazard – Category 1

* Data compared to the previous version altered.



OWL UNIVERSAL 2 PART EPOXY PRIMER (PART A)

Safety Data Sheet

According to Regulation (EC) No. 1907/2006 (REACH) with its Amendment Regulation (EC) No. 1272/2008 (CLP) and EU 2020/878

Printing Date 17. 09. 2025

Version Number 01

Revision: 17. 09. 2025

SECTION 1: Identification of the substance/mixture and of the company/undertaking

1.1 Product identifier

Trade name: Owl Universal 2 Part Epoxy Primer (Part A)

1.2 Relevant identified uses of the substance or mixture and uses advised against Professional Use

Application of the substance / the mixture: Epoxy Primer

1.3 Details of the supplier of the safety data sheet

Manufacturer/Supplier:

OWL WATERPROOFING SOLUTIONS

135 Slaney Road, Dublin Industrial Estate

Glasnevin, Dublin 11

Tel: +353 01 830 2250

Email: info@owlwaterproofing.co.uk

Website: www.owlwaterproofing.co.uk

1.4 Emergency telephone number:

European Emergency Tel.: +353 01 830 2250

SECTION 2: Hazards identification

2.1 Substance or Mixture Classification

Classification as per Regulation (EC) No 1272/2008 (CLP):

GHS05 corrosion



Eye Dam 1: H318 Causes serious eye damage.

2.2 Label Elements

Labelling in Accordance with Regulation (EC) No 1272/2008 (CLP): Classified and labelled according to the CLP regulation.

Hazard Pictograms: GHS05



Signal Word: None

Label Hazard Components: Linseed oil polymer with bisphenol A, bisphenol A diglycidyl ether, diethylenetriamine, formaldehyde, glycidyl phenyl ether, and pentaethylenehexamine.

Hazard Statements: H318 Causes serious eye damage.

Precautionary Measures

P264: Ensure thorough handwashing after handling.

P280: Use appropriate protective gloves, clothing, and safety gear for eyes, face, and hearing.

P305+P351+P338: If eye contact occurs, rinse carefully with water for several minutes. Remove contact lenses if present and easy to do, then continue rinsing.



OWL UNIVERSAL 2 PART EPOXY PRIMER (PART A)

Safety Data Sheet

According to Regulation (EC) No. 1907/2006 (REACH) with its Amendment Regulation (EC) No. 1272/2008 (CLP) and EU 2020/878

Printing Date 17. 09. 2025

Version Number 01

Revision: 17. 09. 2025

P310: Seek immediate assistance from a doctor or poison control center.

P337+P313: If eye irritation continues, obtain medical advice or attention.

P501: Dispose of product and packaging according to applicable local, regional, national, or international regulations.

2.3 Additional Information

PBT/vPvB Assessment: This product contains no substances classified as persistent, bioaccumulative, and toxic (PBT) or as very persistent and very bioaccumulative (vPvB) at levels of 0.1% or above.

Endocrine-Disrupting Properties: No ingredients in this product are listed under Article 59(1) of REACH or identified under EU Regulations 2017/2100 or 2018/605 as endocrine disruptors at concentrations $\geq 0.1\%$.

SECTION 3: Composition/information on ingredients

Description: Ingredients according to Regulation (EU) 2020/878

CAS: 68915-81-1 EC number: 639-495-9	Linseed oil polymer with bisphenol A, bisphenol A diglycidyl ether, diethylenetriamine, formaldehyde, glycidyl Ph ether and pentaethylenehexamine Eye Dam. 1, H318; Skin Irrit. 2, H315	≥ 3 - $<10\%$
---	--	--------------------

SVHC: This product contains no substances of very high concern (SVHC) at concentrations $\geq 0.1\%$, as defined under REACH Regulation (EC) No 1907/2006, Article 59.

SECTION 4: First aid measures

4.1 General Advice

Move affected individuals to fresh air immediately and seek medical assistance.

Inhalation

Ensure access to fresh air and contact a doctor.

If the person is unconscious, place them in the recovery position for transport.

Skin Contact

Wash thoroughly with soap and water.

Seek medical attention if irritation persists.

Eye Contact

Rinse eyes with plenty of water for at least 15 minutes, lifting upper and lower eyelids.

Remove contact lenses if present and easy to do.

Avoid strong water jets to prevent corneal damage.

Get medical advice if irritation continues.

Ingestion

Do not induce vomiting.

Drink plenty of water, provide fresh air, and seek immediate medical help.



OWL UNIVERSAL 2 PART EPOXY PRIMER (PART A)

Safety Data Sheet

According to Regulation (EC) No. 1907/2006 (REACH) with its Amendment Regulation (EC) No. 1272/2008 (CLP) and EU 2020/878

Printing Date 17. 09. 2025

Version Number 01

Revision: 17. 09. 2025

Show the product label or SDS to medical personnel.

4.2 Symptoms Acute and Delayed No additional information available.

4.3 Special Treatment No specific measures known.

SECTION 5: Firefighting measures

5.1 Suitable Extinguishing Media

Use CO₂, dry powder, or water spray.

Avoid high-pressure water jets.

5.2 Special Hazards

Fire may produce carbon monoxide (CO) and carbon dioxide (CO₂).

5.3 Firefighting Instructions

Wear appropriate respiratory protection and full protective gear.

Collect firefighting water separately; prevent it from entering drains or waterways.

SECTION 6: Accidental release measures

6.1 Personal Precautions

Use protective clothing and equipment; restrict access to unauthorized personnel.

Avoid inhaling vapors and eliminate all ignition sources.

Non-Emergency Personnel

Prevent contact with leaking or spilled material.

Emergency Responders

First-aid personnel should wear protective suits, gloves, goggles, and a respirator with an A-type filter.

6.2 Environmental Precautions

Prevent entry into drains, surface water, or groundwater.

6.3 Containment and Cleanup

Absorb spills using sand, diatomaceous earth, or similar inert materials.

6.4 Additional References

See Section 7 for handling procedures.

See Section 8 for personal protection measures.

See Section 13 for disposal guidelines.

SECTION 7: Handling and storage

7.1 Safe Handling

Provide adequate ventilation at the workplace.

Avoid contact with skin and eyes.

Do not eat, drink, or smoke while handling the product.

Wash hands thoroughly after use and launder contaminated clothing before reuse.

Keep away from heat sources, sparks, open flames, and hot surfaces.

7.2 Storage Conditions

Store in tightly sealed containers in cool, well-ventilated areas.

Protect from heat, sunlight, and moisture.



OWL UNIVERSAL 2 PART EPOXY PRIMER (PART A)

Safety Data Sheet

According to Regulation (EC) No. 1907/2006 (REACH) with its Amendment Regulation (EC) No. 1272/2008 (CLP) and EU 2020/878

Printing Date 17. 09. 2025

Version Number 01

Revision: 17. 09. 2025

7.3 Specific End Use(s)

No additional information available.

SECTION 8: Exposure Controls / Personal Protection

8.1 Control Parameters

The product contains no substances requiring workplace exposure monitoring.

8.2 Exposure Controls

Engineering Controls

Ensure adequate ventilation in all work areas.

Personal Protective Measures

Keep away from food, drinks, and animal feed.

Wash hands before breaks and after handling.

Avoid eye and skin contact; do not inhale vapors or mists.

Do not eat, drink, or smoke while using this product.

Remove and wash contaminated clothing before reuse.

Respiratory Protection

Use appropriate respiratory protection where ventilation is insufficient.

For spraying or enclosed areas, use air-fed masks or A2-P2 filters (EN529).



Hand Protection

Wear chemical-resistant gloves (EN 374-1). Recommended materials:

- Butyl rubber (IIR): ≥ 0.5 mm thickness; ≥ 480 min breakthrough time
- Fluorinated rubber (FKM): ≥ 0.4 mm thickness; ≥ 480 min breakthrough time



Follow manufacturer guidelines and replace gloves if damaged or contaminated.

For safety, limit glove usage to 50% of the tested breakthrough time.

Eye and Face Protection

Wear safety glasses with side shields or protective goggles (EN 166).



Body Protection

Use chemical-resistant clothing (EN 14605) and protective boots.



SECTION 9: Physical and chemical properties

9.1 Primary physical and chemical properties

Physical state	Liquid
Colour:	Opaque
Odour:	Not determined
Melting point:	Not determined



OWL UNIVERSAL 2 PART EPOXY PRIMER (PART A)

Safety Data Sheet

According to Regulation (EC) No. 1907/2006 (REACH) with its Amendment Regulation (EC) No. 1272/2008 (CLP) and EU 2020/878

Printing Date 17. 09. 2025

Version Number 01

Revision: 17. 09. 2025

Lower and upper explosion limit Lower: Upper:	Not determined Not determined
Auto ignition temperature	Not determined
Decomposition temperature	Not determined
Solubility in Water:	Not soluble
PH	Not determined
Viscosity Kinematic viscosity: Dynamic (20°C):	Not determined 40mPas
Partition coefficient n-octanol/ water (log value)	Not determined
Vapour pressure Density and/or relative density Density (20°C):	1.1 g/cm³
Relative density	Not determined
Vapour density	Not determined
Flash point	Not flammable
Flammable	Not determined

9.2 Other Information No further relevant information available.

Form: Liquid

Ignition Temperature: Not self-igniting

Explosion Hazard: None

VOC (EC): 30 g/l



OWL UNIVERSAL 2 PART EPOXY PRIMER (PART A)

Safety Data Sheet

According to Regulation (EC) No. 1907/2006 (REACH) with its Amendment Regulation (EC) No. 1272/2008 (CLP) and EU 2020/878

Printing Date 17. 09. 2025

Version Number 01

Revision: 17. 09. 2025

Oxidising Properties: None

Evaporation Rate: Not determined

Physical Hazards: None applicable (flammable, oxidising, explosive, pyrophoric, self-heating, corrosive, etc.)

SECTION 10: Stability and reactivity

Reactivity: No data available

Stability: Stable under normal conditions; avoid excessive heat

Hazardous Reactions: None identified

Avoid: Heat, sparks, flames, ignition sources

Incompatibilities: Not specified

Decomposition Products: CO, CO₂

SECTION 11: Toxicological information

Acute Toxicity: Does not meet classification criteria.

- Oral LD50 (rat): 2960 mg/kg
- Dermal LD50 (rabbit): >5000 mg/kg

Skin Corrosion/Irritation: Not classified.

Eye Damage/Irritation: Causes serious eye damage.

Respiratory/Skin Sensitisation: Not classified.

Mutagenicity, Carcinogenicity, Reproductive Toxicity: Not classified.

STOT (Single/Repeated Exposure): Not classified.

Aspiration Hazard: Not classified.

Repeated Dose Toxicity: Not classified.

Endocrine Disruption: No substances identified as endocrine disruptors $\geq 0.1\%$.

SECTION 12: Ecological information

Aquatic Toxicity: No data available.

Persistence & Degradability: No data available.

Bioaccumulation Potential: No data available.

Mobility in Soil: No data available.

PBT/vPvB Assessment: No ingredients identified as PBT or vPvB $\geq 0.1\%$ (REACH Annex XIII).

Endocrine Disruption: No substances identified as endocrine disruptors $\geq 0.1\%$ (EU Regulations 2017/2100, 2018/605).

Other Effects: Undiluted product should not enter drains or watercourses.

SECTION 13: Disposal considerations

Waste Treatment: Dispose of contents in accordance with national and local regulations.

Restrictions: Do not dispose of with household waste or release into sewage systems.

Recycling: Contact manufacturer for recycling guidance.

Packaging: Dispose of uncleaned containers per official regulations.





OWL UNIVERSAL 2 PART EPOXY PRIMER (PART A)

Safety Data Sheet

According to Regulation (EC) No. 1907/2006 (REACH) with its Amendment Regulation (EC) No. 1272/2008 (CLP) and EU 2020/878

Printing Date 17. 09. 2025

Version Number 01

Revision: 17. 09. 2025

SECTION 14: Transport information

UN number or ID number ADR, ADN, IMDG, IATA	Not applicable; not classified as dangerous for transport.
UN proper shipping name ADR, ADN, IMDG, IATA	Void
Transport hazard class(es) ADR, ADN, IMDG, IATA Class	Void
Packing group ADR, IMDG, IATA	Void
Environmental Hazards	Not a marine pollutant.
Special Precautions	Not required.
Bulk Transport (IMO)	Not applicable.
UN Model Regulation	Not applicable.

SECTION 15: Regulatory information

15.1 Safety, Health & Environmental Legislation

Complies with:

Packaging Waste Directive 94/62/EC

REACH Regulation (EC) 1907/2006

CLP Regulation (EC) 1272/2008

Regulation (EU) 2020/878

Directive 98/24/EC (Worker Protection)

Directive 94/33/EC (Young Workers)

Directive 92/85/EEC (Pregnant/Breastfeeding Workers)

Directive 2012/18/EU (Major Accident Hazards)

Directive 2011/65/EU (Hazardous Substances in Electronics)



OWL UNIVERSAL 2 PART EPOXY PRIMER (PART A)

Safety Data Sheet

According to Regulation (EC) No. 1907/2006 (REACH) with its Amendment Regulation (EC) No. 1272/2008 (CLP) and EU 2020/878

Printing Date 17. 09. 2025

Version Number 01

Revision: 17. 09. 2025

No substances listed under:

REACH Annex I or XVII restrictions

Regulation (EU) 2019/1148 (Explosives Precursors)

Regulation (EC) 273/2004 & 111/2005 (Drug Precursors)

Contains no SVHC (Substances of Very High Concern).

15.2 Chemical Safety Assessment Not performed.

SECTION 16: Other information

The information provided here reflects our current understanding. It does not serve as a guarantee of specific product properties, nor does it create a legally binding agreement.

H315: May cause skin irritation

H318: May cause severe eye damage

Classification (EC No 1272/2008): Mixture classification for eye irritation is determined using the calculation method under Regulation (EC) No 1272/2008.

Department issuing SDS:



OWL WATERPROOFING SOLUTIONS

135 Slaney Road, Dublin Industrial Estate

Glasnevin, Dublin 11

Tel: +353 01 830 2250

Email: info@owlwaterproofing.co.uk

Website: www.owlwaterproofing.co.uk

Version number of previous version: 0

Abbreviations and acronyms:

ADR: Accord relatif au transport international des marchandises dangereuses par route (European Agreement Concerning the International Carriage of Dangerous Goods by Road)

IMDG: International Maritime Code for Dangerous Goods

IATA: International Air Transport Association

GHS: Globally Harmonised System of Classification and Labelling of Chemicals

EINECS: European Inventory of Existing Commercial Chemical Substances

ELINCS: European List of Notified Chemical Substances

CAS: Chemical Abstracts Service (division of the American Chemical Society)

VOC: Volatile Organic Compounds (USA, EU)

LC50: Lethal concentration, 50 percent

LD50: Lethal dose, 50 percent

PBT: Persistent, Bioaccumulative and Toxic

SVHC: Substances of Very High Concern

vPvB: very Persistent and very Bioaccumulative

Skin Irrit. 2: Skin corrosion/irritation – Category 2

Eye Dam. 1: Serious eye damage/eye irritation – Category 1

***Data compared to the previous version altered.**



OWL UNIVERSAL 2 PART EPOXY PRIMER (PART B)

Safety Data Sheet

According to Regulation (EC) No. 1907/2006 (REACH) with its
Amendment Regulation (EC) No. 1272/2008 (CLP) and EU 2020/878

Printing Date 17. 09. 2025

Version Number 01

Revision: 17. 09. 2025

SECTION 1: Identification of the substance/mixture and of the company/undertaking

1.1 Product identifier

Trade name: Owl Universal 2 Part Epoxy Primer (Part B)

1.2 Relevant identified uses of the substance or mixture and uses advised against Professional Use

Application of the substance / the mixture: Epoxy Primer

1.3 Details of the supplier of the safety data sheet

Manufacturer/Supplier:

OWL WATERPROOFING SOLUTIONS

135 Slaney Road, Dublin Industrial Estate

Glasnevin, Dublin 11

Tel: +353 01 830 2250

Email: info@owlwaterproofing.co.uk

Website: www.owlwaterproofing.co.uk

1.4 Emergency telephone number:

European Emergency Tel.: +353 01 830 2250

SECTION 2: Hazards identification

2.1 Substance or Mixture Classification

Classification as per Regulation (EC) No 1272/2008 (CLP):

GHS08 health hazard



Muta. 2 (H341): Suspected of causing genetic defects.

GHS09 environment



Aquatic Chronic 2 (H411): Toxic to aquatic life with long-lasting effects.

GHS07



Skin Irrit. 2 (H315): Causes skin irritation.

Eye Irrit. 2 (H319): Causes serious eye irritation.

Skin Sens. 1 (H317): May cause an allergic skin reaction.

2.2 Label Elements

Labelling in Accordance with Regulation (EC) No 1272/2008 (CLP): Classified and labelled according to the CLP regulation.

Hazard Pictograms: GHS07 GHS08 GHS09





OWL UNIVERSAL 2 PART EPOXY PRIMER (PART B)

Safety Data Sheet

According to Regulation (EC) No. 1907/2006 (REACH) with its Amendment Regulation (EC) No. 1272/2008 (CLP) and EU 2020/878

Printing Date 17. 09. 2025

Version Number 01

Revision: 17. 09. 2025

Signal Word: Warning

Label Components:

2,3-epoxypropyl o-tolyl ether

2,2'-[(1-methylethylidene)bis(4,1-phenyleneoxymethylene)]bisoxirane

Hazard Statements:

H315: Causes skin irritation

H319: Causes serious eye irritation

H317: May cause an allergic skin reaction

H341: Suspected of causing genetic defects

H411: Toxic to aquatic life with long-lasting effects

Precautionary Measures:

P261: Avoid inhaling vapours or sprays

P273: Prevent release to the environment

P280: Wear suitable protective gloves, clothing, and eye/face protection

P302+P352: IF ON SKIN: Wash thoroughly with soap and water

P305+P351+P338: IF IN EYES: Rinse carefully with water, remove contact lenses if easy to do, continue rinsing

P501: Dispose of product and packaging according to local/national regulations

Additional Info:

EUH205: Contains epoxy components. May cause allergic reactions.

PBT/vPvB: No substances identified at $\geq 0.1\%$.

Endocrine Disruption: No substances identified at $\geq 0.1\%$.

SECTION 3: Composition/information on ingredients

Description: Ingredients according to Regulation (EU) 2020/878

<p>CAS: 1675-54-3 EINECS: 216-823-5 Index number: 603-073-00-2 Reg.nr.: 01-2119456619-26-XXXX</p>	<p>2,2'-[(1-methylethylidene)bis(4,1-phenyleneoxymethylene)]bisoxirane Aquatic Chronic 2, H411; Skin Irrit. 2, H315; Eye Irrit. 2, H319; Skin Sens. 1, H317 Specific concentration limits: Eye Irrit. 2; H319: C $\geq 5\%$ Skin Irrit. 2; H315: C $\geq 5\%$</p>	<p>50%</p>
<p>CAS: 2210-79-9 EINECS: 218-645-3 Index number: 603-056-00-X Reg.nr.: 01-2119966907-18-XXXX</p>	<p>2,3-epoxypropyl o-tolyl ether Muta. 2, H341; Aquatic Chronic 2, H411; Skin Irrit. 2, H315; Skin Sens. 1, H317</p>	<p>50%</p>



OWL UNIVERSAL 2 PART EPOXY PRIMER (PART B)

Safety Data Sheet

According to Regulation (EC) No. 1907/2006 (REACH) with its Amendment Regulation (EC) No. 1272/2008 (CLP) and EU 2020/878

Printing Date 17. 09. 2025

Version Number 01

Revision: 17. 09. 2025

SVHC: This product contains no substances of very high concern (SVHC) at concentrations $\geq 0.1\%$ as defined in REACH Regulation (EC) No 1907/2006, Article 59.

SECTION 4: First aid measures

4.1 General Advice

Move affected persons to fresh air and seek medical attention immediately.

Inhalation

Provide fresh air and consult a doctor if symptoms occur.

If unconscious, place in the recovery position for transport.

Skin Contact

Wash thoroughly with soap and water.

If irritation persists, seek medical attention.

Eye Contact

Rinse eyes with plenty of water for at least 15 minutes, lifting eyelids occasionally.

Remove contact lenses if present and easy to do.

Avoid high-pressure water jets to prevent corneal damage.

Seek medical advice if irritation continues.

Ingestion

Do not induce vomiting.

Drink water, move to fresh air, and call for medical help immediately.

Provide product label or SDS to medical personnel.

4.2 Symptoms No additional information available.

4.3 Special Treatment No specific treatment known.

SECTION 5: Firefighting measures

5.1 Suitable Extinguishing Media

Use CO₂, dry powder, or water spray.

Avoid high-pressure water jets.

5.2 Special Hazards

Fire may produce carbon monoxide (CO) and carbon dioxide (CO₂).

5.3 Firefighting Instructions

Wear appropriate respiratory protection and full protective gear.

Collect firefighting water separately; prevent it from entering drains or waterways.

SECTION 6: Accidental release measures

6.1 Personal Precautions

Use protective clothing and equipment; restrict access to unauthorized personnel.

Avoid inhaling vapors and eliminate all ignition sources.

Non-Emergency Personnel

Prevent contact with leaking or spilled material.

Emergency Responders

Wear protective clothing, gloves, goggles, and a respirator with filter type A.

6.2 Environmental Precautions

Prevent entry into drains, surface water, or groundwater.



OWL UNIVERSAL 2 PART EPOXY PRIMER (PART B)

Safety Data Sheet

According to Regulation (EC) No. 1907/2006 (REACH) with its Amendment Regulation (EC) No. 1272/2008 (CLP) and EU 2020/878

Printing Date 17. 09. 2025

Version Number 01

Revision: 17. 09. 2025

6.3 Containment and Cleanup

Absorb spills using sand, diatomaceous earth, or similar inert materials.

6.4 Additional References

See Section 7 for handling procedures.

See Section 8 for personal protection measures.

See Section 13 for disposal guidelines.

SECTION 7: Handling and storage

7.1 Safe Handling

Provide adequate ventilation at the workplace.

Avoid contact with skin and eyes.

Do not eat, drink, or smoke while handling the product.

Wash hands thoroughly after use and launder contaminated clothing before reuse.

Keep away from heat sources, sparks, open flames, and hot surfaces.

7.2 Storage Conditions

Store in tightly sealed containers in cool, well-ventilated areas.

Protect from heat, sunlight, and moisture.

7.3 Specific End Use(s)

No additional information available.

SECTION 8: Exposure Controls / Personal Protection

8.1 Control Parameters

The product contains no substances requiring workplace exposure monitoring.

8.2 Exposure Controls

Engineering Controls

Ensure adequate ventilation in all work areas.

Personal Protective Measures

Keep away from food, drinks, and animal feed.

Wash hands before breaks and after handling.

Avoid eye and skin contact; do not inhale vapors or mists.

Do not eat, drink, or smoke while using this product.

Remove and wash contaminated clothing before reuse.

Respiratory Protection

Use appropriate respiratory protection where ventilation is insufficient.

For spraying or enclosed areas, use air-fed masks or A2-P2 filters (EN529).



Hand Protection

Wear chemical-resistant gloves (EN 374-1). Recommended materials:

- Butyl rubber (IIR): ≥ 0.5 mm thickness; ≥ 480 min breakthrough time
- Fluorinated rubber (FKM): ≥ 0.4 mm thickness; ≥ 480 min breakthrough time

Follow manufacturer guidelines and replace gloves if damaged or contaminated.

For safety, limit glove usage to 50% of the tested breakthrough time.





OWL UNIVERSAL 2 PART EPOXY PRIMER (PART B)

Safety Data Sheet

According to Regulation (EC) No. 1907/2006 (REACH) with its Amendment Regulation (EC) No. 1272/2008 (CLP) and EU 2020/878

Printing Date 17. 09. 2025

Version Number 01

Revision: 17. 09. 2025

Eye and Face Protection

Wear safety glasses with side shields or protective goggles (EN 166).



Body Protection

Use chemical-resistant clothing (EN 14605) and protective boots.



SECTION 9: Physical and chemical properties

9.1 Primary physical and chemical properties

Physical state	Liquid
Colour:	Opaque
Odour:	Not determined
Melting point:	<-15 °C
Flammable	Not determined
Lower and upper explosion limit Lower: Upper:	Not determined Not determined
Auto-ignition temperature:	320 °C
Decomposition temperature:	Not determined
pH	Not determined
Viscosity: Kinematic viscosity Dynamic (20 °C)	Not determined 500-700 mPas
Solubility water:	Insoluble
Partition coefficient n-octanol/water (log value)	Not determined



OWL UNIVERSAL 2 PART EPOXY PRIMER (PART B)

Safety Data Sheet

According to Regulation (EC) No. 1907/2006 (REACH) with its Amendment Regulation (EC) No. 1272/2008 (CLP) and EU 2020/878

Printing Date 17. 09. 2025

Version Number 01

Revision: 17. 09. 2025

Vapour pressure	Not determined
Density and/or relative density Density (20°C):	1.14 g/cm ³
Relative density	Not determined
Vapour density	Not determined

9.2 Other Information No further relevant information available.

Form: Liquid

Ignition Temperature: Not self-igniting

Explosion Hazard: None

VOC (EC): 30 g/l

Oxidising Properties: None

Evaporation Rate: Not determined

Physical Hazards: None applicable (flammable, oxidising, explosive, pyrophoric, self-heating, corrosive, etc.)

SECTION 10: Stability and reactivity

Reactivity: No data available

Stability: Stable under normal conditions; avoid excessive heat

Hazardous Reactions: None identified

Avoid: Heat, sparks, flames, ignition sources

Incompatibilities: Not specified

Decomposition Products: CO, CO₂

SECTION 11: Toxicological information

Acute Toxicity: Does not meet classification criteria.

- Oral LD50 (rat): >2000 mg/kg
- Dermal LD50 (rabbit): >2000 mg/kg

Skin Corrosion/Irritation: Causes skin irritation

Eye Damage/Irritation: Causes serious eye damage.

Respiratory/Skin Sensitisation: May cause an allergic skin reaction

Mutagenicity: Category 2 (Muta. 2)

Carcinogenicity, Reproductive Toxicity, STOT (Single/Repeated Exposure), Aspiration Hazard: Not classified.

Repeated Dose Toxicity: Not classified.

Endocrine Disruption: No substances identified as endocrine disruptors $\geq 0.1\%$. (REACH Article 59, EU Regulations 2017/2100, 2018/605).



OWL UNIVERSAL 2 PART EPOXY PRIMER (PART B)

Safety Data Sheet

According to Regulation (EC) No. 1907/2006 (REACH) with its Amendment Regulation (EC) No. 1272/2008 (CLP) and EU 2020/878

Printing Date 17. 09. 2025

Version Number 01

Revision: 17. 09. 2025

SECTION 12: Ecological information

Aquatic Toxicity (CAS 1675-54-3):

EC50 (48h, Daphnia): 1.8 mg/l

EC50 (72h, Algae): 9.4 mg/l

EC50 (96h, Leuciscus idus): 2 mg/l

NOEC (21d, Daphnia): 0.3 mg/l

Harmful to fish, plankton, and aquatic organisms.

Persistence & Degradability: No data available.

Bioaccumulative Potential: No data available.

Mobility in Soil: No data available.

PBT/vPvB: Not applicable.

Endocrine Disruption: No substances identified $\geq 0.1\%$ (REACH, EU Regulations 2017/2100, 2018/605).

Other Effects: Toxic to aquatic life.

SECTION 13: Disposal considerations

Waste Treatment: Dispose of contents in accordance with national and local regulations.

Restrictions: Do not dispose of with household waste or release into sewage systems.

Recycling: Contact manufacturer for recycling guidance.

European Waste Catalogue Codes:

HP4: Irritant – causes skin and eye irritation

HP11: Mutagenic

HP13: Sensitising

HP14: Ecotoxic

Packaging: Dispose of uncleaned containers per official regulations.



SECTION 14: Transport information

UN number or ID number ADR, IMDG, IATA	UN3082
UN proper shipping name ADR IMDG	3082 ENVIRONMENTALLY HAZARDOUS SUBSTANCE, LIQUID, N.O.S. (2,3-epoxypropyl otolyl ether, 2,2'-[(1-methylethylidene)bis(4,1-phenyleneoxymethylene)]bisoxirane) ENVIRONMENTALLY HAZARDOUS SUBSTANCE, LIQUID, N.O.S. (2,3-epoxypropyl o-tolyl ether, 2,2'-[(1-methylethylidene)bis(4,1-phenyleneoxymethylene)]bisoxirane), MARINE POLLUTANT



OWL UNIVERSAL 2 PART EPOXY PRIMER (PART B)



Safety Data Sheet

According to Regulation (EC) No. 1907/2006 (REACH) with its Amendment Regulation (EC) No. 1272/2008 (CLP) and EU 2020/878

Printing Date 17. 09. 2025

Version Number 01

Revision: 17. 09. 2025

IATA	ENVIRONMENTALLY HAZARDOUS SUBSTANCE, LIQUID, N.O.S. (2,3-epoxypropyl o-tolyl ether, 2,2'-[(1-methylethylidene)bis(4,1-phenyleneoxymethylene)] bisoxirane)
Transport Hazard Class:  	Class 9 – Miscellaneous dangerous substances (Label 9)
Packing group ADR, IMDG, IATA	III
Environmental Hazards	Marine pollutant – Yes (Fish & Tree symbol)
Special Precautions	Warning – Miscellaneous dangerous substances; Kemler code 90; EMS F-A, S-F; Stowage Category A
ADR/IMDG Limitations:	LQ 5L; EQ Code E1 (Max 30 ml inner, 1000 ml outer packaging); Transport category 3
UN "Model Regulation":	UN 3082 ENVIRONMENTALLY HAZARDOUS SUBSTANCE, LIQUID, N.O.S. (2,3-EPOXYPROPYL O-TOLYL ETHER, 2,2'-[(1-METHYLETHYLIDENE) BIS(4,1-PHENYLENEOXYMETHYLENE)] BISOXIRANE), 9, III
Bulk Transport (IMO):	Not applicable.

SECTION 15: Regulatory information

15.1 Safety, Health & Environmental Legislation

Complies with:

REACH Regulation (EC) 1907/2006

Regulation (EU) 2020/878

CLP Regulation (EC) 1272/2008

Directive 98/24/EC – Worker Protection

Directive 94/62/EC – Packaging Waste



OWL UNIVERSAL 2 PART EPOXY PRIMER (PART B)

Safety Data Sheet

According to Regulation (EC) No. 1907/2006 (REACH) with its Amendment Regulation (EC) No. 1272/2008 (CLP) and EU 2020/878

Printing Date 17. 09. 2025

Version Number 01

Revision: 17. 09. 2025

Directive 92/85/EEC – Pregnant & Breastfeeding Workers

Directive 2012/18/EU – Seveso III (Aquatic Environment, Category E2)

Directive 2011/65/EU – Hazardous Substances in Electronics

Seveso III Thresholds:

Lower-tier: 200 t

Upper-tier: 500 t

Annexes & Listings:

No substances listed under REACH Annex I, XVII, EU 2019/1148, EC 273/2004, or EC 111/2005.

No SVHC substances (REACH Article 57).

15.2 Chemical Safety Assessment Not performed.

SECTION 16: Other information

The information provided here reflects our current understanding. It does not serve as a guarantee of specific product properties, nor does it create a legally binding agreement.

H315: May cause skin irritation

H317 May cause an allergic skin reaction.

H319 Causes serious eye irritation.

H341 Suspected of causing genetic defects.

H411 Toxic to aquatic life with long lasting effects.

Classification (EC No 1272/2008): Classification is based on the calculation method using substance data in accordance with Regulation (EC) No 1272/2008.

Skin irritation/corrosion

Serious eye damage/irritation

Skin sensitisation

Germ cell mutagenicity

Chronic aquatic toxicity

Department issuing SDS:



OWL WATERPROOFING SOLUTIONS

135 Slaney Road, Dublin Industrial Estate

Glasnevin, Dublin 11

Tel: +353 01 830 2250

Email: info@owlwaterproofing.co.uk

Website: www.owlwaterproofing.co.uk

Version number of previous version: 0

Abbreviations and acronyms:

ADR: Accord relatif au transport international des marchandises dangereuses par route (European Agreement Concerning the International Carriage of Dangerous Goods by Road)

IMDG: International Maritime Code for Dangerous Goods

IATA: International Air Transport Association

GHS: Globally Harmonised System of Classification and Labelling of Chemicals

EINECS: European Inventory of Existing Commercial Chemical Substances



OWL UNIVERSAL 2 PART EPOXY PRIMER (PART B)

Safety Data Sheet

According to Regulation (EC) No. 1907/2006 (REACH) with its
Amendment Regulation (EC) No. 1272/2008 (CLP) and EU 2020/878

Printing Date 17. 09. 2025

Version Number 01

Revision: 17. 09. 2025

ELINCS: European List of Notified Chemical Substances

CAS: Chemical Abstracts Service (division of the American Chemical Society)

VOC: Volatile Organic Compounds (USA, EU)

LC50: Lethal concentration, 50 percent

LD50: Lethal dose, 50 percent

PBT: Persistent, Bioaccumulative and Toxic

SVHC: Substances of Very High Concern

vPvB: very Persistent and very Bioaccumulative

Skin Irrit. 2: Skin corrosion/irritation – Category 2

Eye Irrit. 2: Serious eye damage/eye irritation – Category 2

Skin Sens. 1: Skin sensitisation – Category 1

Muta. 2: Germ cell mutagenicity – Category 2

Aquatic Chronic 2: Hazardous to the aquatic environment - long-term aquatic hazard – Category 2

*** Data compared to the previous version altered.**



LAVA 20 CHOPPED STRAND MATTING

Safety Data Sheet

According to Regulation (EC) No. 1907/2006 (REACH) with its Amendment Regulation (EC) No. 1272/2008 (CLP) and EU 2020/878

Printing Date 16. 09. 2025

Version Number 3 (replaces version 2)

Revision: 16. 09. 2025

SECTION 1: Identification of the substance/mixture and of the company/undertaking

1.1 Product identifier

Trade name: LAVA 20 CHOPPED STRAND MATTING

Composition: Low Alkali, Borosilicate Glass fiber in an amorphous vitreous state, with an organic polymer size

1.2 Relevant identified uses of the substance or mixture and uses advised against

No further relevant information available.

Application of the substance / the mixture: Emulsion and Powder based fiberglass matting designed to reinforce Lava 20 liquid-applied waterproofing membranes.

1.3 Details of the supplier of the safety data sheet

Manufacturer/Supplier:

OWL WATERPROOFING SOLUTIONS

135 Slaney Road, Dublin Industrial Estate

Glasnevin, Dublin 11

Tel: +353 01 830 2250

Email: info@owlwaterproofing.co.uk

Website: www.owlwaterproofing.co.uk

1.4 Emergency telephone number:

European Emergency Tel.: +353 01 830 2250

SECTION 2: Hazards identification

2.1 Substance or Mixture Classification

Classification as per Regulation (EC) No 1272/2008 (CLP): The substance is not classified under the CLP regulation.

2.2 Label Elements

Labelling in Accordance with Regulation (EC) No 1272/2008 (CLP): Not applicable.

Hazard Pictograms: None

Signal Word: None

Hazard Statements: None

2.3 Additional Hazards

PBT and vPvB Assessment:

This product does not contain any components classified as persistent, bioaccumulative, and toxic (PBT) or as very persistent and very bioaccumulative (vPvB).

PBT: Not applicable

vPvB: Not applicable

Assessment of Endocrine-Disrupting Properties:

The product does not include substances listed under Article 59(1) of REACH for endocrine-disrupting effects, nor has it been identified as having such properties according to the criteria set out in Commission Delegated Regulation (EU) 2017/2100 or Commission Regulation (EU) 2018/605 at levels of 0.1% or higher.



LAVA 20 CHOPPED STRAND MATTING

Safety Data Sheet

According to Regulation (EC) No. 1907/2006 (REACH) with its Amendment Regulation (EC) No. 1272/2008 (CLP) and EU 2020/878

Printing Date 16. 09. 2025

Version Number 3 (replaces version 2)

Revision: 16. 09. 2025

SECTION 3: Composition/information on ingredients

3.1 Security: Classified as non-hazardous under EC legislation (Reinforced fiberglass).

3.2 Main Hazards: Prolonged or repeated dust exposure without respiratory protection may affect breathing.

SECTION 4: First aid measures

4.1 Description

General Advice:

Move the affected individual to an area with fresh air.

Seek prompt medical attention.

If Inhaled:

Ensure the person has access to fresh air and call a doctor for further assistance.

If the person is unconscious, position them on their side for safe transportation.

Skin Contact:

Wash the affected area immediately with soap and water, and rinse thoroughly.

If irritation persists, seek medical advice.

If in Eyes:

Rinse eyes thoroughly with water, gently lifting both the upper and lower eyelids.

Remove contact lenses if present.

Continue rinsing for at least 15 minutes.

Seek medical care if irritation continues.

If Swallowed:

Have the person drink plenty of water and ensure access to fresh air. Contact a doctor immediately.

Provide the label or Safety Data Sheet to the medical professional.

4.2 Key Symptoms and Effects, Both Acute and Delayed No additional relevant information available.

4.3 Indication of Immediate Medical Attention and Special Treatment No further specific information available.

SECTION 5: Firefighting measures

5.1 Fire & Explosion Information: Non-flammable

5.2 Suitable Extinguishing Agents: Water (for packaging materials)

5.3 Firefighting Instructions: No special measures required

5.4 Potential Fire & Explosion Risks: None

SECTION 6: Accidental release measures

6.1 Personal Precautions: Avoid inhaling dust; use appropriate respiratory protection.

6.2 Clean-up Procedure: Moisten with water and collect by sweeping.

SECTION 7: Handling and storage

7.1 Safe Handling: To prevent irritation of the nose and throat, wear a simple dust mask. If processing involves chemicals, solvents, or other volatile materials, ensure good ventilation and use appropriate respiratory protection.



LAVA 20 CHOPPED STRAND MATTING

Safety Data Sheet

According to Regulation (EC) No. 1907/2006 (REACH) with its Amendment Regulation (EC) No. 1272/2008 (CLP) and EU 2020/878

Printing Date 16. 09. 2025

Version Number 3 (replaces version 2)

Revision: 16. 09. 2025

7.2 Storage Guidelines: Store the product in a clean, dry, and well-ventilated area away from moisture.

SECTION 8: Exposure controls/personal protection

8.1 Exposure Limits: Average permissible exposure is 10 mg/m³ for total dust or 5 mg/m³ for respirable dust.

8.2 Protective Measures

Respiratory Protection: Use a dust mask if airborne dust levels become excessive.

Body Protection: Wear long-sleeved clothing with cuffs secured at the wrists and neck, along with full-length trousers.

Skin Protection: Protective gloves recommended.

Eye Protection: Safety goggles or glasses should be worn.

SECTION 9: Physical and chemical properties

9.1 Information on basic physical and chemical properties

General Information

Physical state	White fiber
Colour:	Colourless
Odour:	Odourless
Melting point:	About 845°C
Solubility in Water:	Insoluble
PH	Not determined
Vapour density	Not determined
Specific gravity	2.54 g/cm ³
Flash point	Not determined
Flammable	Not determined

9.2 Other Information No further relevant information available.



LAVA 20 CHOPPED STRAND MATTING

Safety Data Sheet

According to Regulation (EC) No. 1907/2006 (REACH) with its Amendment Regulation (EC) No. 1272/2008 (CLP) and EU 2020/878

Printing Date 16. 09. 2025

Version Number 3 (replaces version 2)

Revision: 16. 09. 2025

SECTION 10: Stability and reactivity

10.1 Conditions to Avoid: None

10.2 Incompatible Materials: None

10.3 Hazardous Decomposition: In the event of a fire, sizing or binders may break down, releasing primary combustion products such as carbon monoxide, carbon dioxide, and water.

SECTION 11: Toxicological information

11.1 General Toxicity: No data available.

Skin Contact: May cause irritation, mainly during cutting, trimming, or grinding processes.

Eye Contact: Dust particles may irritate the eyes.

Sensitization: None

Chronic Toxicity: None

Genetic Toxicity: None

Reproductive Toxicity: None

Carcinogenicity: None

SECTION 12: Ecological information

As an amorphous material, the product presents no significant environmental hazards.

SECTION 13: Disposal considerations

13.1 Waste Disposal Methods

Recommendation:

Follow national regulations for proper disposal of waste.

Consult the manufacturer for details on recycling options.



SECTION 14: Transport information

14.1 UN number or ID number ADR, ADN, IMDG, IATA	Not classified as dangerous for transport. Void
14.2 UN proper shipping name ADR, ADN, IMDG, IATA	Void
14.3 Transport hazard class(es) ADR, ADN, IMDG, IATA Class	Void
14.4 Packing group ADR, IMDG, IATA	Void



LAVA 20 CHOPPED STRAND MATTING

Safety Data Sheet

According to Regulation (EC) No. 1907/2006 (REACH) with its Amendment Regulation (EC) No. 1272/2008 (CLP) and EU 2020/878

Printing Date 16. 09. 2025

Version Number 3 (replaces version 2)

Revision: 16. 09. 2025

14.5 Environmental hazards:	Not applicable.
14.6 Special precautions for user	Not applicable.
14.7 Maritime transport in bulk according to IMO instruments	Not applicable
UN "Model Regulation":	Void

SECTION 15: Regulatory information

15.1 EEC Labelling: Classified as non-dangerous; no labelling required under Directive 67/548/EEC.

SECTION 16: Other information

The information provided here reflects our current understanding. It does not serve as a guarantee of specific product properties, nor does it create a legally binding agreement.

Training Recommendations

Employees should receive appropriate training on safe handling, storage, and processing of the product, utilizing all available information as a reference. Classification Under Regulation (EC) No 1272/2008

Department issuing SDS:



OWL WATERPROOFING SOLUTIONS

135 Slaney Road, Dublin Industrial Estate
Glasnevin, Dublin 11

Tel: +353 01 830 2250

Email: info@owlwaterproofing.co.uk

Website: www.owlwaterproofing.co.uk

Version number of previous version: 1

Abbreviations and acronyms:

ADR: Accord relatif au transport international des marchandises dangereuses par route (European Agreement Concerning the International Carriage of Dangerous Goods by Road)

IMDG: International Maritime Code for Dangerous Goods

IATA: International Air Transport Association

GHS: Globally Harmonised System of Classification and Labelling of Chemicals

EINECS: European Inventory of Existing Commercial Chemical Substances

CAS: Chemical Abstracts Service (division of the American Chemical Society)

PBT: Persistent, Bioaccumulative and Toxic

SVHC: Substances of Very High Concern

vPvB: very Persistent and very Bioaccumulative

*** Data compared to the previous version altered.**



LAVA 20 POLYESTER REINFORCING FABRIC

Safety Data Sheet

According to Regulation (EC) No. 1907/2006 (REACH) with its Amendment Regulation (EC) No. 1272/2008 (CLP) and EU 2020/878

Printing Date 16. 09. 2025

Version Number 3 (replaces version 2)

Revision: 16. 09. 2025

SECTION 1: Identification of the substance/mixture and of the company/undertaking

1.1 Product identifier

Trade name: LAVA 20 POLYESTER REINFORCING FABRIC

1.2 Relevant identified uses of the substance or mixture and uses advised against

No further relevant information available.

Application of the substance / the mixture: Non-woven polyester geotextile designed to reinforce Lava 20 liquid-applied waterproofing membranes.

1.3 Details of the supplier of the safety data sheet

Manufacturer/Supplier:

OWL WATERPROOFING SOLUTIONS

135 Slaney Road, Dublin Industrial Estate

Glasnevin, Dublin 11

Tel: +353 01 830 2250

Email: info@owlwaterproofing.co.uk

Website: www.owlwaterproofing.co.uk

1.4 Emergency telephone number:

European Emergency Tel.: +353 01 830 2250

SECTION 2: Hazards identification

2.1 Substance or Mixture Classification

Classification as per Regulation (EC) No 1272/2008 (CLP): The substance is not classified under the CLP regulation.

2.2 Label Elements

Labelling in Accordance with Regulation (EC) No 1272/2008 (CLP): Not applicable.

Hazard Pictograms: None

Signal Word: None

Hazard Statements: None

2.3 Additional Hazards

PBT and vPvB Assessment:

This product does not contain any components classified as persistent, bioaccumulative, and toxic (PBT) or as very persistent and very bioaccumulative (vPvB).

PBT: Not applicable

vPvB: Not applicable

Assessment of Endocrine-Disrupting Properties:

The product does not include substances listed under Article 59(1) of REACH for endocrine-disrupting effects, nor has it been identified as having such properties according to the criteria set out in Commission Delegated Regulation (EU) 2017/2100 or Commission Regulation (EU) 2018/605 at levels of 0.1% or higher.



LAVA 20 POLYESTER REINFORCING FABRIC

Safety Data Sheet

According to Regulation (EC) No. 1907/2006 (REACH) with its Amendment Regulation (EC) No. 1272/2008 (CLP) and EU 2020/878

Printing Date 16. 09. 2025

Version Number 3 (replaces version 2)

Revision: 16. 09. 2025

SECTION 3: Composition/information on ingredients

This product contains no ingredients classified as hazardous, nor any hazardous ingredients above the GHS cut-off level.

SECTION 4: First aid measures

4.1 Description

General Advice:

Move the affected individual to an area with fresh air.

Seek prompt medical attention.

If Inhaled:

Ensure the person has access to fresh air and call a doctor for further assistance.

If the person is unconscious, position them on their side for safe transportation.

Skin Contact:

Wash the affected area immediately with soap and water, and rinse thoroughly.

If irritation persists, seek medical advice.

If in Eyes:

Rinse eyes thoroughly with water, gently lifting both the upper and lower eyelids.

Remove contact lenses if present.

Continue rinsing for at least 15 minutes.

Seek medical care if irritation continues.

If Swallowed:

Have the person drink plenty of water and ensure access to fresh air. Contact a doctor immediately.

Provide the label or Safety Data Sheet to the medical professional.

4.2 Key Symptoms and Effects, Both Acute and Delayed No additional relevant information available.

4.3 Indication of Immediate Medical Attention and Special Treatment No further specific information available.

SECTION 5: Firefighting measures

5.1 Extinguishing Media Appropriate Extinguishing Methods: Use CO₂, dry powder, or water spray to extinguish fires.

Inappropriate Extinguishing Methods: Avoid using a full jet of water for safety reasons.

5.2 Special Hazards from the Substance or Mixture: Hazardous decomposition: Thermal decomposition of the fiber coating may release irritating smoke and fumes.

5.3 Firefighting Advice

Protective Gear: Firefighters should wear self-contained breathing apparatus and protective clothing when dealing with a fire involving this substance.

Additional Information: Collect firefighting water that has been contaminated separately, ensuring it does not enter the sewage system.



LAVA 20 POLYESTER REINFORCING FABRIC

Safety Data Sheet

According to Regulation (EC) No. 1907/2006 (REACH) with its Amendment Regulation (EC) No. 1272/2008 (CLP) and EU 2020/878

Printing Date 16. 09. 2025

Version Number 3 (replaces version 2)

Revision: 16. 09. 2025

SECTION 6: Accidental release measures

6.1 Personal Precautions, Protective Gear, and Emergency Measures

Use appropriate protective equipment and ensure that unprotected individuals are kept away.

Avoid any contact with skin and eyes.

6.1.1 For Non-Emergency Personnel Utilize personal protective equipment when handling the product.

6.1.2 For Emergency Responders First-aid responders should be equipped with protective clothing, gloves, goggles, and a respiratory device with an A-type filter.

6.2 Environmental Precautions Prevent the product from contaminating sewers, waterways, or other aquatic environments.

6.3 Containment and Cleanup Methods Gather the waste fabric, transfer it into an appropriate disposal container, and handle it through recycling, controlled incineration, or landfill as permitted by local disposal guidelines

SECTION 7: Handling and storage

7.1 Safe Handling Precautions

Avoid direct contact with skin and eyes.

Do not consume food, drinks, or smoke while handling this product.

Wash hands thoroughly after use.

Fire and Explosion Safety: No specific protective measures are necessary.

7.2 Safe Storage Conditions, Including Incompatibilities

Ensure containers are handled gently to avoid breakage or leaks. Store the material in a temperature-controlled facility (below 60°C) fitted with a sprinkler system, and keep it elevated from the floor to protect against potential water exposure. Incompatible materials: No information available.

7.3 Specific End Uses No additional relevant information is available.

SECTION 8: Exposure controls/personal protection

8.1 Control Parameters There are no ingredients requiring workplace limit value monitoring.

Exposure limits for nuisance dust are set at OSHA PEL: 15 mg/m³ (50 mppcf) TWA and ACGIH: 10 mg/m³.

8.2 Exposure Controls

8.2.1 Appropriate Engineering Controls No additional recommendations; refer to Section 7.

Personal Protection Measures

General Hygiene and Safety Practices:

Keep away from food, beverages, and animal feed.

Wash hands before breaks and after completing tasks.

Store protective gear separately from other clothing.

Prevent direct contact with skin and eyes.

Respiratory Protection:



For short-term exposure or in low-risk environments, use a respiratory filter. For extended or more intense exposure, wear a self-contained respiratory protection device.



LAVA 20 POLYESTER REINFORCING FABRIC

Safety Data Sheet

According to Regulation (EC) No. 1907/2006 (REACH) with its Amendment Regulation (EC) No. 1272/2008 (CLP) and EU 2020/878

Printing Date 16. 09. 2025

Version Number 3 (replaces version 2)

Revision: 16. 09. 2025

Hand Protection



Wear appropriate gloves compliant with EN 374 standards.

The gloves must be impermeable and resistant to the product or substance.

Due to a lack of specific testing, no particular glove material can be recommended for this product or mixture. Choose glove materials based on penetration time, diffusion rates, and resistance to degradation.

Material Selection for Gloves

The choice of suitable gloves depends not only on the material but also on other quality factors, which can differ between manufacturers. Since the product is a combination of various substances, glove resistance should be verified prior to use.

Penetration Time of Glove Material

Penetration times, as defined by EN 16523-1:2015, are determined under laboratory conditions and may not reflect practical use. Therefore, it is recommended to limit wearing time to 50% of the stated penetration time.

Eye/Face Protection



Wear protective goggles during packaging and processing tasks.

Body Protection



Use appropriate protective work clothing.

SECTION 9: Physical and chemical properties

9.1 Information on basic physical and chemical properties

General Information

Physical state	Fabric Solid
Colour:	Colourless
Odour:	Odourless
Odour threshold:	Not determined



LAVA 20 POLYESTER REINFORCING FABRIC

Safety Data Sheet

According to Regulation (EC) No. 1907/2006 (REACH) with its Amendment Regulation (EC) No. 1272/2008 (CLP) and EU 2020/878

Printing Date 16. 09. 2025

Version Number 3 (replaces version 2)

Revision: 16. 09. 2025

Melting point/freezing point:	Not determined
Boiling point or initial boiling point and boiling range	Not specified
Flammability	Product is not flammable
Lower and upper explosion limit Lower: Upper:	Not determined Not determined
Flash point:	Not Flammable
Auto-ignition temperature:	Not specified
Decomposition temperature:	Not determined
pH	Not applicable
Viscosity: Kinematic viscosity	Not applicable
Dynamic:	Not applicable
Solubility water:	Insoluble
Partition coefficient n-octanol/water (log value)	Not determined
Vapour pressure:	Not applicable
Density and/or relative density Density: Relative density Vapour density	Not determined Not determined Not applicable



LAVA 20 POLYESTER REINFORCING FABRIC

Safety Data Sheet

According to Regulation (EC) No. 1907/2006 (REACH) with its Amendment Regulation (EC) No. 1272/2008 (CLP) and EU 2020/878

Printing Date 16. 09. 2025

Version Number 3 (replaces version 2)

Revision: 16. 09. 2025

9.2 Other Information No further relevant information available.

SECTION 10: Stability and reactivity

10.1 Reactivity Hazardous polymerization will not occur.

10.2 Chemical Stability The product remains stable under normal environmental temperatures, with no thermal decomposition expected.

10.3 Potential for Hazardous Reactions No known hazardous reactions under standard conditions.

10.4 Conditions to Avoid Combustible when exposed to open flames.

10.5 Incompatible Materials No further information on incompatible substances is available.

10.6 Hazardous Decomposition Products When exposed to high temperatures, the fiber coating may break down and release irritating smoke and fumes.

SECTION 11: Toxicological information

This product contains no hazardous ingredients above GHS cut-off levels. Where specific LD50 data is unavailable, acute toxicity estimates (ATE) were calculated using conversion methods.

Hazard Classification:

Acute toxicity (oral, dermal, inhalation): Not applicable

Skin/eye irritation or corrosion: Not applicable

Respiratory or skin sensitization: Not applicable

Germ cell mutagenicity, carcinogenicity, reproductive toxicity: Not applicable

STOT (single or repeated exposure), aspiration hazard: Not applicable

SECTION 12: Ecological information

12.1 Toxicity

Aquatic Toxicity: No additional relevant information available.

12.2 Persistence and Degradability No further information is currently available.

12.3 Bioaccumulative Potential No relevant data available.

12.4 Mobility in Soil No further information is available.

12.5 PBT and vPvB Assessment

The product does not contain components classified as persistent, bioaccumulative, and toxic (PBT) or as very persistent and very bioaccumulative (vPvB) at concentrations of 0.1% or higher, in accordance with REACH Annex XIII.

PBT: Not applicable

vPvB: Not applicable

12.6 Endocrine Disrupting Properties

The product does not include substances listed under Article 59(1) of REACH for endocrine-disrupting effects, nor has it been identified as having endocrine-disrupting properties based on the criteria in Commission Delegated Regulation (EU) 2017/2100 or Commission Regulation (EU) 2018/605 at concentrations of 0.1% or more.



LAVA 20 POLYESTER REINFORCING FABRIC

Safety Data Sheet

According to Regulation (EC) No. 1907/2006 (REACH) with its Amendment Regulation (EC) No. 1272/2008 (CLP) and EU 2020/878

Printing Date 16. 09. 2025

Version Number 3 (replaces version 2)

Revision: 16. 09. 2025

SECTION 13: Disposal considerations

13.1 Waste Disposal Methods

Recommendation:

Follow national regulations for proper disposal of waste.
Consult the manufacturer for details on recycling options.



SECTION 14: Transport information

14.1 UN number or ID number ADR, ADN, IMDG, IATA	Not classified as dangerous for transport. Void
14.2 UN proper shipping name ADR, ADN, IMDG, IATA	Void
14.3 Transport hazard class(es) ADR, ADN, IMDG, IATA Class	Void
14.4 Packing group ADR, IMDG, IATA	Void
14.5 Environmental hazards:	Not applicable.
14.6 Special precautions for user	Not applicable.
14.7 Maritime transport in bulk according to IMO instruments	Not applicable
UN "Model Regulation":	Void

SECTION 15: Regulatory information

The regulatory information in Section 15 is not exhaustive; only key regulations are included.

Toxic Substances Control Act (TSCA): All components are listed or exempt from the TSCA Inventory.

WHMIS Classification: Not regulated.

US EPA Tier II Hazards:



LAVA 20 POLYESTER REINFORCING FABRIC

Safety Data Sheet

According to Regulation (EC) No. 1907/2006 (REACH) with its Amendment Regulation (EC) No. 1272/2008 (CLP) and EU 2020/878

Printing Date 16. 09. 2025

Version Number 3 (replaces version 2)

Revision: 16. 09. 2025

Fire: No

Sudden Release of Pressure: No

Reactive: No

Immediate (Acute): No

Delayed (Chronic): No

EPCRA 311/312, EPCRA 302, EPCRA 313: No chemicals present at reportable levels.

Proposition 65 (Carcinogens, Developmental, Female Repro, Male Repro Toxins): No chemicals present at reportable levels.

New Jersey RTK Substances (>1%): None listed.

Pennsylvania RTK Substances (>1%): None listed.

SECTION 16: Other information

The information provided here reflects our current understanding. It does not serve as a guarantee of specific product properties, nor does it create a legally binding agreement.

Training Recommendations

Employees should receive appropriate training on safe handling, storage, and processing of the product, utilizing all available information as a reference. Classification Under Regulation (EC) No 1272/2008

Department issuing SDS:



OWL WATERPROOFING SOLUTIONS

135 Slaney Road, Dublin Industrial Estate
Glasnevin, Dublin 11

Tel: +353 01 830 2250

Email: info@owlwaterproofing.co.uk

Website: www.owlwaterproofing.co.uk

Version number of previous version: 1

Abbreviations and acronyms:

ADR: Accord relatif au transport international des marchandises dangereuses par route (European Agreement Concerning the International Carriage of Dangerous Goods by Road)

IMDG: International Maritime Code for Dangerous Goods

IATA: International Air Transport Association

GHS: Globally Harmonised System of Classification and Labelling of Chemicals

EINECS: European Inventory of Existing Commercial Chemical Substances

CAS: Chemical Abstracts Service (division of the American Chemical Society)

PBT: Persistent, Bioaccumulative and Toxic

SVHC: Substances of Very High Concern

vPvB: very Persistent and very Bioaccumulative

* **Data compared to the previous version altered.**



LAVA 20 CATALYST

Safety Data Sheet

According to Regulation (EC) No. 1907/2006 (REACH) with its Amendment Regulation (EC) No. 1272/2008 (CLP) and EU 2020/878

Printing Date 14. 12. 2023

Version Number 5 (replaces version 4)

Revision: 14. 12. 2023

SECTION 1: Identification of the substance/mixture and of the company/undertaking

1.1 Product identifier

Trade name: LAVA 20 CATALYST

1.2 Relevant identified uses of the substance or mixture and uses advised against Professional use

Application of the substance / the mixture: Accelerating Additive

1.3 Details of the supplier of the safety data sheet

Manufacturer/Supplier:

OWL WATERPROOFING SOLUTIONS

135 Slaney Road, Dublin Industrial Estate

Glasnevin, Dublin 11

Tel: +353 01 830 2250

Email: info@owlwaterproofing.co.uk

Website: www.owlwaterproofing.co.uk

1.4 Emergency telephone number:

European Emergency Tel.: +353 01 830 2250

SECTION 2: Hazards identification

2.1 Classification of the substance or mixture

Classification according to Regulation EC No 1272/2008 CLP:

GHS02 flame



Flam. Liq. 3 H226 Flammable liquid and vapour.

GHS08 health hazard



STOT RE 2 H373 May cause damage to organs through prolonged or repeated exposure.

Asp. Tox. 1 H304 May be fatal if swallowed and enters airways.

GHS07



Acute Tox. 4 H312 Harmful in contact with skin.

Acute Tox. 4 H332 Harmful if inhaled.

Skin Irrit. 2 H315 Causes skin irritation.

Eye Irrit. 2 H319 Causes serious eye irritation.

STOT SE 3 H335 May cause respiratory irritation.



LAVA 20 CATALYST

Safety Data Sheet

According to Regulation (EC) No. 1907/2006 (REACH) with its Amendment Regulation (EC) No. 1272/2008 (CLP) and EU 2020/878

Printing Date 14. 12. 2023

Version Number 5 (replaces version 4)

Revision: 14. 12. 2023

GHS09 environment



Aquatic Chronic 2 H411 Toxic to aquatic life with long lasting effects.

2.2 Label elements

Labelling according to Regulation EC No 1272/2008 CLP:

The product is classified and labelled according to the CLP regulation.

Hazard pictograms:



GHS02

GHS07

GHS08

GHS09

Signal word: Danger

Hazard-determining components of labelling:

Reaction mass of ethylbenzene and m-xylene and p-xylene diethylmethylenediamine

Hazard statements:

H226 Flammable liquid and vapour.

H312+H332 Harmful in contact with skin or if inhaled.

H315 Causes skin irritation.

H319 Causes serious eye irritation.

H335 May cause respiratory irritation.

H373 May cause damage to organs through prolonged or repeated exposure.

H304 May be fatal if swallowed and enters airways.

H411 Toxic to aquatic life with long lasting effects.

Precautionary statements

P210 Keep away from heat, hot surfaces, sparks, open flames and other ignition sources. No smoking.

P260 Do not breathe dust/fume/gas/mist/vapours/spray.

P273 Avoid release to the environment.

P280 Wear protective gloves/protective clothing/eye protection/face protection/hearing protection.

P301+P310 IF SWALLOWED: Immediately call a POISON CENTER/ doctor.

P501 Dispose of contents/container in accordance with local/regional/national/international regulations.

2.3 Other hazards

Results of PBT and vPvB assessment

The product does not include any substances identified as persistent, bioaccumulative, and toxic (PBT) or as very persistent and very bioaccumulative (vPvB) at concentrations equal to or above 0.1%.

PBT: Not applicable.

vPvB: Not applicable.



LAVA 20 CATALYST

Safety Data Sheet

According to Regulation (EC) No. 1907/2006 (REACH) with its Amendment Regulation (EC) No. 1272/2008 (CLP) and EU 2020/878

Printing Date 14. 12. 2023

Version Number 5 (replaces version 4)

Revision: 14. 12. 2023

Assessment of Endocrine-Disrupting Properties

The product does not contain substances listed under Article 59(1) of REACH for endocrine-disrupting effects, nor has it been identified as having endocrine-disrupting properties based on the criteria specified in Commission Delegated Regulation (EU) 2017/2100 or Commission Regulation (EU) 2018/605 at concentrations of 0.1% or higher.

SECTION 3: Composition/information on ingredients

3.2 Mixtures

Description: Mixture: consisting of the following components.

Ingredients according Regulation (EU) 2020/878:

EC number: 905-562-9 Reg.nr.: 01- 2119488216-32-XXXX	Reaction mass of ethylbenzene and m-xylene and p-xylene Flam. Liq. 3, H226; STOT RE 2, H373; Asp. Tox. 1, H304; Acute Tox. 4, H312; Acute Tox. 4, H332; Skin Irrit. 2, H315; Eye Irrit. 2, H319; STOT SE 3, H335; Aquatic Chronic 3, H412 Specific concentration limit: STOT RE 2; H373: C \geq 10 %	>50-<90%
CAS: 68479-98-1 EINECS: 270-877-4 Index number: 612- 130-00-0 Reg.nr.: 01- 2119486805-25-XXXX	diethylmethylenediamine STOT RE 2, H373; Aquatic Acute 1, H400; Aquatic Chronic 1, H410; Acute Tox. 4, H302; Acute Tox. 4, H312; Eye Irrit. 2, H319	\geq 10-<25%

Substances of Very High Concern (SVHC)

This product does not contain any candidate substances classified as very high concern (SVHC) at concentrations of 0.1% or more, as per Regulation (EC) No 1907/2006 (REACH), Article 59.

Additional information: Refer to section 16 for the wording of the listed hazard phrases.

SECTION 4: First aid measures

4.1 Description of First Aid Measures

General Information:

Move the affected person to fresh air immediately.

Seek prompt medical assistance.

After Inhalation:

Ensure access to fresh air; seek medical attention.

If the person is unconscious, place them in a stable side position for transport.

Obtain medical care if symptoms persist.



LAVA 20 CATALYST

Safety Data Sheet

According to Regulation (EC) No. 1907/2006 (REACH) with its Amendment Regulation (EC) No. 1272/2008 (CLP) and EU 2020/878

Printing Date 14. 12. 2023

Version Number 5 (replaces version 4)

Revision: 14. 12. 2023

After Skin Contact:

Wash thoroughly with water and soap, then rinse well.

If irritation persists, consult a healthcare professional.

After Eye Contact:

Rinse eyes immediately with plenty of water, lifting both upper and lower eyelids.

Remove contact lenses if present and continue rinsing for at least 15 minutes.

Seek medical attention if irritation develops.

After Swallowing:

Do not induce vomiting; seek medical assistance immediately.

Drink plenty of water and get fresh air. Call for medical help right away.

Never give anything orally to an unconscious person.

4.2 Most Important Symptoms and Effects, Both Acute and Delayed

No additional relevant information available.

4.3 Indication of Immediate Medical Attention and Special Treatment Needed

No further relevant information available.

SECTION 5: Firefighting measures

5.1 Extinguishing Media

Suitable Extinguishing Agents: CO₂, dry powder, or water spray.

Unsuitable Extinguishing Agents: Avoid using water with a full jet for safety reasons.

5.2 Special Hazards Arising from the Substance or Mixture

Potential release of carbon dioxide (CO₂) and carbon monoxide (CO).

5.3 Advice for Firefighters

Protective Equipment:

Use a mouth respiratory protective device.

Wear a fully protective suit.

Additional Information:

Collect contaminated firefighting water separately; it must not be allowed to enter the sewage system.

SECTION 6: Accidental release measures

6.1 Personal Precautions, Protective Equipment, and Emergency Procedures

Wear appropriate protective equipment and keep unprotected individuals away.

Avoid inhaling vapors

Prevent contact with skin and eyes.

Wear protective clothing and keep away from ignition sources.

6.1.1 For Non-Emergency Personnel Avoid contact with leaking or dripping material.

6.1.2 For Emergency Responders First-aid responders should wear protective clothing, gloves, goggles, and a respiratory device with filter type A.

6.2 Environmental Precautions

Prevent the material from penetrating the ground or soil.

Avoid releasing it into sewers, surface water, or groundwater.



LAVA 20 CATALYST

Safety Data Sheet

According to Regulation (EC) No. 1907/2006 (REACH) with its Amendment Regulation (EC) No. 1272/2008 (CLP) and EU 2020/878

Printing Date 14. 12. 2023

Version Number 5 (replaces version 4)

Revision: 14. 12. 2023

6.3 Methods and Material for Containment and Cleaning Up: Use absorbent materials such as sand or diatomite to collect the spill.

6.4 Reference to Other Sections

Refer to Section 7 for safe handling information.

Refer to Section 8 for details on personal protective equipment.

Refer to Section 13 for disposal information.

SECTION 7: Handling and storage

7.1 Precautions for Safe Handling

Ensure adequate ventilation or exhaust at the workplace.

Avoid direct contact with skin and eyes.

Do not eat, drink, or smoke while handling this product.

Wash contaminated clothing before wearing it again.

Thoroughly wash hands after use.

Information About Fire and Explosion Protection:

Keep away from ignition sources; smoking is prohibited.

Take measures to prevent electrostatic charges.



7.2 Conditions for Safe Storage, Including Any Incompatibilities

Storage: Store in well-sealed containers in well-ventilated, cool areas.

Requirements for Storerooms and Containers:

Maintain a cool storage environment.

Prevent seepage into the ground.

Information About Common Storage Facilities: Keep separate from oxidizing agents.

Additional Storage Conditions:

Ensure containers are tightly sealed.

Protect from heat and direct sunlight.

7.3 Specific End Use(s) No additional relevant information available.

SECTION 8: Exposure controls/personal protection

8.1 Control Parameters

Ingredients with Limit Values Requiring Monitoring at the Workplace:

The product does not contain significant quantities of substances with critical values that need monitoring.

DNELs:

(EC: 905-562-9) Reaction mass of ethylbenzene, m-xylene, and p-xylene

Workers:

Long-term systemic effect (Inhalation): 77 mg/m³

Long-term systemic effect (Dermal): 180 mg/kg bw/day

Short-term systemic effect (Inhalation): 442 mg/m³

Consumers:

Long-term systemic effect (Oral): 1.6 mg/kg bw/day

Long-term systemic effect (Inhalation): 15 mg/m³

Long-term systemic effect (Dermal): 125 mg/kg bw/day

Short-term systemic effect (Inhalation): 260 mg/m³



LAVA 20 CATALYST

Safety Data Sheet

According to Regulation (EC) No. 1907/2006 (REACH) with its Amendment Regulation (EC) No. 1272/2008 (CLP) and EU 2020/878

Printing Date 14. 12. 2023

Version Number 5 (replaces version 4)

Revision: 14. 12. 2023

PNECs:

(EC: 905-562-9) Reaction mass of ethylbenzene, m-xylene, and p-xylene

Freshwater: 0.044 mg/l

Marine water: 0.004 mg/l

Freshwater sediment: 2.52 mg/kg

Marine water sediment: 0.252 mg/kg

Soil: 0.852 mg/kg

STP (Wastewater Treatment Plant): 1.6 mg/l

8.2 Exposure Controls

8.2.1 Appropriate Engineering Controls Ensure sufficient ventilation at the workplace.

Individual Protection Measures (Personal Protective Equipment):

General Protective and Hygienic Measures:

Keep away from food, beverages, and animal feed.

Wash hands before breaks and after finishing work.

Avoid inhaling vapors or mists.

Do not eat, drink, or smoke while handling the product.

Prevent contact with skin and eyes.

Remove and clean contaminated clothing before reusing

Respiratory Protection:



Use an appropriate respiratory device if ventilation is inadequate. Respiratory protection is essential in poorly ventilated areas and during spraying. An air-fed mask is recommended, or for short-term tasks, a combination of a charcoal filter and particulate filter A2-P2 (EN529) can be used.

Hand Protection:



Wear chemical-resistant protective gloves (compliant with EN 374-1 standards).

The gloves must be impermeable and resistant to the substances in the product. Choose the glove material based on penetration times, diffusion rates, and degradation properties.

Glove Materials:

For handling the product at room temperature:

Butyl rubber (IIR): thickness ≥ 0.5 mm; breakthrough time ≥ 480 minutes.

Fluorinated rubber (FKM): thickness ≥ 0.4 mm; breakthrough time ≥ 480 minutes.

Recommendation: dispose of contaminated gloves.

Selecting appropriate gloves depends not only on the material but also on additional quality indicators, which can vary between manufacturers. Since the product is a mixture, glove resistance must be tested before use.



LAVA 20 CATALYST

Safety Data Sheet

According to Regulation (EC) No. 1907/2006 (REACH) with its Amendment Regulation (EC) No. 1272/2008 (CLP) and EU 2020/878

Printing Date 14. 12. 2023

Version Number 5 (replaces version 4)

Revision: 14. 12. 2023

Penetration Time of Glove Material:

≥480 minutes. The specified penetration times according to EN 16523-1:2015 are not based on practical use. Thus, a maximum wear time of 50% of the penetration time is recommended.

Eye/Face Protection:



Use safety glasses with side shields (frame goggles) compliant with EN 166.

Body Protection:



Wear chemically resistant protective clothing (EN 14605) and boots.

Environmental Exposure Controls:

Prevent the product from entering drains, surface water, groundwater, and soil.

SECTION 9: Physical and chemical properties

9.1 Information on basic physical and chemical properties

General Information

Physical State	Liquid
Colour	Not determined
Odour	Not determined
Odour threshold:	Not determined
Melting point/freezing point:	Not determined
Flammability	Not applicable
Lower and upper explosion limit Lower: Upper:	Not determined Not determined
Flash point:	27 °C (Reaction mass of ethylbenzene and m-xylene and p-xylene)



LAVA 20 CATALYST

Safety Data Sheet

According to Regulation (EC) No. 1907/2006 (REACH) with its Amendment Regulation (EC) No. 1272/2008 (CLP) and EU 2020/878

Printing Date 14. 12. 2023

Version Number 5 (replaces version 4)

Revision: 14. 12. 2023

Auto-ignition temperature:	480 °C
Decomposition temperature:	Not determined
pH	Not determined
Viscosity: Kinematic viscosity	Not determined
Dynamic	Not determined
Solubility: Water	Not miscible
Partition coefficient n-octanol/water (log value)	Not determined
Vapour pressure:	Not determined
Density and/or relative density Density at 20 °C:	0.91 g/cm ³
Relative density	Not determined
Vapour density	Not determined
9.2 Other information Appearance:	
Form	Liquid
Important information on protection of health and environment, and on safety	
Ignition temperature:	Product is not selfigniting.



LAVA 20 CATALYST

Safety Data Sheet

According to Regulation (EC) No. 1907/2006 (REACH) with its Amendment Regulation (EC) No. 1272/2008 (CLP) and EU 2020/878

Printing Date 14. 12. 2023

Version Number 5 (replaces version 4)

Revision: 14. 12. 2023

Explosive properties:	Product is not explosive. However, formation of explosive air/vapour mixtures are possible.
Solvent content	
VOC (EC)	<680 g/l
Drip point	
Oxidising properties	Not classified as an oxidizer according to CLP Regulation 1272/2008/EC.
Evaporation rate	Not determined
Information with regard to physical hazard classes	
Explosives	Void
Flammable gases	Void
Aerosols	Void
Oxidising gases	Void
Gases under pressure	Void
Flammable liquids	Flammable liquid and vapour.
Flammable solids	Void
Self-reactive substances and mixtures	Void
Pyrophoric liquids	Void
Pyrophoric solids	Void



LAVA 20 CATALYST

Safety Data Sheet

According to Regulation (EC) No. 1907/2006 (REACH) with its Amendment Regulation (EC) No. 1272/2008 (CLP) and EU 2020/878

Printing Date 14. 12. 2023

Version Number 5 (replaces version 4)

Revision: 14. 12. 2023

Self-heating substances and mixtures	Void
Substances and mixtures, which emit flammable gases in contact with water	Void
Oxidising liquids	Void
Oxidising solids	Void
Organic peroxides	Void
Corrosive to metals	Void
Desensitised explosives	Void

SECTION 10: Stability and reactivity

10.1 Reactivity No additional relevant information available.

10.2 Chemical Stability

The product is stable under normal environmental temperatures; no thermal decomposition is expected.

10.3 Possibility of Hazardous Reactions No known dangerous reactions.

10.4 Conditions to Avoid Avoid exposure to heat, sparks, open flames, or other ignition sources.

10.5 Incompatible Materials Keep away from oxidizing agents.

10.6 Hazardous Decomposition Products

May produce carbon dioxide (CO₂) and carbon monoxide (CO).

SECTION 11: Toxicological information

11.1 Information on Hazard Classes as Defined in Regulation (EC) No 1272/2008

Acute Toxicity: Harmful if it comes into contact with the skin or if inhaled.

LD/LC50 values relevant for classification:

ATE (Acute Toxicity Estimates)

Oral	LD50	2,954 mg/kg (rat)
Dermal	LD50	1,101 mg/kg
Inhalative	LC50/4 h (vapour)	14.7 mg/l



LAVA 20 CATALYST

Safety Data Sheet

According to Regulation (EC) No. 1907/2006 (REACH) with its Amendment Regulation (EC) No. 1272/2008 (CLP) and EU 2020/878

Printing Date 14. 12. 2023

Version Number 5 (replaces version 4)

Revision: 14. 12. 2023

Reaction mass of ethylbenzene and m-xylene and p-xylene

Oral	LD50	>3,523 mg/kg (rat)
Dermal	LD50	>12,126 mg/kg (rabbit)
Inhalative	LC50/4 h (vapour)	>27 mg/l (rat)

CAS: 68479-98-1 diethylmethylenediamine

Oral	LD50	738 mg/kg (rat)
Dermal	LD50	>2,000 mg/kg (rat)

Skin Corrosion/Irritation: Causes irritation to the skin.

Serious Eye Damage/Irritation: Causes significant eye irritation.

Respiratory or Skin Sensitisation: Available data does not meet the criteria for classification.

Germ Cell Mutagenicity: Based on the available data, it does not meet the classification criteria.

Carcinogenicity: The product does not meet the classification criteria based on current data.

Reproductive Toxicity: Available data does not indicate a need for classification.

STOT - Single Exposure:

Classified as Specific Target Organ Toxicity (Category 3) following a single exposure.

May cause irritation to the respiratory system.

STOT - Repeated Exposure:

Classified as Specific Target Organ Toxicity (Category 2) due to prolonged or repeated exposure.

May cause damage to organs over time.

Aspiration Hazard:

Classified under Aspiration Toxicity (Category 1).

May be fatal if swallowed and enters the respiratory tract.

11.2 Information on Other Hazards

Endocrine Disrupting Properties:

The product does not contain substances listed under Article 59(1) of REACH for endocrine-disrupting properties, nor has it been identified as having such properties according to the criteria defined in Commission Delegated Regulation (EU) 2017/2100 or Commission Regulation (EU) 2018/605 at concentrations of 0.1% or more.

None of the ingredients are listed as endocrine disruptors.



LAVA 20 CATALYST

Safety Data Sheet

According to Regulation (EC) No. 1907/2006 (REACH) with its Amendment Regulation (EC) No. 1272/2008 (CLP) and EU 2020/878

Printing Date 14. 12. 2023

Version Number 5 (replaces version 4)

Revision: 14. 12. 2023

SECTION 12: Ecological information

12.1 Toxicity

Aquatic toxicity:

Reaction mass of ethylbenzene and m-xylene and p-xylene

EC50 (72h)	4.6-4.9 mg/l (algae)
EC50 (48h)	10.389 mg/l (Daphnia magna)
LC50 (96h)	>2.6 mg/l (fish)

CAS: 68479-98-1 diethylmethylenediamine

EC50 (48h)	0.5 mg/l (daphnia magna)
------------	--------------------------

12.2 Persistence and Degradability No additional relevant information available.

12.3 Bioaccumulative Potential No additional relevant information available.

12.4 Mobility in Soil No additional relevant information available.

12.5 Results of PBT and vPvB Assessment

The product does not contain ingredients classified as persistent, bioaccumulative, and toxic (PBT), or very persistent and very bioaccumulative (vPvB) at concentrations of 0.1% or higher, as per REACH Annex XIII.

PBT: Not applicable.

vPvB: Not applicable.

12.6 Endocrine Disrupting Properties

The product does not include substances listed under Article 59(1) of REACH for endocrine-disrupting properties, nor has it been identified as having such properties based on the criteria in Commission Delegated Regulation (EU) 2017/2100 or Commission Regulation (EU) 2018/605 at concentrations of 0.1% or more.

12.7 Other Adverse Effects

Remark: Toxic to fish.

Ecological Information:

Notes: Classified as water hazard class 1 (German Regulation) based on self-assessment: slightly hazardous to water. Also toxic to fish and plankton in aquatic environments.

SECTION 13: Disposal considerations

13.1 Waste treatment methods

Recommendation

Dispose of the product in accordance with national regulations.

Do not dispose of with household waste.

Ensure the product does not enter the sewage system.





LAVA 20 CATALYST

Safety Data Sheet

According to Regulation (EC) No. 1907/2006 (REACH) with its Amendment Regulation (EC) No. 1272/2008 (CLP) and EU 2020/878

Printing Date 14. 12. 2023

Version Number 5 (replaces version 4)

Revision: 14. 12. 2023

Contact the manufacturer for information on recycling options.



Refer to the European Waste Catalogue for proper waste classification and disposal.

HP3	Flammable
HP4	Irritant - skin irritation and eye damage
HP5	Specific Target Organ Toxicity (STOT)/Aspiration Toxicity
HP6	Acute Toxicity
HP14	Ecotoxic

Uncleaned Packaging:

Recommendation: Dispose of packaging in accordance with official regulations.

SECTION 14: Transport information

14.1 UN number or ID number ADR, IMDG, IATA	UN1866
14.2 UN proper shipping name ADR IMDG IATA	1866 RESIN SOLUTION, ENVIRONMENTALLY HAZARDOUS RESIN SOLUTION (diethylmethylenediamine), MARINE POLLUTANT RESIN SOLUTION
14.3 Transport hazard class(es) ADR, IMDG   Class Label	3 Flammable liquids. 3



LAVA 20 CATALYST

Safety Data Sheet

According to Regulation (EC) No. 1907/2006 (REACH) with its Amendment Regulation (EC) No. 1272/2008 (CLP) and EU 2020/878

Printing Date 14. 12. 2023

Version Number 5 (replaces version 4)

Revision: 14. 12. 2023

IATA	
	
Class Label	3 Flammable liquids. 3
14.4 Packing group ADR, IMDG, IATA	III
14.5 Environmental hazards:	Environmental Hazardous. Product contains environmentally hazardous substances: diethylmethylbenzenediamine
Marine pollutant:	Yes. Symbol (fish and tree)
Special marking (ADR):	Symbol (fish and tree)
14.6 Special precautions for user	Warning: Flammable liquids.
Hazard identification number (Kemler code):	36
EMS Number:	F-E,<u>S-E</u>
Stowage Category	A
14.7 Maritime Transport in bulk according to IMO instruments	Not applicable.
Transport/Additional information:	
ADR Limited quantities (LQ) Excepted quantities (EQ)	5L Code: E1 Maximum net quantity per inner packaging: 30 ml Maximum net quantity per outer packaging: 1000 ml



LAVA 20 CATALYST

Safety Data Sheet

According to Regulation (EC) No. 1907/2006 (REACH) with its Amendment Regulation (EC) No. 1272/2008 (CLP) and EU 2020/878

Printing Date 14. 12. 2023

Version Number 5 (replaces version 4)

Revision: 14. 12. 2023

Transport category	3
Tunnel restriction code	D/E
IMDG Limited quantities (LQ) Excepted quantities (EQ)	5L Code: E1 Maximum net quantity per inner packaging: 30 ml Maximum net quantity per outer packaging: 1000 ml
UN "Model Regulation":	UN 1866 RESIN SOLUTION, 3, III, ENVIRONMENTALLY HAZARDOUS

SECTION 15: Regulatory information

15.1 Regulations on Safety, Health, and Environment Specific to the Substance or Mixture

Regulation (EC) No. 1907/2006 (REACH), Regulation (EU) 2020/878, Regulation (EC) No. 1272/2008 (CLP)

Directive 98/24/EC concerning the protection of workers from chemical risks in the workplace. Council Directive 94/33/EC on safeguarding young workers, as amended. Directive 92/85/EEC regarding safety and health measures for pregnant employees, new mothers, and breastfeeding workers, as amended

Directive 2012/18/EU

Dangerous Substances Listing - Annex I: The substance is not listed in Annex I.

Seveso Categories:E2: Environmental hazard (Aquatic), P5c: Flammable liquids.

Qualifying Quantities for Seveso Directive Requirements

Lower-tier threshold: 200 tonnes

Upper-tier threshold: 500 tonnes

Regulation (EC) No 1907/2006 (REACH) - Annex XVII Conditions of Restriction: 3

Directive 2011/65/EU (RoHS) - Annex II None of the ingredients are listed under the restriction of hazardous substances in electrical and electronic equipment.

Regulation (EU) 2019/1148 Annex I - Restricted Explosives Precursors: No ingredients listed (upper limit for licensing per Article 5(3)).

Annex II - Reportable Explosives Precursors: No ingredients listed.

Regulation (EC) No 273/2004 on Drug Precursors No ingredients are listed.

Regulation (EC) No 111/2005 on Monitoring Trade in Drug Precursors No ingredients are listed.

National Regulations: None applicable.

Other Regulations, Limitations, and Restrictions

Substances of Very High Concern (SVHC) as per REACH Article 57:

The product does not contain any substances classified as SVHC.

15.2 Chemical Safety Assessment A Chemical Safety Assessment has not been conducted.



LAVA 20 CATALYST

Safety Data Sheet

According to Regulation (EC) No. 1907/2006 (REACH) with its Amendment Regulation (EC) No. 1272/2008 (CLP) and EU 2020/878

Printing Date 14. 12. 2023

Version Number 5 (replaces version 4)

Revision: 14. 12. 2023

SECTION 16: Other information

This information reflects our current understanding. However, it does not serve as a guarantee of specific product characteristics and does not form a legally binding contract.

Relevant phrases

H226 Flammable liquid and vapour.

H302 Harmful if swallowed.

H304 May be fatal if swallowed and enters airways.

H312 Harmful in contact with skin.

H315 Causes skin irritation.

H319 Causes serious eye irritation.

H332 Harmful if inhaled.

H335 May cause respiratory irritation.

H373 May cause damage to organs through prolonged or repeated exposure.

H400 Very toxic to aquatic life.

H410 Very toxic to aquatic life with long lasting effects.

H412 Harmful to aquatic life with long lasting effects.

Training Recommendations

Employees should receive appropriate training on safe handling, storage, and processing of the product, using all available information as a basis.

Classification according to Regulation (EC) No 1272/2008

Flammable liquids	Bridging principles
Acute toxicity - dermal Acute toxicity - inhalation Skin corrosion/irritation Serious eye damage/irritation Specific target organ toxicity (single exposure) Specific target organ toxicity (repeated exposure) Hazardous to the aquatic environment - long-term (chronic) aquatic hazard	The classification of the mixture is generally based on the calculation method using substance data according to Regulation (EC) No 1272/2008.
Aspiration hazard	Expert judgement



LAVA 20 CATALYST

Safety Data Sheet

According to Regulation (EC) No. 1907/2006 (REACH) with its Amendment Regulation (EC) No. 1272/2008 (CLP) and EU 2020/878

Printing Date 14. 12. 2023

Version Number 5 (replaces version 4)

Revision: 14. 12. 2023

Department issuing SDS:



OWL WATERPROOFING SOLUTIONS

135 Slaney Road, Dublin Industrial Estate

Glasnevin, Dublin 11

Tel: +353 01 830 2250

Email: info@owlwaterproofing.co.uk

Website: www.owlwaterproofing.co.uk

Version number of previous version: 4

Abbreviations and acronyms:

ADR: Accord relatif au transport international des marchandises dangereuses par route (European Agreement Concerning the International Carriage of Dangerous Goods by Road)

IMDG: International Maritime Code for Dangerous Goods

IATA: International Air Transport Association

GHS: Globally Harmonised System of Classification and Labelling of Chemicals

EINECS: European Inventory of Existing Commercial Chemical Substances

ELINCS: European List of Notified Chemical Substances

CAS: Chemical Abstracts Service (division of the American Chemical Society)

VOC: Volatile Organic Compounds (USA, EU)

DNEL: Derived No-Effect Level (REACH)

PNEC: Predicted No-Effect Concentration (REACH)

LC50: Lethal concentration, 50 percent

LD50: Lethal dose, 50 percent

PBT: Persistent, Bioaccumulative and Toxic

SVHC: Substances of Very High Concern

vPvB: very Persistent and very Bioaccumulative

ATE: Acute toxicity estimate values

Flam. Liq. 3: Flammable liquids – Category 3

Acute Tox. 4: Acute toxicity – Category 4

Skin Irrit. 2: Skin corrosion/irritation – Category 2

Eye Irrit. 2: Serious eye damage/eye irritation – Category 2

STOT SE 3: Specific target organ toxicity (single exposure) – Category 3

STOT RE 2: Specific target organ toxicity (repeated exposure) – Category 2

Asp. Tox. 1: Aspiration hazard – Category 1

Aquatic Acute 1: Hazardous to the aquatic environment - acute aquatic hazard – Category 1

Aquatic Chronic 1: Hazardous to the aquatic environment - long-term aquatic hazard – Category 1

Aquatic Chronic 2: Hazardous to the aquatic environment - long-term aquatic hazard – Category 2

Aquatic Chronic 3: Hazardous to the aquatic environment - long-term aquatic hazard – Category 3

*** Data compared to the previous version altered.**



LAVA 20

Safety Data Sheet

According to Regulation (EC) No. 1907/2006 (REACH) with its
Amendment Regulation (EC) No. 1272/2008 (CLP) and EU 2020/878

Printing Date 12. 10. 2023

Version Number 6 (replaces version 5)

Revision: 12. 10. 2023

SECTION 1: Identification of the substance/mixture and of the company/undertaking

1.1 Product identifier

Trade name: LAVA 20

1.2 Relevant identified uses of the substance or mixture and uses advised against Professional use

Application of the substance / the mixture: Polyurethane Waterproofing coating

1.3 Details of the supplier of the safety data sheet

Manufacturer/Supplier:

OWL WATERPROOFING SOLUTIONS

135 Slaney Road, Dublin Industrial Estate

Glasnevin, Dublin 11

Tel: +353 01 830 2250

Email: info@owlwaterproofing.co.uk

Website: www.owlwaterproofing.co.uk

1.4 Emergency telephone number:

European Emergency Tel.: +353 01 830 2250

SECTION 2: Hazards identification

2.1 Classification of the substance or mixture

Classification according to Regulation EC No 1272/2008 CLP:

GHS02 flame



Flam. Liq. 3 H226 Flammable liquid and vapour.

GHS08 health hazard



Resp. Sens. 1 H334 May cause allergy or asthma symptoms or breathing difficulties if inhaled.

STOT RE 2 H373 May cause damage to organs through prolonged or repeated exposure.

Asp. Tox. 1 H304 May be fatal if swallowed and enters airways.

GHS07



Skin Irrit. 2 H315 Causes skin irritation.

Eye Irrit. 2 H319 Causes serious eye irritation.

Skin Sens. 1 H317 May cause an allergic skin reaction.

Aquatic Chronic 3 H412 Harmful to aquatic life with long lasting effects.



LAVA 20

Safety Data Sheet

According to Regulation (EC) No. 1907/2006 (REACH) with its Amendment Regulation (EC) No. 1272/2008 (CLP) and EU 2020/878

Printing Date 12. 10. 2023

Version Number 6 (replaces version 5)

Revision: 12. 10. 2023

2.2 Label elements

Labelling according to Regulation EC No 1272/2008 CLP:

The product is classified and labelled according to the CLP regulation.

Hazard pictograms:



GHS02 GHS08

Signal word: Danger

Hazard-determining components of labelling:

Reaction mass of ethylbenzene and m-xylene and p-xylene

m-tolylidene diisocyanate

4,5-dichloro-2-octyl-2H-isothiazol-3-one

Hazard statements:

H226 Flammable liquid and vapour.

H315 Causes skin irritation.

H319 Causes serious eye irritation.

H334 May cause allergy or asthma symptoms or breathing difficulties if inhaled.

H317 May cause an allergic skin reaction.

H373 May cause damage to organs through prolonged or repeated exposure.

H304 May be fatal if swallowed and enters airways.

H412 Harmful to aquatic life with long lasting effects.

Precautionary statements

P210 Keep away from heat, hot surfaces, sparks, open flames and other ignition sources. No smoking.

P261 Avoid breathing dust/fume/gas/mist/vapours/spray.

P273 Avoid release to the environment.

P280 Wear protective gloves/protective clothing/eye protection/face protection/hearing protection.

P301+P310 IF SWALLOWED: Immediately call a POISON CENTER/ doctor.

P331 Do NOT induce vomiting.

P302+P352 IF ON SKIN: Wash with plenty of water and soap.

P304+P340 IF INHALED: Remove person to fresh air and keep comfortable for breathing.

P305+P351+P338 IF IN EYES: Rinse cautiously with water for several minutes. Remove contact lenses, if present and easy to do. Continue rinsing.

P403+P235 Store in a well-ventilated place. Keep cool.

P501 Dispose of contents/container in accordance with local/regional/national/international regulations.

Additional information:

EUH211 Warning! Hazardous respirable droplets may be formed when sprayed. Do not breathe spray or mist.

2.3 Other hazards

Results of PBT and vPvB assessment

PBT: Not applicable

vPvB: Not applicable.



LAVA 20

Safety Data Sheet

According to Regulation (EC) No. 1907/2006 (REACH) with its Amendment Regulation (EC) No. 1272/2008 (CLP) and EU 2020/878

Printing Date 12. 10. 2023

Version Number 6 (replaces version 5)

Revision: 12. 10. 2023

SECTION 3: Composition/information on ingredients

3.2 Mixtures

Description: Mixture: consisting of the following components.

Ingredients according Regulation (EU) 2020/878:

EC number: 905-562-9 Reg.nr.: 01-2119488216-32-XXXX	Reaction mass of ethylbenzene and m-xylene and p-xylene Flam. Liq. 3, H226; STOT RE 2, H373; Asp. Tox. 1, H304; Acute Tox. 4, H312; Acute Tox. 4, H332; Skin Irrit. 2, H315; Eye Irrit. 2, H319; STOT SE 3, H335; Aquatic Chronic 3, H412	≥15-<20%
CAS: 26471-62-5 EINECS: 247-722-4 Index number: 615-006-00-4 Reg.nr.: 01-2119454791-34-XXXX	m-tolyldiene diisocyanate Acute Tox. 2, H330; Resp. Sens. 1, H334; Carc. 2, H351; Skin Irrit. 2, H315; Eye Irrit. 2, H319; Skin Sens. 1, H317; STOT SE 3, H335; Aquatic Chronic 3, H412, EUH204 Specific concentration limit: Resp. Sens. 1; H334: C ≥ 0.1 %	0.1-<0.5%
CAS: 64359-81-5 EINECS: 264-843-8 Index number: 613-335-00-8	4,5-dichloro-2-octyl-2H-isothiazol-3-one Acute Tox. 2, H330; Skin Corr. 1, H314; Eye Dam. 1, H318; Aquatic Acute 1, H400 (M=100); Aquatic Chronic 1, H410 (M=100); Acute Tox. 4, H302; Skin Sens. 1A, H317 ATE: LD50 oral: 567 mg/kg Specific concentration limits: Skin Irrit. 2; H315: C ≥ 0.025 % Eye Irrit. 2; H319: C ≥ 0.025 % Skin Sens. 1A; H317: C ≥ 0.0015 %	≥0.0025-<0.025%
CAS: 1317-65-3 EINECS: 215-279-6	limestone	≥30-<40%
CAS: 13463-67-7 EINECS: 236-675-5 Index number: 022-006-00-2 Reg.nr.: 01-2119489379-17-XXXX	titanium dioxide substance with a Community workplace exposure limit	≥2-<3%

Additional information:

(CAS:13463-67-7) Titanium dioxide

Note 10: The classification as a carcinogen by inhalation applies only to mixtures in powder form containing 1 % or more of titanium dioxide which is in the form of or incorporated in particles with aerodynamic diameter ≤10 μm.



LAVA 20

Safety Data Sheet

According to Regulation (EC) No. 1907/2006 (REACH) with its Amendment Regulation (EC) No. 1272/2008 (CLP) and EU 2020/878

Printing Date 12. 10. 2023

Version Number 6 (replaces version 5)

Revision: 12. 10. 2023

SECTION 4: First aid measures

4.1 Description of first aid measures

General information:

Symptoms of poisoning may even occur after several hours; therefore medical observation for at least 48 hours after the accident.

Take affected persons out into the fresh air.

Seek immediate medical advice.

After inhalation:

If the patient becomes unconscious, secure him in a side position for transportation.

Get fresh air. Provide artificial respiratory support if necessary. Keep the patient warm.

If symptoms last, see a doctor.

After skin contact:

Wash with soap and water immediately, then thoroughly rinse.

Talk to a doctor if skin irritation persists.

After eye contact:

Rinse the opened eye under flowing water for 15 minutes.

Take off your contact lenses and keep rinsing for a few minutes.

Avoid forceful water jets to prevent corneal injury; consult a doctor.

After swallowing:

Do not force yourself to vomit; instead, contact emergency help right away.

Ensure you are getting lots of fresh air and drink. Make a doctor's appointment immediately.

Seek emergency medical attention.

4.2 Most important symptoms and effects, both acute and delayed

No further relevant information available.

4.3 Indication of any immediate medical attention and special treatment needed

No further relevant information available

SECTION 5: Firefighting measures

5.1 Extinguishing media

Suitable extinguishing agents: CO₂, powder or water spray. Use water spray to put out major fires.

For safety reasons unsuitable extinguishing agents: Water with full jet

5.2 Special hazards arising from the substance or mixture

Carbon dioxide (CO₂)

Carbon monoxide (CO)

5.3 Advice for firefighters

Protective equipment:

Self-contained breathing gear

Full protective clothes are required.

Additional information

Separately collect contaminated fire-fighting water. It should not go down the sewage line.



LAVA 20

Safety Data Sheet

According to Regulation (EC) No. 1907/2006 (REACH) with its Amendment Regulation (EC) No. 1272/2008 (CLP) and EU 2020/878

Printing Date 12. 10. 2023

Version Number 6 (replaces version 5)

Revision: 12. 10. 2023

SECTION 6: Accidental release measures

6.1 Personal precautions, protective equipment and emergency procedures:

Make sure there is enough air circulation.

Stay away from sources of ignition.

Wear safety gear when necessary. Keep vulnerable people at a distance.

6.2 Environmental precautions: Do not allow to enter sewers/ surface or ground water.

6.3 Methods and material for containment and cleaning up:

Utilize absorbent material to collect (sand, diatomite).

Avoid using aqueous cleaning solutions or water to flush.

6.4 Reference to other sections:

See Section 7 for information on safe handling.

See Section 8 for information on personal protection equipment.

See Section 13 for disposal information.

SECTION 7: Handling and storage

7.1 Precautions for safe handling

Make sure the workspace has adequate exhaustion and ventilation.

Wear the appropriate personal protection equipment as necessary. See section 8 for more information on protective gear.

Do not breathe in vapors.

Avoid skin, eyes, and clothing contact.

Information about fire - and explosion protection:

Avoid smoking and keep all combustible materials away.



Safeguard against electrostatic charges.

7.2 Conditions for safe storage, including any incompatibilities

Storage:

Requirements to be met by storerooms and receptacles:

Retain in a cold environment.

Store far from combustible materials

Receptacles should be ventilated.

Further information about storage conditions:

Preserve the container tightly locked.

Safeguard against high temperatures and sunlight.

7.3 Specific end use(s) No further relevant information available.

SECTION 8: Exposure controls/personal protection

8.1 Control parameters

Ingredients with limit values that require monitoring at the workplace:

CAS: 13463-67-7 titanium dioxide

WEL (Great Britain)

Long-term value: 10* 4** mg/m³

*total inhalable **respirable



LAVA 20

Safety Data Sheet

According to Regulation (EC) No. 1907/2006 (REACH) with its Amendment Regulation (EC) No. 1272/2008 (CLP) and EU 2020/878

Printing Date 12. 10. 2023

Version Number 6 (replaces version 5)

Revision: 12. 10. 2023

CAS: 26471-62-5 m-tolylidene diisocyanate

WEL (Great Britain)	Short-term value: 0.07 mg/m ³ Long-term value: 0.02 mg/m ³ Sen; as -NCO
---------------------	---

DNELs

Reaction mass of ethylbenzene, m-xylene and p-xylene | EC: 905-562-9.

Consumers:

Long-term Systemic effect Oral: 1.6 mg/kg bw/d

Long-term Systemic effect By inhalation: 14.8 mg/m³

Long-term Systemic effect Dermal: 108 mg/kg bw/d

Workers:

Long-term Systemic effect By inhalation: 77 mg/ml

Long-term Systemic effect Dermal: 180 mg/kg bw/d

Short-term Local effect By inhalation: 289 mg/ml

Short-term Systemic effect By inhalation: 289 mg/m

PNECs

Reaction mass of ethylbenzene, m-xylene and p-xylene | EC: 905-562-9.

Fresh water: 0,327 mg / l

Marine water: 0.327 mg / l

Freshwater sediments: 12.46 mg / kg

Marine water sediments: 12,46 mg / kg

Soil: 2.31 mg / kg

Sewage treatment plant: 6.58 mg / l

Additional information: The lists valid during the making were used as basis.

8.2 Exposure controls

Individual protection measures, such as personal protective equipment

General protective and hygienic measures:

Avoid food, drink, and feed.

Prior to breaks and after work, wash your hands.

Keep your hands away from your skin and eyes.

Avoid eating, drinking, and smoking while using the product.

Avoid inhaling mists or vapors.

Protective clothes should be kept apart.



LAVA 20

Safety Data Sheet

According to Regulation (EC) No. 1907/2006 (REACH) with its Amendment Regulation (EC) No. 1272/2008 (CLP) and EU 2020/878

Printing Date 12. 10. 2023

Version Number 6 (replaces version 5)

Revision: 12. 10. 2023

Respiratory protection:



In cases of inadequate ventilation, use an appropriate respiratory protection gear. Respiratory protection is necessary while spraying and in poorly ventilated work spaces. For brief durations of labor, a charcoal filter and particle filter A2-P2 (EN529) combination mask or an air-fed mask are advised.

Hand protection



Protective gloves resistant to chemicals (standard EN 374-1)

The material used for the gloves must be waterproof and resistant to the product, substance, or preparation.

No advice for the glove material for the product, preparation, or chemical mixture can be made due to a lack of studies.

Choose the glove material while taking the degradation, diffusion, and penetration rates into account

Material of gloves

Hand protection when handling the product at room temperature:

Butyl rubber - IIR: thickness $\geq 0,5\text{mm}$; breakthrough time $\geq 480\text{min}$.

Fluorinated rubber - FKM: thickness $\geq 0,4\text{mm}$; breakthrough time $\geq 480\text{min}$.

Recommendation: contaminated gloves should be disposed of.

The material used for the gloves must be waterproof and resistant to the product, substance, or preparation.

No advice for the glove material for the product, preparation, or chemical mixture can be made due to a lack of studies. Choose the glove material while taking the degradation, diffusion, and penetration rates into account.

Penetration time of glove material

The determined penetration times according to EN 16523-1:2015 are not performed under practical conditions.

Therefore a maximum wearing time, which corresponds to 50% of the penetration time, is recommended.

Eye/face protection



Safety glasses with side-shields (frame goggles) (e.g. EN 166)

Body protection:



Chemically resistant, protective work clothing (EN 14605) and boots.



LAVA 20

Safety Data Sheet

According to Regulation (EC) No. 1907/2006 (REACH) with its Amendment Regulation (EC) No. 1272/2008 (CLP) and EU 2020/878

Printing Date 12. 10. 2023

Version Number 6 (replaces version 5)

Revision: 12. 10. 2023

SECTION 9: Physical and chemical properties

9.1 Information on basic physical and chemical properties

General Information

Physical state	Liquid Viscous liquid
Colour	Various colours
Odour	Characteristic
Odour threshold	Not determined
Melting point/freezing point	Not determined
Boiling point or initial boiling point and boiling range	130-150 °C (Reaction mass of ethylbenzene and m-xylene and p-xylene)
Flammability	Not applicable
Lower and upper explosion limit Lower Upper	0.8 Vol % Not determined
Flash point	31°C (Pensky-Martens)
Auto-ignition temperature	Product is not selfigniting
Decomposition temperature	Not determined
pH	Not determined
Viscosity Kinematic viscosity at 23 °C Kinematic viscosity	398 s (ISO 2431/Flow time tISO)



LAVA 20

Safety Data Sheet

According to Regulation (EC) No. 1907/2006 (REACH) with its Amendment Regulation (EC) No. 1272/2008 (CLP) and EU 2020/878

Printing Date 12. 10. 2023

Version Number 6 (replaces version 5)

Revision: 12. 10. 2023

Dynamic	Not determined
Solubility Water:	Not miscible Not determined
Partition coefficient n-octanol/water (log value)	Not determined
Vapour pressure	Not determined
Density and/or relative density Density at 20 °C	1.39-1.41 g/cm ³
Relative density	Not determined
Vapour density	Not determined

9.2 Other information

Appearance Form	Viscous liquid
Important information on protection of health and environment, and on safety. Auto-ignition temperature	480 °C (xylene, Reaction mass of ethylbenzene and m-xylene and p-xylene)
Explosive properties	Product is not explosive. However, formation of explosive air/vapour mixtures are possible.
Solvent separation test	<1 % (UN Part III, par. 32.5.1)
Solvent content VOC (EC)	249 g/l



LAVA 20

Safety Data Sheet

According to Regulation (EC) No. 1907/2006 (REACH) with its
Amendment Regulation (EC) No. 1272/2008 (CLP) and EU 2020/878

Printing Date 12. 10. 2023

Version Number 6 (replaces version 5)

Revision: 12. 10. 2023

Cloud point / clarification point Oxidising properties	Not oxidising
Evaporation rate	Not determined

Information with regard to physical hazard classes

Explosives	Void
Flammable gases	Void
Aerosols	Void
Oxidising gases	Void
Gases under pressure	Void
Flammable liquids	Flammable liquid and vapour
Flammable solids	Void
Self-reactive substances and mixtures	Void
Pyrophoric liquids	Void
Pyrophoric solids	Void
Self-heating substances and mixtures	Void
Substances and mixtures, which emit flammable gases in contact with water	Void
Oxidising liquids	Void



LAVA 20

Safety Data Sheet

According to Regulation (EC) No. 1907/2006 (REACH) with its Amendment Regulation (EC) No. 1272/2008 (CLP) and EU 2020/878

Printing Date 12. 10. 2023

Version Number 6 (replaces version 5)

Revision: 12. 10. 2023

Oxidising solids	Void
Organic peroxides	Void
Corrosive to metals	Void
Desensitised explosives	Void

SECTION 10: Stability and reactivity

10.1 Reactivity No further relevant information available.

10.2 Chemical stability

Thermal decomposition / conditions to be avoided Stable at environment temperature.

10.3 Possibility of hazardous reactions No dangerous reactions known.

10.4 Conditions to avoid Avoid heat, sparkles, naked flame or other sources of ignition.

10.5 Incompatible materials No further relevant information available.

10.6 Hazardous decomposition products Carbon monoxide and carbon dioxide

SECTION 11: Toxicological information

11.1 Information on hazard classes as defined in Regulation (EC) No 1272/2008

Acute toxicity Based on available data, the classification criteria are not met.

LD/LC50 values relevant for classification:

Dermal	ATEmix	9,434 mg/kg
Inhalative	ATEmix	35 mg/l

Reaction mass of ethylbenzene and m-xylene and p-xylene

Oral	LD50	4,300 mg/kg (rat)
Inhalative	LC50 (4h)	5,000 ppm (rat) 5,000 ppm (rabbit)



LAVA 20

Safety Data Sheet

According to Regulation (EC) No. 1907/2006 (REACH) with its Amendment Regulation (EC) No. 1272/2008 (CLP) and EU 2020/878

Printing Date 12. 10. 2023

Version Number 6 (replaces version 5)

Revision: 12. 10. 2023

CAS: 26471-62-5 m-tolylidene diisocyanate

Oral	LD50	4,300 mg/kg (rat)
Dermal	LD50	4,130 mg/kg (rat) >9,400 mg/kg (rabbit)

CAS: 64359-81-5 4,5-dichloro-2-octyl-2H-isothiazol-3-one

Oral	LD50	4,300 mg/kg (rat)
Inhalative	LC50/4h (dusts and mists)	567 mg/kg (ATE) 0.16 mg/l (ATE)

Skin corrosion/irritation Causes skin irritation.

Serious eye damage/irritation Causes serious eye irritation.

Respiratory or skin sensitisation

Inhalation may result in symptoms of allergies, asthma, or breathing problems.

Might result in an allergic skin condition.

Germ cell mutagenicity Based on available data, the classification criteria are not met.

Carcinogenicity Based on available data, the classification criteria are not met.

Reproductive toxicity Based on available data, the classification criteria are not met.

STOT-single exposure Based on available data, the classification criteria are not met.

STOT-repeated exposure

STOT Repeated Exposure Category 2

May cause damage to organs through prolonged or repeated exposure.

Aspiration hazard

The product is classified Aspiration toxicity Category 1

May be fatal if swallowed and enters airways.

Additional toxicological information:

Sensitisation Sensitization possible through skin contact

11.2 Information on other hazards

Endocrine disrupting properties None of the ingredients is listed.

SECTION 12: Ecological information

12.1 Toxicity

Aquatic toxicity:

CAS: 26471-62-5 m-tolylidene diisocyanate



LAVA 20

Safety Data Sheet

According to Regulation (EC) No. 1907/2006 (REACH) with its Amendment Regulation (EC) No. 1272/2008 (CLP) and EU 2020/878

Printing Date 12. 10. 2023

Version Number 6 (replaces version 5)

Revision: 12. 10. 2023

EC50 (48h)	12.5 mg/l (daphnia magna)
LC50 (96h)	133 mg/l (Oncorhynchus mykiss)

12.2 Persistence and degradability No further relevant information available.

12.3 Bioaccumulative potential No further relevant information available.

12.4 Mobility in soil No further relevant information available.

12.5 Results of PBT and vPvB assessment

PBT: Not applicable.

vPvB: Not applicable.

12.6 Endocrine disrupting properties For information on endocrine disrupting properties see section 11.

12.7 Other adverse effects

Remark: Harmful to fish

Additional ecological information:

General notes:

Do not allow undiluted product or large quantities of it to reach ground water, water course or sewage system.

The product contains materials that are harmful to the environment.

Harmful to aquatic organisms

SECTION 13: Disposal considerations

13.1 Waste treatment methods

Recommendation



Dispose according to National Regulations.



Must not be disposed together with household garbage. Do not allow product to reach sewage system.

Contact manufacturer for recycling information.

Uncleaned packaging:

Recommendation: Disposal must be made according to official regulations.



LAVA 20

Safety Data Sheet

According to Regulation (EC) No. 1907/2006 (REACH) with its
Amendment Regulation (EC) No. 1272/2008 (CLP) and EU 2020/878

Printing Date 12. 10. 2023

Version Number 6 (replaces version 5)

Revision: 12. 10. 2023

SECTION 14: Transport information

14.1 UN number or ID number ADR, IMDG, IATA	UN1866
14.2 UN proper shipping name ADR IMDG, IATA	1866 RESIN SOLUTION RESIN SOLUTION
14.3 Transport hazard class(es) ADR, IMDG, IATA  Class Label	 3 Flammable liquids. 3
14.4 Packing group ADR, IMDG, IATA	III
14.5 Environmental hazards: Marine pollutant:	No
14.6 Special precautions for user Hazard identification number (Kemler code): EMS Number: Stowage Category	Warning: Flammable liquids. 30 F-E,S-E A
14.7 Maritime transport in bulk according to IMO instruments	Not applicable.



LAVA 20

Safety Data Sheet

According to Regulation (EC) No. 1907/2006 (REACH) with its
Amendment Regulation (EC) No. 1272/2008 (CLP) and EU 2020/878

Printing Date 12. 10. 2023

Version Number 6 (replaces version 5)

Revision: 12. 10. 2023

Transport/Additional information:

ADR Limited quantities (LQ) Excepted quantities (EQ)	5L Code: E1 Maximum net quantity per inner packaging: 30 ml Maximum net quantity per outer packaging: 1000 ml
Transport category	3
Tunnel restriction code	D/E
Remarks	<ul style="list-style-type: none">• Viscous liquid par. 2.2.3.1.5., 2.2.3.1.5.2 ADR and par. 2.3.2.5 of the IMDG Code.• Exception for packages: ≤ 5 liters.- In accordance to paragraphs 2.2.3.1.5, 2.2.3.1.5.2 of ADR (road transport) and 2.3.2.5 of the IMDG Code (marine transport) for packaging ≤ 5 liters (L), are not subject to the ADR agreement and are not subject to the provisions for the marking, labelling and testing of packages (IMDG).
IMDG Limited quantities (LQ) Excepted quantities (EQ)	5L Code: E1 Maximum net quantity per inner packaging: 30 ml Maximum net quantity per outer packaging: 1000 ml
Remarks	<ul style="list-style-type: none">• Viscous liquid par. 2.2.3.1.5., 2.2.3.1.5.2 ADR and par. 2.3.2.5 of the IMDG Code.• Exception for packages: ≤ 5 liters.- In accordance to paragraphs 2.2.3.1.5, 2.2.3.1.5.2 of ADR (road transport) and 2.3.2.5 of the IMDG Code (marine transport) for packaging ≤ 5 liters (L), are not subject to the ADR agreement and are not subject to the provisions for the marking, labelling and testing of packages (IMDG).
UN "Model Regulation"	UN 1866 RESIN SOLUTION, 3, III



LAVA 20

Safety Data Sheet

According to Regulation (EC) No. 1907/2006 (REACH) with its Amendment Regulation (EC) No. 1272/2008 (CLP) and EU 2020/878

Printing Date 12. 10. 2023

Version Number 6 (replaces version 5)

Revision: 12. 10. 2023

SECTION 15: Regulatory information

15.1 Safety, health and environmental regulations/legislation specific for the substance or mixture

REACH Regulation 1907/2006/EC

Regulation (EU) 2020/878

CLP Regulation 1272/2008/EC

Directive 94/62/EC on packaging and packaging waste.

Directive 98/24/EC on the protection of health and safety of workers from the risks related to chemicals agents at work.

Council Directive 94/33/EC on the protection of young people at work, as amended.

Directive 92/85/EEC on the introduction of measures to encourage improvements in the safety and health at work of pregnant workers and workers who have recently given birth or are breastfeeding, as amended

Directive 2012/18/EU

Named dangerous substances - ANNEX I Substance is not listed.

Seveso category P5c FLAMMABLE LIQUIDS

Qualifying quantity (tonnes) for the application of lower-tier requirements 5.000 t

Qualifying quantity (tonnes) for the application of upper-tier requirements 50.000 t

REGULATION (EC) No 1907/2006 ANNEX XVII Conditions of restriction: 3, 74

National regulations:

Other regulations, limitations and prohibitive regulations

Substances of very high concern (SVHC) according to REACH, Article 57

It doesn't contain substances of very high concern (SVHC).

15.2 Chemical safety assessment: A Chemical Safety Assessment has not been carried out.

SECTION 16: Other information

This information is based on our present knowledge. However, this shall not constitute a guarantee for any specific product features and shall not establish a legally valid contractual relationship.

Relevant phrases

H226 Flammable liquid and vapour.

H302 Harmful if swallowed.

H304 May be fatal if swallowed and enters airways.

H312 Harmful in contact with skin.

H314 Causes severe skin burns and eye damage.

H315 Causes skin irritation.

H317 May cause an allergic skin reaction.

H318 Causes serious eye damage.

H319 Causes serious eye irritation.

H330 Fatal if inhaled.

H332 Harmful if inhaled.

H334 May cause allergy or asthma symptoms or breathing difficulties if inhaled.

H335 May cause respiratory irritation.

H351 Suspected of causing cancer.

H373 May cause damage to organs through prolonged or repeated exposure.



LAVA 20

Safety Data Sheet

According to Regulation (EC) No. 1907/2006 (REACH) with its
Amendment Regulation (EC) No. 1272/2008 (CLP) and EU 2020/878

Printing Date 12. 10. 2023

Version Number 6 (replaces version 5)

Revision: 12. 10. 2023

H400 Very toxic to aquatic life.

H410 Very toxic to aquatic life with long lasting effects.

H412 Harmful to aquatic life with long lasting effects.

EUH204 Contains isocyanates. May produce an allergic reaction.

Department issuing SDS

OWL WATERPROOFING SOLUTIONS

135 Slaney Road, Dublin Industrial Estate

Glasnevin, Dublin 11

Tel: +353 01 830 2250

Email: info@owlwaterproofing.co.uk

Website: www.owlwaterproofing.co.uk

Version number of previous version: 5

Abbreviations and acronyms:

ADR: Accord relatif au transport international des marchandises dangereuses par route (European Agreement Concerning the International Carriage of Dangerous Goods by Road)

IMDG: International Maritime Code for Dangerous Goods

IATA: International Air Transport Association

GHS: Globally Harmonised System of Classification and Labelling of Chemicals

EINECS: European Inventory of Existing Commercial Chemical Substances

ELINCS: European List of Notified Chemical Substances

CAS: Chemical Abstracts Service (division of the American Chemical Society)

VOC: Volatile Organic Compounds (USA, EU)

DNEL: Derived No-Effect Level (REACH)

PNEC: Predicted No-Effect Concentration (REACH)

LC50: Lethal concentration, 50 percent

LD50: Lethal dose, 50 percent

PBT: Persistent, Bioaccumulative and Toxic

SVHC: Substances of Very High Concern

vPvB: very Persistent and very Bioaccumulative

Flam. Liq. 3: Flammable liquids – Category 3

Acute Tox. 4: Acute toxicity – Category 4

Acute Tox. 2: Acute toxicity – Category 2

Skin Corr. 1: Skin corrosion/irritation – Category 1

Skin Irrit. 2: Skin corrosion/irritation – Category 2

Eye Dam. 1: Serious eye damage/eye irritation – Category 1

Eye Irrit. 2: Serious eye damage/eye irritation – Category 2

Resp. Sens. 1: Respiratory sensitisation – Category 1

Skin Sens. 1: Skin sensitisation – Category 1

Skin Sens. 1A: Skin sensitisation – Category 1A

Carc. 2: Carcinogenicity – Category 2

STOT SE 3: Specific target organ toxicity (single exposure) – Category 3

STOT RE 2: Specific target organ toxicity (repeated exposure) – Category 2

Asp. Tox. 1: Aspiration hazard – Category 1

Aquatic Acute 1: Hazardous to the aquatic environment - acute aquatic hazard – Category 1

Aquatic Chronic 1: Hazardous to the aquatic environment - long-term aquatic hazard – Category 1

Aquatic Chronic 3: Hazardous to the aquatic environment - long-term aquatic hazard – Category 3

*** Data compared to the previous version altered.**



LAVA 20 VERTICAL

Safety Data Sheet

According to Regulation (EC) No. 1907/2006 (REACH) with its
Amendment Regulation (EC) No. 1272/2008 (CLP) and EU 2020/878

Printing Date 16. 02. 2024

Version Number 6 (replaces version 5)

Revision: 16.02.2024

SECTION 1: Identification of the substance/mixture and of the company/undertaking

1.1 Product identifier

Trade name: LAVA 20 VERTICAL

1.2 Relevant identified uses of the substance or mixture and uses advised against Professional use

Application of the substance / the mixture: Polyurethane Waterproofing Coating

1.3 Details of the supplier of the safety data sheet

Manufacturer/Supplier:

OWL WATERPROOFING SOLUTIONS

135 Slaney Road, Dublin Industrial Estate

Glasnevin, Dublin 11

Tel: +353 01 830 2250

Email: info@owlwaterproofing.co.uk

Website: www.owlwaterproofing.co.uk

1.4 Emergency telephone number:

European Emergency Tel.: +353 01 830 2250

SECTION 2: Hazards identification

2.1 Classification of the substance or mixture

Classification according to Regulation EC No 1272/2008 CLP:

GHS02 flame



Flam. Liq. 3 H226 Flammable liquid and vapour.

GHS08 health hazard



Resp. Sens. 1 H334 May cause allergy or asthma symptoms or breathing difficulties if inhaled.

STOT RE 2 H373 May cause damage to organs through prolonged or repeated exposure.

Asp. Tox. 1 H304 May be fatal if swallowed and enters airways.

GHS07



Skin Irrit. 2 H315 Causes skin irritation.

Eye Irrit. 2 H319 Causes serious eye irritation.

Skin Sens. 1 H317 May cause an allergic skin reaction.

Aquatic Chronic 3 H412 Harmful to aquatic life with long lasting effects.



LAVA 20 VERTICAL

Safety Data Sheet

According to Regulation (EC) No. 1907/2006 (REACH) with its Amendment Regulation (EC) No. 1272/2008 (CLP) and EU 2020/878

Printing Date 16. 02. 2024

Version Number 6 (replaces version 5)

Revision: 16. 02. 2024

2.2 Label elements

Labelling according to Regulation EC No 1272/2008 CLP:

The product is classified and labelled according to the CLP regulation.

Hazard pictograms:



GHS02 GHS08

Signal word: Danger

Hazard-determining components of labelling:

Reaction mass of ethylbenzene and m-xylene and p-xylene
m-tolylidene diisocyanate
4,5-dichloro-2-octyl-2H-isothiazol-3-one

Hazard statements:

H226 Flammable liquid and vapour.
H315 Causes skin irritation.
H319 Causes serious eye irritation.
H334 May cause allergy or asthma symptoms or breathing difficulties if inhaled.
H317 May cause an allergic skin reaction.
H373 May cause damage to organs through prolonged or repeated exposure.
H304 May be fatal if swallowed and enters airways.
H412 Harmful to aquatic life with long lasting effects.

Precautionary statements

P210 Keep away from heat, hot surfaces, sparks, open flames and other ignition sources. No smoking.
P260 Do not breathe dust/fume/gas/mist/vapours/spray.
P280 Wear protective gloves/protective clothing/eye protection/face protection/hearing protection.
P301+P310 IF SWALLOWED: Immediately call a POISON CENTER/ doctor.
P331 Do NOT induce vomiting.
P501 Dispose of contents/container in accordance with local/regional/national/international regulations.

Additional information:

EUH204 Contains isocyanates. May produce an allergic reaction.
EUH211 Warning! Hazardous respirable droplets may be formed when sprayed. Do not breathe spray or mist. Do not breathe spray or mist. As from 24 August 2023 adequate training is required before industrial or professional use.

2.3 Other hazards

Results of PBT and vPvB assessment

The product does not contain ingredients that are considered either persistent, bioaccumulative and toxic (PBT) or very persistent and very bioaccumulative (vPvB) at levels of 0.1% or higher.



LAVA 20 VERTICAL

Safety Data Sheet

According to Regulation (EC) No. 1907/2006 (REACH) with its Amendment Regulation (EC) No. 1272/2008 (CLP) and EU 2020/878

Printing Date 16. 02. 2024

Version Number 6 (replaces version 5)

Revision: 16. 02. 2024

PBT: Not applicable.

vPvB: Not applicable.

Assessment of Endocrine-Disrupting Properties

This product does not contain any substances listed under Article 59(1) of REACH as having endocrine-disrupting properties. Also, it has not been identified as meeting the criteria for endocrine disruption as defined in Commission Delegated Regulation (EU) 2017/2100 or Commission Regulation (EU) 2018/605 at concentrations equal to or exceeding 0.1%.

SECTION 3: Composition/information on ingredients

3.2 Mixtures

Description: Mixture: consisting of the following components.

Ingredients according Regulation (EU) 2020/878:

EC number: 905-562-9 Reg.nr.: 01-2119488216-32-XXXX	Reaction mass of ethylbenzene and m-xylene and p-xylene Flam. Liq. 3, H226; STOT RE 2, H373; Asp. Tox. 1, H304; Acute Tox. 4, H312; Acute Tox. 4, H332; Skin Irrit. 2, H315; Eye Irrit. 2, H319; STOT SE 3, H335; Aquatic Chronic 3, H412 Specific concentration limit: STOT RE 2; H373: C ≥ 10 %	≥ 10 -<25%
CAS: 26471-62-5 EINECS: 247-722-4 Index number: 615-006-00-4 Reg.nr.: 01-2119454791-34-XXXX	m-tolylidene diisocyanate Acute Tox. 2, H330; Resp. Sens. 1, H334; Carc. 2, H351; Skin Irrit. 2, H315; Eye Irrit. 2, H319; Skin Sens. 1, H317; STOT SE 3, H335; Aquatic Chronic 3, H412, EUH204 Specific concentration limit: Resp. Sens. 1; H334: C ≥ 0.1 % substance with a Community workplace exposure limit	≥ 0.1 -<1%
CAS: 64359-81-5 EINECS: 264-843-8 Index number: 613-335-00-8	4,5-dichloro-2-octyl-2H-isothiazol-3-one Acute Tox. 2, H330; Skin Corr. 1, H314; Eye Dam. 1, H318; Aquatic Acute 1, H400 (M=100); Aquatic Chronic 1, H410 (M=100); Acute Tox. 4, H302; Skin Sens. 1A, H317 ATE: LD50 oral: 567 mg/kg Specific concentration limits: Skin Irrit. 2; H315: C ≥ 0.025 %	≥ 0.0025 -<0.025%



LAVA 20 VERTICAL

Safety Data Sheet

According to Regulation (EC) No. 1907/2006 (REACH) with its Amendment Regulation (EC) No. 1272/2008 (CLP) and EU 2020/878

Printing Date 16. 02. 2024

Version Number 6 (replaces version 5)

Revision: 16. 02. 2024

	Eye Irrit. 2; H319: C \geq 0.025 % Skin Sens. 1A; H317: C \geq 0.0015 %	
CAS: 1317-65-3 EINECS: 215-279-6	limestone substance with a Community workplace exposure limit	\geq 25-<35%
CAS: 13463-67-7 EINECS: 236-675-5 Index number: 022-006-00-2 Reg.nr.: 01-2119489379-17-XXXX	titanium dioxide substance with a Community workplace exposure limit	\geq 2.5-<5%

Substances of Very High Concern (SVHC)

This product does not contain any candidate substances of very high concern (SVHC) at concentrations equal to or greater than 0.1%, in compliance with Regulation (EC) No 1907/2006 (REACH), Article 59.

Additional Information:

Titanium dioxide (CAS: 13463-67-7)

Note 10: The classification as a carcinogen by inhalation applies only to mixtures in powder form containing 1% or more of titanium dioxide present in particles with an aerodynamic diameter of \leq 10 μ m.

SECTION 4: First aid measures

4.1 Description of first aid measures

General information:

Medical observation is required for at least 48 hours after the accident since symptoms of poisoning may not show up for several hours.

Allow affected people to get some fresh air. Request medical help immediately.

After inhalation:

If the patient becomes unconscious, secure him in a side position for transportation.

Get fresh air. Provide artificial respiratory support if necessary. Keep the patient warm.

If symptoms last, see a doctor.

After skin contact:

Wash with soap and water immediately, then thoroughly rinse.

Talk to a doctor if skin irritation persists.

Take off any contaminated clothing.

After eye contact:

Rinse the opened eye under flowing water for a few minutes. Consult a doctor if the symptoms continue.

Take off your contact lenses and keep rinsing for a few minutes.

Avoid forceful water jets to prevent corneal injury; consult a doctor.



LAVA 20 VERTICAL

Safety Data Sheet

According to Regulation (EC) No. 1907/2006 (REACH) with its Amendment Regulation (EC) No. 1272/2008 (CLP) and EU 2020/878

Printing Date 16. 02. 2024

Version Number 6 (replaces version 5)

Revision: 16. 02. 2024

After swallowing:

Do not force yourself to vomit; instead, contact emergency help right away.

Ensure you are getting lots of fresh air and drink. Make a doctor's appointment immediately.

Seek emergency medical attention.

Never offer anything by mouth to an unconscious individual.

4.2 Most important symptoms and effects, both acute and delayed

May be fatal if swallowed and enters airways.

4.3 Indication of any immediate medical attention and special treatment needed

If swallowed or in case of vomiting, danger of entering the lungs.

SECTION 5: Firefighting measures

5.1 Extinguishing media

Suitable extinguishing agents: CO₂, powder or water spray. Fight larger fire with foam.

For safety reasons unsuitable extinguishing agents: Water with full jet

5.2 Special hazards arising from the substance or mixture

Carbon dioxide (CO₂)

Carbon monoxide (CO)

5.3 Advice for firefighters

Protective equipment:

In the event of fire, self-contained breathing gear and full protective clothes are required.

Additional information

Separately collect contaminated fire-fighting water. It should not go down the sewage line.

SECTION 6: Accidental release measures

6.1 Personal precautions, protective equipment and emergency procedures:

Make sure there is enough air circulation.

Avoid breathing in fumes.

Avoid Contact with skin and eyes.

Stay away from sources of ignition.

6.1.1 For non-emergency personnel

Stay away from any leaking or flowing substances.

Use personal protective equipment.

6.1.2 For emergency responders

Wear safety gear when necessary. Keep vulnerable people at a distance.

Protective gear, gloves, goggles, and a breathing device with a type A filter are required for first-aid rescuers.

6.2 Environmental precautions: Do not allow to enter sewers/ surface or ground water.

6.3 Methods and material for containment and cleaning up:

Utilize absorbent material to collect (sand, diatomite).

Make sure there is enough airflow.

Place in appropriate containers for salvage or disposal.



LAVA 20 VERTICAL

Safety Data Sheet

According to Regulation (EC) No. 1907/2006 (REACH) with its Amendment Regulation (EC) No. 1272/2008 (CLP) and EU 2020/878

Printing Date 16. 02. 2024

Version Number 6 (replaces version 5)

Revision: 16. 02. 2024

6.4 Reference to other sections:

See Section 7 for information on safe handling.

See Section 8 for information on personal protection equipment.

See Section 13 for disposal information.

SECTION 7: Handling and storage

7.1 Precautions for safe handling

Avoid contact with skin, eyes, and clothing.

Prevent inhalation and ingestion.

Refrain from eating, drinking, or smoking while using this product.

Wash contaminated clothing before reuse.

Thoroughly wash hands after handling.

Information about fire - and explosion protection: Avoid smoking and keep all combustible materials away.

Safeguard against electrostatic charges.

Keep away from ignition sources and avoid smoking.

7.2 Conditions for safe storage, including any incompatibilities

Storage: Store in cool, dry conditions in well sealed receptacles.

Requirements to be met by storerooms and receptacles: Store in a cool place.

Additional Storage Conditions:

Store separately from oxidizing agents.

Additional Storage Conditions:

Ensure containers are tightly sealed.

Keep away from heat and direct sunlight.

7.3 Specific end use(s) No further relevant information available.

SECTION 8: Exposure controls/personal protection

8.1 Control parameters

Ingredients with limit values that require monitoring at the workplace:

CAS: 1317-65-3 limestone

WEL (Great Britain)	Long-term value: 10* 4** mg/m ³ *inhalable dust; **respirable
---------------------	---

CAS: 13463-67-7 titanium dioxide

WEL (Great Britain)	Long-term value: 10* 4** mg/m ³ *total inhalable **respirable
---------------------	---



LAVA 20 VERTICAL

Safety Data Sheet

According to Regulation (EC) No. 1907/2006 (REACH) with its Amendment Regulation (EC) No. 1272/2008 (CLP) and EU 2020/878

Printing Date 16. 02. 2024

Version Number 6 (replaces version 5)

Revision: 16. 02. 2024

CAS: 26471-62-5 m-tolylidene diisocyanate

WEL (Great Britain)	Short-term value: 0.07 mg/m ³ Long-term value: 0.02 mg/m ³ Sen; as -NCO
---------------------	---

DNELs

(EC: 905-562-9) Reaction mass of ethylbenzene, m-xylene and p-xylene

Workers:

Long-term systemic effect, by inhalation: 221 mg/m³

Long-term local effect, by inhalation: 221 mg/m³

Short-term local effect, inhalation: 442 mg/m³

Long-term systemic effect, dermal: 212 mg/kg bw/d

Consumers:

Long-term systemic effect, inhalation: 65.3 mg/m³

Short-term systemic effect, inhalation: 260 mg/m³

Long-term local effect, inhalation: 65.3 mg/m³

Short-term local effect, inhalation: 260 mg/m³

Long-term systemic effect, dermal: 125 mg/kg bw/d

Long-term systemic effect, oral: 12.5 mg/kg bw/d

PNECs

(EC: 905-562-9) reaction mass of ethylbenzene and m-xylene and p-xylene

Fresh water: 0.044 mg/l

Fresh water (intermittent releases): 0.01 mg/l

Marine water: 0.004 mg/l

STP: 1.6 mg/l

Freshwater sediment: 2.52 mg/kg of sediment dw

Marine water sediment: 0.252 mg/kg sediment dw

Soil: 0.852 mg/kg

8.2 Exposure Controls

8.2.1. Appropriate Engineering Controls Ensure adequate ventilation is provided.

Personal Protection Measures, Including PPE

General Protective and Hygiene Measures:

Keep away from food, drinks, and animal feed.

Wash hands before breaks and after finishing work.

Avoid contact with eyes and skin.



LAVA 20 VERTICAL

Safety Data Sheet

According to Regulation (EC) No. 1907/2006 (REACH) with its Amendment Regulation (EC) No. 1272/2008 (CLP) and EU 2020/878

Printing Date 16. 02. 2024

Version Number 6 (replaces version 5)

Revision: 16. 02. 2024

Do not eat, drink, or smoke while handling the product.

Prevent inhalation and ingestion.

Remove and wash contaminated clothing before reuse.

Respiratory Protection:



Use appropriate respiratory protective equipment if ventilation is insufficient. Respiratory protection is necessary in poorly ventilated areas and during spraying. An air-fed mask is recommended, or for short-term tasks, a combination of a charcoal filter and particulate filter A2-P2 (EN529).

Hand Protection:



Use chemical-resistant protective gloves (standard EN 374-1). Gloves should be impermeable and resistant to the specific product, substance, or mixture. Choose glove material based on penetration times, diffusion rates, and degradation.

Glove Material:

For handling at room temperature: Butyl rubber (IIR) with a thickness of $\geq 0.5\text{mm}$ and a breakthrough time of ≥ 480 minutes. Fluorinated rubber (FKM) with a thickness of $\geq 0.4\text{mm}$ and a breakthrough time of ≥ 480 minutes.

Recommendation: Dispose of contaminated gloves.

Glove Selection:

Suitable gloves should be chosen not only based on material but also on quality markers, which can vary between manufacturers. As the product contains a mix of substances, the resistance of glove materials cannot be predetermined and should be verified before use.

Penetration Time of Glove Material: ≥ 480 minutes. The penetration times determined according to EN 16523-1:2015 are not based on real-world conditions. Therefore, a maximum wear time of 50% of the penetration time is recommended.

Eye/Face Protection:



Use safety glasses with side-shields (e.g., frame goggles, standard EN 166).

Body Protection:



Wear chemical-resistant protective clothing (EN 14605) and boots.



LAVA 20 VERTICAL

Safety Data Sheet

According to Regulation (EC) No. 1907/2006 (REACH) with its Amendment Regulation (EC) No. 1272/2008 (CLP) and EU 2020/878

Printing Date 16. 02. 2024

Version Number 6 (replaces version 5)

Revision: 16. 02. 2024

SECTION 9: Physical and chemical properties

9.1 Information on basic physical and chemical properties

General Information

Physical state	Viscous liquid
Colour:	Various colours
Odour:	Light
Odour threshold:	Not determined
Melting point/freezing point:	Not determined
Flammability	Flammable.
Lower and upper explosion limit Lower: Upper:	Not determined Not determined
Flash point:	31 °C (ASTM D93)
Auto-ignition temperature:	488 °C
Decomposition temperature:	Not determined
pH	Not determined
Viscosity: Dynamic:	Not determined
Solubility water:	Not miscible
Partition coefficient n-octanol/water (log value)	Not determined



LAVA 20 VERTICAL

Safety Data Sheet

According to Regulation (EC) No. 1907/2006 (REACH) with its Amendment Regulation (EC) No. 1272/2008 (CLP) and EU 2020/878

Printing Date 16. 02. 2024

Version Number 6 (replaces version 5)

Revision: 16. 02. 2024

Vapour pressure:	Not determined
Density and/or relative density Density at 20 °C: Relative density Vapour density	1.34-1.35 g/cm ³ Not determined Not determined
9.2 Other information	
Appearance: Form:	Viscous liquid
Important information on protection of health and environment, and on safety.	
Ignition temperature:	Product is not selfigniting.
Explosive properties:	Product is not explosive. However, formation of explosive air/vapour mixtures are possible.
Solvent separation test:	<1 % (UN Part III, par. 32.5.1)
Solvent content: VOC (EC)	262 g/l
Setting temperature / range: Oxidising properties	Not classified as an oxidizer according to CLP Regulation 1272/2008/EC.
Evaporation rate	Not determined
Information with regard to physical hazard classes	
Explosives	Void
Flammable gases	Void



LAVA 20 VERTICAL

Safety Data Sheet

According to Regulation (EC) No. 1907/2006 (REACH) with its Amendment Regulation (EC) No. 1272/2008 (CLP) and EU 2020/878

Printing Date 16. 02. 2024

Version Number 6 (replaces version 5)

Revision: 16. 02. 2024

Aerosols	Void
Oxidising gases	Void
Gases under pressure	Void
Flammable liquids	Flammable liquid and vapour.
Flammable solids	Void
Self-reactive substances and mixtures	Void
Pyrophoric liquids	Void
Pyrophoric solids	Void
Self-heating substances and mixtures	Void
Substances and mixtures, which emit flammable gases in contact with water	Void
Oxidising liquids	Void
Oxidising solids	Void
Organic peroxides	Void
Corrosive to metals	Void
Desensitised explosives	Void



LAVA 20 VERTICAL

Safety Data Sheet

According to Regulation (EC) No. 1907/2006 (REACH) with its Amendment Regulation (EC) No. 1272/2008 (CLP) and EU 2020/878

Printing Date 16. 02. 2024

Version Number 6 (replaces version 5)

Revision: 16. 02. 2024

SECTION 10: Stability and reactivity

10.1 Reactivity Stable under standard conditions.

10.2 Chemical Stability The material remains stable under normal conditions.

Thermal Decomposition/Conditions to Avoid:

To prevent thermal decomposition, avoid excessive heating. Stable at ambient temperatures.

10.3 Possibility of Hazardous Reactions No known dangerous reactions.

10.4 Conditions to Avoid Keep away from heat, sparks, open flames, and other ignition sources.

10.5 Incompatible Materials Oxidizing agents.

10.6 Hazardous Decomposition Products May produce carbon monoxide (CO) and carbon dioxide (CO₂).

SECTION 11: Toxicological information

11.1 Information on hazard classes as defined in Regulation (EC) No 1272/2008

Acute toxicity Based on available data, the classification criteria are not met.

LD/LC50 values relevant for classification:

ATE (Acute Toxicity Estimates)

Inhalative	LC50/4 h (vapour)	107 mg/l
------------	-------------------	----------

Reaction mass of ethylbenzene and m-xylene and p-xylene

Oral	LD50	>3,523 mg/kg (rat)
Dermal	LD50	>12,126 mg/kg (rabbit)
Inhalative	LC50/4 h (vapour)	>27 mg/l (rat)

CAS: 13463-67-7 titanium dioxide

Oral	LD50	>5,000 mg/kg (rat)
Inhalative	LC50/4 h (vapour)	>6.82 mg/l (rat)

CAS: 26471-62-5 m-tolyldiene diisocyanate

Oral	LD50	>2,000 mg/kg (rat) (Acute Oral Toxicity)
Dermal	LD50	>2,000 mg/kg (rabbit) (Acute Dermal Toxicity)
Inhalative	LC50/4 h (vapour)	0.107 mg/l (rat)



LAVA 20 VERTICAL

Safety Data Sheet

According to Regulation (EC) No. 1907/2006 (REACH) with its Amendment Regulation (EC) No. 1272/2008 (CLP) and EU 2020/878

Printing Date 16. 02. 2024

Version Number 6 (replaces version 5)

Revision: 16. 02. 2024

CAS: 64359-81-5 4,5-dichloro-2-octyl-2H-isothiazol-3-one

Oral	LD50	567 mg/kg (ATE)
Inhalative	LC50/4h (dusts and mists)	0.16 mg/l

Skin Corrosion/Irritation: Causes irritation to the skin.

Serious Eye Damage/Irritation: Leads to significant eye irritation.

Respiratory or Skin Sensitization:

May cause allergy or asthma symptoms or breathing difficulties upon inhalation.

May trigger an allergic skin reaction.

Germ Cell Mutagenicity: Current data does not meet classification criteria for germ cell mutagenicity.

Carcinogenicity: Based on available data, the product does not meet classification criteria for carcinogenicity.

Reproductive Toxicity: The product is not classified for reproductive toxicity.

STOT - Single Exposure: Does not meet classification criteria based on existing data.

STOT - Repeated Exposure:

Classified under Specific Target Organ Toxicity (Category 2) for repeated exposure.

May cause organ damage with prolonged or repeated exposure.

Aspiration Hazard:

Classified under Aspiration Toxicity (Category 1).

May be fatal if swallowed and enters the respiratory tract.

Additional Toxicological Information:

Sensitization: Skin contact may lead to sensitization.

11.2 Information on Other Hazards

Endocrine Disrupting Properties:

The product contains no substances listed in accordance with Article 59(1) of REACH as endocrine disruptors, nor does it meet the criteria for endocrine-disrupting properties as per Commission Delegated Regulation (EU) 2017/2100 or Commission Regulation (EU) 2018/605 at concentrations of 0.1% or higher.

None of the ingredients are listed.

SECTION 12: Ecological information

12.1 Toxicity

Aquatic toxicity:

Reaction mass of ethylbenzene and m-xylene and p-xylene

EC50 (72h)	4.6-4.9 mg/l (algae)
EC50 (48h)	10.389 mg/l (Daphnia magna)
LC50 (96h)	>2.6 mg/l (fish)



LAVA 20 VERTICAL

Safety Data Sheet

According to Regulation (EC) No. 1907/2006 (REACH) with its Amendment Regulation (EC) No. 1272/2008 (CLP) and EU 2020/878

Printing Date 16. 02. 2024

Version Number 6 (replaces version 5)

Revision: 16. 02. 2024

CAS: 13463-67-7 titanium dioxide

EC50 (72h)	100 mg/l (algae)
EC50 (48h)	2.41-103.9 mg/l (Daphnia magna)
LC50 (96h)	1 mg/l (fish)
NOEC(72h)	100 mg/l (algae)
NOEC (21d)	5 mg/l (Daphnia magna)
NOEC (14d)	0.87-1.1 mg/l (fish)

CAS: 26471-62-5 m-tolyldiene diisocyanate

EC50 (72h)	3,230 mg/l (algae)
EC50 (48h)	12.5 mg/l (daphnia magna)
LC50 (96h)	133 mg/l (fish)

12.2 Persistence and Degradability No additional relevant information is available.

12.3 Bioaccumulative Potential No further information is available.

12.4 Mobility in Soil No relevant data available.

12.5 PBT and vPvB Assessment

The product does not contain ingredients classified as persistent, bioaccumulative, and toxic (PBT) or as very persistent and very bioaccumulative (vPvB) at concentrations of 0.1% or more, as per REACH, Annex XIII.

PBT: Not applicable

vPvB: Not applicable

12.6 Endocrine Disrupting Properties

The product does not contain substances listed under Article 59(1) of REACH as endocrine disruptors and has not been identified as having endocrine-disrupting properties based on the criteria in Commission Delegated Regulation (EU) 2017/2100 or Commission Regulation (EU) 2018/605 at levels of 0.1% or higher.

12.7 Other Adverse Effects

Remark: Harmful to fish



LAVA 20 VERTICAL

Safety Data Sheet

According to Regulation (EC) No. 1907/2006 (REACH) with its Amendment Regulation (EC) No. 1272/2008 (CLP) and EU 2020/878

Printing Date 16. 02. 2024

Version Number 6 (replaces version 5)

Revision: 16. 02. 2024

Additional Ecological Information: The product contains components harmful to the environment and aquatic life. Avoid releasing undiluted product or large quantities into groundwater, water bodies, or sewage systems.

SECTION 13: Disposal considerations

13.1 Waste treatment methods

Recommendation

Dispose according to National Regulations.

Not to be disposed of with regular trash. Do not let product enter the drainage system.



Contact manufacturer for recycling information.

European Waste Catalogue

- HP3: Flammable
- HP5: Specific Target Organ Toxicity (STOT) / Aspiration Toxicity
- HP14: Ecotoxic

Uncleaned packaging:

Recommendation:

Official guidelines must be followed while disposing of materials.

After cleaning, packaging can be recycled or used again.

SECTION 14: Transport information

14.1 UN number or ID number ADR, IMDG, IATA	UN1866
14.2 UN proper shipping name ADR IMDG, IATA	1866 RESIN SOLUTION RESIN SOLUTION
14.3 Transport hazard class(es) ADR, IMDG, IATA  Class Label	3 Flammable liquids. 3
14.4 Packing group ADR, IMDG, IATA	III



LAVA 20 VERTICAL

Safety Data Sheet

According to Regulation (EC) No. 1907/2006 (REACH) with its Amendment Regulation (EC) No. 1272/2008 (CLP) and EU 2020/878

Printing Date 16. 02. 2024

Version Number 6 (replaces version 5)

Revision: 16. 02. 2024

14.5 Environmental hazards: Marine pollutant:	No
14.6 Special precautions for user	Warning: Flammable liquids.
Hazard identification number (Kemler code):	30
EMS Number:	F-E, <u>S-E</u>
Stowage Category	A
14.7 Maritime transport in bulk according to IMO instruments	Not applicable.
Transport/Additional information:	
ADR Limited quantities (LQ) Excepted quantities (EQ)	5L Code: E1 Maximum net quantity per inner packaging: 30 ml Maximum net quantity per outer packaging: 1000 ml
Transport category	3
Tunnel restriction code	D/E
IMDG Limited quantities (LQ) Excepted quantities (EQ)	5 L Code: E1 Maximum net quantity per inner packaging: 30 ml Maximum net quantity per outer packaging: 1000 ml
UN "Model Regulation"	UN 1866 RESIN SOLUTION, 3, III



LAVA 20 VERTICAL

Safety Data Sheet

According to Regulation (EC) No. 1907/2006 (REACH) with its Amendment Regulation (EC) No. 1272/2008 (CLP) and EU 2020/878

Printing Date 16. 02. 2024

Version Number 6 (replaces version 5)

Revision: 16. 02. 2024

SECTION 15: Regulatory information

15. Regulatory Information

15.1 Safety, Health, and Environmental Regulations/Legislation Specific to the Substance or Mixture

This product is regulated under the following EU legislation:

REACH Regulation (EC) No. 1907/2006, Regulation (EU) 2020/878, CLP Regulation (EC) No. 1272/2008 Directive 98/24/EC – Protection of workers from chemical risks, Directive 94/33/EC – Protection of young, people at work (as amended), Directive 92/85/EEC – Safety and health measures for pregnant and breastfeeding workers (as amended), Directive 2012/18/EU (Seveso III Directive)

Seveso Classification:

Category: P5c – Flammable Liquids

Threshold quantities:

Lower-tier: 5,000 tonnes

Upper-tier: 50,000 tonnes

Annex I – Dangerous Substances: The substance is not listed in Annex I.

REACH Annex XVII Restrictions: Subject to the following restrictions: 3, 52a, 74

Directive 2011/65/EU (RoHS): No components are listed in Annex II restricting hazardous substances in electrical and electronic equipment.

Regulation (EU) 2019/1148 on Explosives Precursors:

Annex I – Restricted precursors: None of the ingredients are listed.

Annex II – Reportable precursors: None of the ingredients are listed.

Drug Precursor Regulations:

Regulation (EC) No. 273/2004: No ingredients listed

Regulation (EC) No. 111/2005: No ingredients listed

National Regulations: No additional national regulations reported.

SVHC (Substances of Very High Concern) under REACH Article 57: This product does not contain any SVHC substances.

15.2 Chemical Safety Assessment: A chemical safety assessment has not been conducted for this product.

SECTION 16: Other information

This information is based on our present knowledge. However, this shall not constitute a guarantee for any specific product features and shall not establish a legally valid contractual relationship.

Relevant phrases

H226 Flammable liquid and vapour.

H302 Harmful if swallowed.

H304 May be fatal if swallowed and enters airways.

H312 Harmful in contact with skin.

H314 Causes severe skin burns and eye damage.

H315 Causes skin irritation.

H317 May cause an allergic skin reaction.



LAVA 20 VERTICAL

Safety Data Sheet

According to Regulation (EC) No. 1907/2006 (REACH) with its Amendment Regulation (EC) No. 1272/2008 (CLP) and EU 2020/878

Printing Date 16. 02. 2024

Version Number 6 (replaces version 5)

Revision: 16. 02. 2024

H318 Causes serious eye damage.

H319 Causes serious eye irritation.

H330 Fatal if inhaled.

H332 Harmful if inhaled.

H334 May cause allergy or asthma symptoms or breathing difficulties if inhaled.

H335 May cause respiratory irritation.

H351 Suspected of causing cancer.

H373 May cause damage to organs through prolonged or repeated exposure.

H400 Very toxic to aquatic life.

H410 Very toxic to aquatic life with long lasting effects.

H412 Harmful to aquatic life with long lasting effects.

EUH204 Contains isocyanates. May produce an allergic reaction.

Training hints

Suitable training on safety in handling, storing and converting the product should be given to the employees based on all the existing information.

Version number of previous version: 4

Abbreviations and acronyms:

ADR: Accord relatif au transport international des marchandises dangereuses par route (European Agreement Concerning the International Carriage of Dangerous Goods by Road)

IMDG: International Maritime Code for Dangerous Goods

IATA: International Air Transport Association

GHS: Globally Harmonised System of Classification and Labelling of Chemicals

EINECS: European Inventory of Existing Commercial Chemical Substances

ELINCS: European List of Notified Chemical Substances

CAS: Chemical Abstracts Service (division of the American Chemical Society)

VOC: Volatile Organic Compounds (USA, EU)

DNEL: Derived No-Effect Level (REACH)

PNEC: Predicted No-Effect Concentration (REACH)

LC50: Lethal concentration, 50 percent

LD50: Lethal dose, 50 percent

PBT: Persistent, Bioaccumulative and Toxic

SVHC: Substances of Very High Concern

vPvB: very Persistent and very Bioaccumulative

Flam. Liq. 3: Flammable liquids – Category 3

Acute Tox. 4: Acute toxicity – Category 4

Acute Tox. 2: Acute toxicity – Category 2

Skin Corr. 1: Skin corrosion/irritation – Category 1

Skin Irrit. 2: Skin corrosion/irritation – Category 2

Eye Dam. 1: Serious eye damage/eye irritation – Category 1

Eye Irrit. 2: Serious eye damage/eye irritation – Category 2

Resp. Sens. 1: Respiratory sensitisation – Category 1

Skin Sens. 1: Skin sensitisation – Category 1

Skin Sens. 1A: Skin sensitisation – Category 1A

Carc. 2: Carcinogenicity – Category 2

STOT SE 3: Specific target organ toxicity (single exposure) – Category 3

STOT RE 2: Specific target organ toxicity (repeated exposure) – Category 2

Asp. Tox. 1: Aspiration hazard – Category 1

Aquatic Acute 1: Hazardous to the aquatic environment - acute aquatic hazard – Category 1

Aquatic Chronic 1: Hazardous to the aquatic environment - long-term aquatic hazard – Category 1

Aquatic Chronic 3: Hazardous to the aquatic environment - long-term aquatic hazard – Category 3

* Data compared to the previous version altered.



LAVA DETAIL 20

Safety Data Sheet

According to Regulation (EC) No. 1907/2006 (REACH) with its
Amendment Regulation (EC) No. 1272/2008 (CLP) and EU 2020/878

Printing Date 12. 11. 2025

Version Number 10 (replaces version 9)

Revision: 12. 11. 2025

SECTION 1: Identification of the substance/mixture and of the company/undertaking

1.1 Product identifier

Trade name: LAVA DETAIL 20

UFI: A361-W0GX-F00W-KM90

1.2 Relevant identified uses of the substance or mixture and uses advised against Professional use

Application of the substance / the mixture: Waterproofing Coating

1.3 Details of the supplier of the safety data sheet

Manufacturer/Supplier:

OWL WATERPROOFING SOLUTIONS

135 Slaney Road, Dublin Industrial Estate

Glasnevin, Dublin 11

Tel: +353 01 830 2250

Email: info@owlwaterproofing.co.uk

Website: www.owlwaterproofing.co.uk

1.4 Emergency telephone number:

European Emergency Tel.: +353 01 830 2250

SECTION 2: Hazards identification

2.1 Classification of the substance or mixture

Classification according to Regulation EC No 1272/2008 CLP:

GHS02 flame



Flam. Liq. 3 H226 Flammable liquid and vapour.

GHS08 health hazard



Resp. Sens. 1 H334 May cause allergy or asthma symptoms or breathing difficulties if inhaled.

STOT RE 2 H373 May cause damage to organs through prolonged or repeated exposure.

Asp. Tox. 1 H304 May be fatal if swallowed and enters airways.

GHS07



Skin Irrit. 2 H315 Causes skin irritation.

Eye Irrit. 2 H319 Causes serious eye irritation.

Skin Sens. 1 H317 May cause an allergic skin reaction.

Aquatic Chronic 3 H412 Harmful to aquatic life with long lasting effects.



LAVA DETAIL 20

Safety Data Sheet

According to Regulation (EC) No. 1907/2006 (REACH) with its Amendment Regulation (EC) No. 1272/2008 (CLP) and EU 2020/878

Printing Date 12. 11. 2025

Version Number 10 (replaces version 9)

Revision: 12. 11. 2025

2.2 Label elements

Labelling according to Regulation EC No 1272/2008 CLP:

The product is classified and labelled according to the CLP regulation.

Hazard pictograms:



GHS02

GHS08

Signal word: Danger

Hazard-determining components of labelling:

Reaction mass of ethylbenzene and m-xylene and p-xylene

m-tolylidene diisocyanate

4,5-dichloro-2-octyl-2H-isothiazol-3-one

Hazard statements:

H226 Flammable liquid and vapour.

H315 Causes skin irritation.

H319 Causes serious eye irritation.

H334 May cause allergy or asthma symptoms or breathing difficulties if inhaled.

H317 May cause an allergic skin reaction.

H373 May cause damage to organs through prolonged or repeated exposure.

H304 May be fatal if swallowed and enters airways.

H412 Harmful to aquatic life with long lasting effects.

Precautionary statements

P210 Keep away from heat, hot surfaces, sparks, open flames and other ignition sources. No smoking.

P260 Do not breathe dust/fume/gas/mist/vapours/spray.

P280 Wear protective gloves/protective clothing/eye protection/face protection/hearing protection.

P302+P352 IF ON SKIN: Wash with plenty of water and soap.

P331 Do NOT induce vomiting.

P501 Dispose of contents/container in accordance with local/regional/national/international regulations.

Additional information:

EUH204 Contains isocyanates. May produce an allergic reaction.

As from 24 August 2023 adequate training is required before industrial or professional use.

The synthetic polymer microparticles supplied are subject to conditions laid down by entry 78 of Annex XVII to Regulation (EC) No 1907/2006 of the European Parliament and of the Council.

2.3 Other hazards

Results of PBT and vPvB assessment



LAVA DETAIL 20

Safety Data Sheet

According to Regulation (EC) No. 1907/2006 (REACH) with its Amendment Regulation (EC) No. 1272/2008 (CLP) and EU 2020/878

Printing Date 12. 11. 2025

Version Number 10 (replaces version 9)

Revision: 12. 11. 2025

The product does not contain ingredients that are considered either persistent, bioaccumulative and toxic (PBT) or very persistent and very bioaccumulative (vPvB) at levels of 0.1% or higher.

PBT: Not applicable.

vPvB: Not applicable.

Determination of endocrine-disrupting properties

The product does not contain substances included in the list established in accordance with Article 59(1) of REACH for endocrine disrupting properties or has not been identified as having endocrine disrupting properties according to the criteria set out in Commission Delegated Regulation (EU) 2017/2100 or Commission Regulation (EU) 2018/605 at a concentration equal to or higher than 0.1%.

SECTION 3: Composition/information on ingredients

3.2 Mixtures

Description: Mixture: consisting of the following components.

Ingredients according Regulation (EU) 2020/878:

EC number: 905-562-9 Reg.nr.: 01- 2119488216-32-XXXX	Reaction mass of ethylbenzene and m-xylene and pxylyene Flam. Liq. 3, H226; STOT RE 2, H373; Asp. Tox. 1, H304; Acute Tox. 4, H312; Acute Tox. 4, H332; Skin Irrit. 2, H315; Eye Irrit. 2, H319; STOT SE 3, H335; Aquatic Chronic 3, H412 Specific concentration limit: STOT RE 2; H373: C ≥ 10 %	≥10-<25%
CAS: 26471-62-5 EINECS: 247-722-4 Index number: 615-006-00-4 Reg.nr.: 01- 2119454791-34-XXXX	m-tolyldiene diisocyanate Acute Tox. 2, H330; Resp. Sens. 1, H334; Carc. 2, H351; Skin Irrit. 2, H315; Eye Irrit. 2, H319; Skin Sens. 1, H317; STOT SE 3, H335; Aquatic Chronic 3, H412, EUH204 Specific concentration limit: Resp. Sens. 1; H334: C ≥ 0.1 % substance with a Community workplace exposure limit	≥0.1-<1%
CAS: 64359-81-5 EINECS: 264-843-8 Index number: 613-335-00-8	4,5-dichloro-2-octyl-2H-isothiazol-3-one Acute Tox. 2, H330; Skin Corr. 1, H314; Eye Dam. 1, H318; Aquatic Acute 1, H400 (M=100); Aquatic Chronic 1, H410 (M=100); Acute Tox. 4, H302; Skin Sens. 1A, H317	≥0.0025-<0.025%



LAVA DETAIL 20

Safety Data Sheet

According to Regulation (EC) No. 1907/2006 (REACH) with its Amendment Regulation (EC) No. 1272/2008 (CLP) and EU 2020/878

Printing Date 12. 11. 2025

Version Number 10 (replaces version 9)

Revision: 12. 11. 2025

	ATE: LD50 oral: 567 mg/kg Specific concentration limits: Skin Irrit. 2; H315: C \geq 0.025 % Eye Irrit. 2; H319: C \geq 0.025 % Skin Sens. 1A; H317: C \geq 0.0015 %	
CAS: 1317-65-3 EINECS: 215-279-6	limestone substance with a Community workplace exposure limit	\geq 30-<35%
CAS: 28553-12-0 EINECS: 249-079-5 Reg.nr.: 01- 2119430798-28-XXXX	diisononyl phthalate substance with a Community workplace exposure limit	\geq 2.5-<5%
CAS: 13463-67-7 EINECS: 236-675-5 Index number: 022-006- 00-2 Reg.nr.: 01- 2119489379-17-XXXX	titanium dioxide substance with a Community workplace exposure limit	\geq 2.5-<3%

SVHC Statement:

This product does not contain any substances identified as candidates for very high concern (SVHC) at concentrations of 0.1% or more, in accordance with Regulation (EC) No 1907/2006 (REACH), Article 59.

Additional Information:

Titanium dioxide (CAS: 13463-67-7)

Note 10: The inhalation carcinogen classification only applies to mixtures in powder form that contain 1% or more of titanium dioxide particles with an aerodynamic diameter of \leq 10 μ m.

For the detailed wording of hazard phrases, please refer to Section 16.

SECTION 4: First aid measures

4.1 First Aid Measures

General Information:

Move affected individuals to fresh air immediately. Seek prompt medical assistance.

Inhalation:

Provide fresh air. Always consult a doctor. If the person is unconscious, place them in a stable side position for safe transport.



LAVA DETAIL 20

Safety Data Sheet

According to Regulation (EC) No. 1907/2006 (REACH) with its Amendment Regulation (EC) No. 1272/2008 (CLP) and EU 2020/878

Printing Date 12. 11. 2025

Version Number 10 (replaces version 9)

Revision: 12. 11. 2025

Skin Contact:

Wash the skin thoroughly with soap and water. Rinse completely. If irritation persists, seek medical advice.

Eye Contact:

Rinse eyes thoroughly with plenty of water, lifting both upper and lower eyelids intermittently. Remove contact lenses, if applicable, and continue rinsing for at least 15 minutes. Seek medical help if irritation occurs. Avoid using strong water jets, as they may cause corneal damage—consult a doctor.

Ingestion:

Do not induce vomiting. Contact medical assistance immediately. Drink plenty of water and get fresh air. Consult a doctor immediately and present the product label or Safety Data Sheet.

4.2 Important Symptoms and Effects (Acute and Delayed)

No additional relevant information available.

4.3 Need for Immediate Medical Attention and Special Treatment

No further relevant information available.

SECTION 5: Firefighting measures

5.1 Extinguishing media

Suitable extinguishing agents: CO₂, powder or water spray.

For safety reasons unsuitable extinguishing agents: Water with full jet

5.2 Special hazards arising from the substance or mixture

Carbon monoxide (CO)

Carbon dioxide (CO₂)

5.3 Advice for firefighters

Protective equipment:

Mouth respiratory protective device.

Wear fully protective suit.

Additional information

Collect contaminated fire fighting water separately. It must not enter the sewage system.

SECTION 6: Accidental release measures

6.1 Personal Precautions, Protective Equipment, and Emergency Procedures:

Use appropriate protective gear. Keep those without protection at a safe distance.

Avoid skin and eye contact.

Prevent inhalation of vapors.

Wear protective clothing and ensure sources of ignition are kept away.

6.1.1 For Non-Emergency Personnel:

Avoid contact with any leaking or spilled material.

6.1.2 For Emergency Responders:

First aid responders should be equipped with protective clothing, gloves, goggles, and respirators.

6.2 Environmental Precautions:

Prevent the product from entering drains, surface water, or groundwater systems.



LAVA DETAIL 20

Safety Data Sheet

According to Regulation (EC) No. 1907/2006 (REACH) with its Amendment Regulation (EC) No. 1272/2008 (CLP) and EU 2020/878

Printing Date 12. 11. 2025

Version Number 10 (replaces version 9)

Revision: 12. 11. 2025

6.3 Methods and Materials for Containment and Cleanup:

Use absorbent materials such as sand or diatomite to collect the spill.

6.4 Reference to Other Sections:

For details on safe handling, refer to Section 7.

For information on personal protective equipment, see Section 8.

For disposal instructions, refer to Section 13.

SECTION 7: Handling and storage

7.1 Safe Handling Precautions

Ensure proper ventilation or exhaust at the workplace.

Avoid direct contact with skin and eyes.

Do not eat, drink, or smoke while handling this product.

Wash hands thoroughly after use.

Contaminated clothing should be cleaned before reuse.

Fire and Explosion Protection:

Keep ignition sources at a distance – no smoking.

Prevent the build-up of electrostatic charges.



7.2 Safe Storage Conditions and Incompatibilities

Storage: Store in tightly sealed containers in a well-ventilated area. Keep the storage area cool.

Storage Room and Container Requirements:

Maintain a cool storage environment.

Storage Compatibility:

Store away from oxidizing agents.

Additional Storage Information:

Ensure containers are tightly closed.

Protect from heat and direct sunlight.

7.3 Specific End Uses

No additional relevant information available.

SECTION 8: Exposure controls/personal protection

8.1 Control parameters

Ingredients with limit values that require monitoring at the workplace:

CAS: 1317-65-3 limestone

WEL (Great Britain)	Long-term value: 10* 4** mg/m ³ *inhalable dust; **respirable
---------------------	---

CAS: 28553-12-0 diisononyl phthalate

WEL (Great Britain)	Long-term value: 5 mg/m ³
---------------------	--------------------------------------



LAVA DETAIL 20

Safety Data Sheet

According to Regulation (EC) No. 1907/2006 (REACH) with its
Amendment Regulation (EC) No. 1272/2008 (CLP) and EU 2020/878

Printing Date 12. 11. 2025

Version Number 10 (replaces version 9)

Revision: 12. 11. 2025

CAS: 13463-67-7 titanium dioxide

WEL (Great Britain)	Long-term value: 10* 4** mg/m ³ *total inhalable **respirable
---------------------	---

CAS: 26471-62-5 m-tolyldene diisocyanate

WEL (Great Britain)	Short-term value: 0.07 mg/m ³ Long-term value: 0.02 mg/m ³ Sen; as -NCO
---------------------	---

DNELs

(EC: 905-562-9) Reaction mass of ethylbenzene, m-xylene and p-xylene

Workers:

Long-term systemic effect, by inhalation: 221 mg/m³

Long-term local effect, by inhalation: 221 mg/m³

Short-term local effect, inhalation: 442 mg/m³

Long-term systemic effect, dermal: 212 mg/kg bw/d

Consumers:

Long-term systemic effect, inhalation: 65.3 mg/m³

Short-term systemic effect, inhalation: 260 mg/m³

Long-term local effect, inhalation: 65.3 mg/m³

Short-term local effect, inhalation: 260 mg/m³

Long-term systemic effect, dermal: 125 mg/kg bw/d

Long-term systemic effect, oral: 12.5 mg/kg bw/d

(CAS: 13463-67-7) Titanium dioxide

Employees:

Inhalation - Local effects, Long-term exposure: 1.25 mg/m³

Consumers:

Inhalation - Local effects, Long-term exposure: 210 µg/m³

PNECs

(EC: 905-562-9) reaction mass of ethylbenzene and m-xylene and p-xylene

Fresh water: 0.044 mg/l

Fresh water (intermittent releases): 0.01 mg/l

Marine water: 0.004 mg/l

STP: 1.6 mg/l

Freshwater sediment: 2.52 mg/kg of sediment dw

Marine water sediment: 0.252 mg/kg sediment dw

Soil: 0.852 mg/kg



LAVA DETAIL 20

Safety Data Sheet

According to Regulation (EC) No. 1907/2006 (REACH) with its Amendment Regulation (EC) No. 1272/2008 (CLP) and EU 2020/878

Printing Date 12. 11. 2025

Version Number 10 (replaces version 9)

Revision: 12. 11. 2025

8.2 Exposure controls

8.2.1. Appropriate engineering controls Provide adequate ventilation.

Individual protection measures, such as personal protective equipment

General Protective and Hygiene Measures:

Keep the product away from food, beverages, and animal feed.

Wash hands before taking breaks and after completing work.

Avoid eye and skin contact.

Refrain from eating, drinking, or smoking while using the product.

Remove contaminated clothing and wash thoroughly before reusing.

Do not inhale vapors or mists.

Respiratory Protection:



If ventilation is inadequate, use an appropriate respiratory protective device. In poorly ventilated areas or when spraying, an air-fed mask is recommended. For shorter periods, a combination of a charcoal filter and a particulate filter (A2-P2, EN529) is advised.

Hand Protection:



Wear chemical-resistant gloves that comply with standard EN 374-1. Gloves must be impermeable and resistant to the product or substances being handled. Consider glove material based on penetration times, diffusion rates, and degradation.

Material for Gloves:

For handling at room temperature:

- Butyl rubber (IIR) with a thickness of $\geq 0.5\text{mm}$ and a breakthrough time of ≥ 480 minutes.
- Fluorinated rubber (FKM) with a thickness of $\geq 0.4\text{mm}$ and a breakthrough time of ≥ 480 minutes.

Contaminated gloves should be disposed of properly. Glove selection depends not only on the material but also on other quality factors, which may vary by manufacturer. Since this product is a mixture, glove resistance should be verified before use. The recommended glove penetration time is ≥ 480 minutes, but in practice, gloves should be worn for a maximum of 50% of that time.

Eye/Face Protection:



Wear safety glasses with side shields (e.g., EN 166).

Body Protection:



Wear chemically resistant protective clothing (EN 14605) and protective boots.



LAVA DETAIL 20

Safety Data Sheet

According to Regulation (EC) No. 1907/2006 (REACH) with its Amendment Regulation (EC) No. 1272/2008 (CLP) and EU 2020/878

Printing Date 12. 11. 2025

Version Number 10 (replaces version 9)

Revision: 12. 11. 2025

SECTION 9: Physical and chemical properties

9.1 Information on basic physical and chemical properties

General Information

Physical state	Viscous liquid
Colour:	Various colours
Odour:	Characteristic
Odour threshold:	Not determined
Melting point/freezing point:	Not determined
Boiling point or initial boiling point and boiling range	130-150 °C (Reaction mass of ethylbenzene and m-xylene and p-xylene)
Flammability	Not applicable
Lower and upper explosion limit Lower: Upper:	Not determined Not determined
Flash point:	31 °C (Pensky-Martens)
Auto-ignition temperature:	488 °C (xylene, Reaction mass of ethylbenzene and m-xylene and p-xylene)
Decomposition temperature:	Not determined
Viscosity: Kinematic viscosity at 23 °C Dynamic at 20 °C:	54 s (ISO 2431/Flow time tISO) >90 mPas
Solubility water:	Not miscible



LAVA DETAIL 20

Safety Data Sheet

According to Regulation (EC) No. 1907/2006 (REACH) with its Amendment Regulation (EC) No. 1272/2008 (CLP) and EU 2020/878

Printing Date 12. 11. 2025

Version Number 10 (replaces version 9)

Revision: 12. 11. 2025

Partition coefficient n-octanol/water (log value)	Not determined
Vapour pressure:	Not determined
Density and/or relative density Density at 20 °C: Relative density Vapour density	1.35 g/cm ³ Not determined Not determined
9.2 Other information	
Appearance: Form:	Viscous liquid
Important information on protection of health and environment, and on safety	
Ignition temperature:	Product is not selfigniting.
Explosive properties:	Product is not explosive. However, formation of explosive air/vapour mixtures are possible.
Solvent separation test:	<1 % (UN Part III, par. 32.5.1)
Solvent content:	
VOC (EC)	249 g/l
Drip point:	
Oxidising properties	Not classified as an oxidizer according to CLP Regulation 1272/2008/EC.
Evaporation rate	Not determined



LAVA DETAIL 20

Safety Data Sheet

According to Regulation (EC) No. 1907/2006 (REACH) with its Amendment Regulation (EC) No. 1272/2008 (CLP) and EU 2020/878

Printing Date 12. 11. 2025

Version Number 10 (replaces version 9)

Revision: 12. 11. 2025

Information with regard to physical hazard classes

Explosives	Void
Flammable gases	Void
Aerosols	Void
Oxidising gases	Void
Gases under pressure	Void
Flammable liquids	Flammable liquid and vapour.
Flammable solids	Void
Self-reactive substances and mixtures	Void
Pyrophoric liquids	Void
Pyrophoric solids	Void
Self-heating substances and mixtures	Void
Substances and mixtures, which emit flammable gases in contact with water	Void
Oxidising liquids	Void
Oxidising solids	Void
Organic peroxides	Void
Corrosive to metals	Void
Desensitised explosives	Void



LAVA DETAIL 20

Safety Data Sheet

According to Regulation (EC) No. 1907/2006 (REACH) with its Amendment Regulation (EC) No. 1272/2008 (CLP) and EU 2020/878

Printing Date 12. 11. 2025

Version Number 10 (replaces version 9)

Revision: 12. 11. 2025

SECTION 10: Stability and reactivity

10.1 Reactivity

No additional relevant information available.

10.2 Chemical Stability

The product is stable under normal environmental temperatures.

Thermal decomposition/conditions to be avoided: none under recommended conditions.

10.3 Possibility of Hazardous Reactions

No known hazardous reactions.

10.4 Conditions to Avoid

Avoid exposure to heat, sparks, open flames, or any other ignition sources.

10.5 Incompatible Materials

Keep away from oxidizing agents.

10.6 Hazardous Decomposition Products

Potential decomposition products include carbon dioxide (CO₂) and carbon monoxide (CO).

SECTION 11: Toxicological information

11.1 Information on hazard classes as defined in Regulation (EC) No 1272/2008

Acute toxicity Based on available data, the classification criteria are not met.

LD/LC50 values relevant for classification: ATE (Acute Toxicity Estimates)

Inhalative	LC50/4 h (vapour)	107 mg/l
------------	-------------------	----------

Reaction mass of ethylbenzene and m-xylene and p-xylene

Oral	LD50	>3,523 mg/kg (rat)
Dermal	LD50	>12,126 mg/kg (rabbit)
Inhalative	LC50/4 h (vapour)	>27 mg/l (rat)

CAS: 13463-67-7 titanium dioxide

Dermal	LD50	>5,000 mg/kg (rat)
Inhalative	LC50/4 h (vapour)	>6.82 mg/l (rat)

CAS: 26471-62-5 m-tolylidene diisocyanate

Oral	LD50	>2,000 mg/kg (rat) (Acute Oral Toxicity)
Dermal	LD50	>2,000 mg/kg (rabbit) (Acute Dermal Toxicity)
Inhalative	LC50/4 h (vapour)	0.107 mg/l (rat)



LAVA DETAIL 20

Safety Data Sheet

According to Regulation (EC) No. 1907/2006 (REACH) with its Amendment Regulation (EC) No. 1272/2008 (CLP) and EU 2020/878

Printing Date 12. 11. 2025

Version Number 10 (replaces version 9)

Revision: 12. 11. 2025

CAS: 64359-81-5 4,5-dichloro-2-octyl-2H-isothiazol-3-one

Oral	LD50	567 mg/kg (ATE)
Inhalative	LC50/4h (dusts and mists)	0.16 mg/l

Skin Corrosion/Irritation Causes irritation to the skin.

Serious Eye Damage/Irritation Causes significant irritation to the eyes.

Respiratory or Skin Sensitisation

Inhalation may trigger allergic reactions, asthma symptoms, or breathing difficulties.

May cause an allergic reaction upon skin contact.

Germ Cell Mutagenicity

Based on current data, the product does not meet the criteria for classification.

Carcinogenicity Classification criteria are not met according to available data.

Reproductive Toxicity No evidence suggests this product meets the classification criteria.

STOT (Specific Target Organ Toxicity) – Single Exposure Available data indicates no classification is required.

STOT – Repeated Exposure

Classified as STOT Repeated Exposure Category 2.

Prolonged or repeated exposure may lead to organ damage.

Aspiration Hazard

Classified as Aspiration Toxicity Category 1.

May be fatal if swallowed and enters the respiratory system.

Additional Toxicological Information: The product may cause sensitization through skin contact.

11.2 Information on Other Hazards

Endocrine Disrupting Properties:

The product does not contain substances listed under Article 59(1) of REACH for endocrine-disrupting properties, nor does it meet the criteria of Commission Delegated Regulation (EU) 2017/2100 or Commission Regulation (EU) 2018/605 at concentrations of 0.1% or higher.

None of the ingredients are listed.

SECTION 12: Ecological information

12.1 Toxicity

Aquatic toxicity:

Reaction mass of ethylbenzene and m-xylene and p-xylene

EC50 (72h)	4.6-4.9 mg/l (algae)
EC50 (48h)	10.389 mg/l (Daphnia magna)
LC50 (96h)	>2.6 mg/l (fish)



LAVA DETAIL 20

Safety Data Sheet

According to Regulation (EC) No. 1907/2006 (REACH) with its Amendment Regulation (EC) No. 1272/2008 (CLP) and EU 2020/878

Printing Date 12. 11. 2025

Version Number 10 (replaces version 9)

Revision: 12. 11. 2025

CAS: 13463-67-7 titanium dioxide

EC50 (72h)	100 mg/l (algae)
EC50 (48h)	2.41-103.9 mg/l (Daphnia magna)
LC50 (96h)	1 mg/l (fish)
NOEC(72h)	100 mg/l (algae)
NOEC (21d)	5 mg/l (Daphnia magna)
NOEC (14d)	0.87-1.1 mg/l (fish)

CAS: 26471-62-5 m-tolyldiene diisocyanate

EC50 (72h)	3,230 mg/l (algae)
EC50 (48h)	12.5 mg/l (daphnia magna)
LC50 (96h)	133 mg/l (fish)

12.2 Persistence and Degradability

No additional information is available regarding persistence or degradability.

12.3 Bioaccumulative Potential

There is no further relevant information available concerning the bioaccumulative potential.

12.4 Mobility in Soil

No further details are available on the mobility of the product in soil.

12.5 PBT and vPvB Assessment Results

The product does not contain any components classified as persistent, bioaccumulative, and toxic (PBT), nor very persistent and very bioaccumulative (vPvB) at concentrations of 0.1% or higher, as outlined in REACH Annex XIII.

-PBT: Not applicable.

vPvB: Not applicable.

12.6 Endocrine Disrupting Properties

This product does not contain any substances listed under REACH Article 59(1) for endocrine disrupting properties. It has also not been identified as having endocrine-disrupting effects, according to the criteria in Commission Delegated Regulation (EU) 2017/2100 or Commission Regulation (EU) 2018/605, at concentrations of 0.1% or greater.



LAVA DETAIL 20

Safety Data Sheet

According to Regulation (EC) No. 1907/2006 (REACH) with its Amendment Regulation (EC) No. 1272/2008 (CLP) and EU 2020/878

Printing Date 12. 11. 2025

Version Number 10 (replaces version 9)

Revision: 12. 11. 2025

12.7 Other Adverse Effects

Remark: The product is harmful to fish.

Additional ecological information:

The product contains substances that pose a threat to the environment. It is harmful to aquatic life.

Avoid releasing undiluted product or large amounts into groundwater, watercourses, or sewage systems.

SECTION 13: Disposal considerations

13.1 Waste treatment methods

Recommendation

Dispose of this product in accordance with national regulations. It must not be discarded with household waste, and care should be taken to prevent the product from entering the sewage system.

For recycling information, please contact the manufacturer.



European Waste Catalogue Classifications:

- HP3: Flammable
- HP5: Specific Target Organ Toxicity (STOT) / Aspiration Toxicity
- HP14: Ecotoxic

Uncleaned Packaging:

Recommendation:

Dispose of packaging in compliance with official regulations.

SECTION 14: Transport information

14.1 UN number or ID number ADR, IMDG, IATA	UN1866
14.2 UN proper shipping name ADR IMDG, IATA	1866 RESIN SOLUTION RESIN SOLUTION
14.3 Transport hazard class(es) ADR, IMDG, IATA  Class Label	3 Flammable liquids. 3
14.4 Packing group ADR, IMDG, IATA	III



LAVA DETAIL 20

Safety Data Sheet

According to Regulation (EC) No. 1907/2006 (REACH) with its Amendment Regulation (EC) No. 1272/2008 (CLP) and EU 2020/878

Printing Date 12. 11. 2025

Version Number 10 (replaces version 9)

Revision: 12. 11. 2025

14.5 Environmental hazards: Marine pollutant:	No
14.6 Special precautions for user	Warning: Flammable liquids.
Hazard identification number (Kemler code):	30
EMS Number:	F-E, <u>S-E</u>
Stowage Category	A
14.7 Maritime transport in bulk according to IMO instruments	Not applicable.
Transport/Additional information:	
ADR Limited quantities (LQ) Excepted quantities (EQ)	5L Code: E1 Maximum net quantity per inner packaging: 30 ml Maximum net quantity per outer packaging: 1000 ml
Transport category	3
Tunnel restriction code	D/E
Remarks:	<ul style="list-style-type: none">• Viscous liquid par. 2.2.3.1.5., 2.2.3.1.5.2 ADR and par. 2.3.2.5 of the IMDG Code.• Exception for packages: ≤ 5 liters.- In accordance to paragraphs 2.2.3.1.5, 2.2.3.1.5.2 of ADR (road transport) and 2.3.2.5 of the IMDG Code (marine transport) for packaging ≤ 5 liters (L), are not subject to the ADR agreement and are not subject to the provisions for the marking, labelling and testing of packages (IMDG).



LAVA DETAIL 20

Safety Data Sheet

According to Regulation (EC) No. 1907/2006 (REACH) with its Amendment Regulation (EC) No. 1272/2008 (CLP) and EU 2020/878

Printing Date 12. 11. 2025

Version Number 10 (replaces version 9)

Revision: 12. 11. 2025

IMDG Limited quantities (LQ) Excepted quantities (EQ)	5L Code: E1 Maximum net quantity per inner packaging: 30 ml Maximum net quantity per outer packaging: 1000 ml
Remarks:	<ul style="list-style-type: none">• Viscous liquid par. 2.2.3.1.5., 2.2.3.1.5.2 ADR and par. 2.3.2.5 of the IMDG Code.• Exception for packages: ≤ 5 liters.- In accordance to paragraphs 2.2.3.1.5, 2.2.3.1.5.2 of ADR (road transport) and 2.3.2.5 of the IMDG Code (marine transport) for packaging ≤ 5 liters (L), are not subject to the ADR agreement and are not subject to the provisions for the marking, labelling and testing of packages (IMDG).
UN "Model Regulation":	UN 1866 RESIN SOLUTION, 3, III

SECTION 15: Regulatory information

15.1 Safety, Health, and Environmental Regulations/Legislation Specific to the Substance or Mixture

This product is subject to several regulations and directives, including Directive 94/62/EC on packaging and packaging waste, REACH Regulation 1907/2006/EC, Regulation (EU) 2020/878, and CLP Regulation 1272/2008/EC.

It also complies with Directive 98/24/EC, which focuses on the protection of workers from risks related to chemical agents at work, as well as Council Directive 94/33/EC concerning the protection of young people at work, as amended. Directive 92/85/EEC, addressing the health and safety of pregnant workers, workers who have recently given birth, or those who are breastfeeding, is also relevant, as amended.

Regarding **Directive 2012/18/EU**, the substance is not listed in Annex I as a named dangerous substance. It falls under Seveso category P5c for flammable liquids, with **qualifying quantities of 5,000 tonnes for lower-tier requirements and 50,000 tonnes for upper-tier requirements.**

Under Regulation (EC) No 1907/2006, Annex XVII, the conditions of restriction apply as per entries 3, 52a, and 74. **For Directive 2011/65/EU** on the restriction of hazardous substances in electrical and electronic equipment (Annex II), none of the ingredients are listed.

Similarly, under **Regulation (EU) 2019/1148**, none of the ingredients are listed as restricted or reportable explosive precursors in Annexes I and II, respectively.

In relation to drug precursors, none of the ingredients are listed under **Regulation (EC) No 273/2004** or **Regulation (EC) No 111/2005**, which oversees the trade of drug precursors between the Community and third countries.



LAVA DETAIL 20

Safety Data Sheet

According to Regulation (EC) No. 1907/2006 (REACH) with its Amendment Regulation (EC) No. 1272/2008 (CLP) and EU 2020/878

Printing Date 12. 11. 2025

Version Number 10 (replaces version 9)

Revision: 12. 11. 2025

For **national regulations**, no other relevant regulations, limitations, or prohibitions apply. This product does not contain substances of very high concern (SVHC) as defined by **REACH Article 57**.

15.2 Chemical Safety Assessment:

A Chemical Safety Assessment has not been performed for this substance.

SECTION 16: Other information

This information is based on our present knowledge. However, this shall not constitute a guarantee for any specific product features and shall not establish a legally valid contractual relationship.

Relevant phrases

H226 Flammable liquid and vapour.

H302 Harmful if swallowed.

H304 May be fatal if swallowed and enters airways.

H312 Harmful in contact with skin.

H314 Causes severe skin burns and eye damage.

H315 Causes skin irritation.

H317 May cause an allergic skin reaction.

H318 Causes serious eye damage.

H319 Causes serious eye irritation.

H330 Fatal if inhaled.

H332 Harmful if inhaled.

H334 May cause allergy or asthma symptoms or breathing difficulties if inhaled.

H335 May cause respiratory irritation.

H351 Suspected of causing cancer.

H373 May cause damage to organs through prolonged or repeated exposure.

H400 Very toxic to aquatic life.

H410 Very toxic to aquatic life with long lasting effects.

H412 Harmful to aquatic life with long lasting effects.

EUH204 Contains isocyanates. May produce an allergic reaction.

Classification according to Regulation (EC) No 1272/2008

Flammable liquids	Bridging principles
Skin corrosion/irritation. Serious eye damage/irritation. Respiratory sensitisation Skin sensitisation. Specific target organ toxicity (repeated exposure) Hazardous to the aquatic environment - long-term (chronic) aquatic hazard	The classification of the mixture is generally based on the calculation method using substance data according to Regulation (EC) No 1272/2008.
Aspiration hazard	Expert judgement



LAVA DETAIL 20

Safety Data Sheet

According to Regulation (EC) No. 1907/2006 (REACH) with its Amendment Regulation (EC) No. 1272/2008 (CLP) and EU 2020/878

Printing Date 12. 11. 2025

Version Number 10 (replaces version 9)

Revision: 12. 11. 2025



Department issuing SDS:

OWL WATERPROOFING SOLUTIONS

135 Slaney Road, Dublin Industrial Estate

Glasnevin, Dublin 11

Tel: +353 01 830 2250

Email: info@owlwaterproofing.co.uk

Website: www.owlwaterproofing.co.uk

Version number of previous version: 8

Abbreviations and acronyms:

ADR: Accord relatif au transport international des marchandises dangereuses par route (European Agreement Concerning the International Carriage of Dangerous Goods by Road)

IMDG: International Maritime Code for Dangerous Goods

IATA: International Air Transport Association

GHS: Globally Harmonised System of Classification and Labelling of Chemicals

EINECS: European Inventory of Existing Commercial Chemical Substances

ELINCS: European List of Notified Chemical Substances

CAS: Chemical Abstracts Service (division of the American Chemical Society)

VOC: Volatile Organic Compounds (USA, EU)

DNEL: Derived No-Effect Level (REACH)

PNEC: Predicted No-Effect Concentration (REACH)

LC50: Lethal concentration, 50 percent

LD50: Lethal dose, 50 percent

PBT: Persistent, Bioaccumulative and Toxic

SVHC: Substances of Very High Concern

vPvB: very Persistent and very Bioaccumulative

ATE: Acute toxicity estimate values

Flam. Liq. 3: Flammable liquids – Category 3

Acute Tox. 4: Acute toxicity – Category 4

Acute Tox. 2: Acute toxicity – Category 2

Skin Corr. 1: Skin corrosion/irritation – Category 1

Skin Irrit. 2: Skin corrosion/irritation – Category 2

Eye Dam. 1: Serious eye damage/eye irritation – Category 1

Eye Irrit. 2: Serious eye damage/eye irritation – Category 2

Resp. Sens. 1: Respiratory sensitisation – Category 1

Skin Sens. 1: Skin sensitisation – Category 1

Skin Sens. 1A: Skin sensitisation – Category 1A

Carc. 2: Carcinogenicity – Category 2

STOT SE 3: Specific target organ toxicity (single exposure) – Category 3

STOT RE 2: Specific target organ toxicity (repeated exposure) – Category 2

Asp. Tox. 1: Aspiration hazard – Category 1

Aquatic Acute 1: Hazardous to the aquatic environment - acute aquatic hazard – Category 1

Aquatic Chronic 1: Hazardous to the aquatic environment - long-term aquatic hazard – Category 1

Aquatic Chronic 3: Hazardous to the aquatic environment - long-term aquatic hazard – Category 3

*** Data compared to the previous version altered.**



LAVA 20 CLEAR TOP COAT

Safety Data Sheet

According to Regulation (EC) No. 1907/2006 (REACH) with its Amendment Regulation (EC) No. 1272/2008 (CLP) and EU 2020/878

Printing Date 18. 12. 2023

Version Number 4 (replaces version 3)

Revision: 18. 12. 2023

SECTION 1: Identification of the substance/mixture and of the company/undertaking

1.1 Product identifier

Trade name: LAVA 20 CLEAR TOP COAT

1.2 Relevant identified uses of the substance or mixture and uses advised against Professional use

Application of the substance / the mixture: Waterproofing Coating

1.3 Details of the supplier of the safety data sheet

Manufacturer/Supplier:

OWL WATERPROOFING SOLUTIONS

135 Slaney Road, Dublin Industrial Estate

Glasnevin, Dublin 11

Tel: +353 01 830 2250

Email: info@owlwaterproofing.co.uk

Website: www.owlwaterproofing.co.uk

1.4 Emergency telephone number:

European Emergency Tel.: +353 01 830 2250

SECTION 2: Hazards identification

2.1 Classification of the substance or mixture

Classification according to Regulation EC No 1272/2008 CLP:

GHS02 flame



Flam. Liq. 3 H226 Flammable liquid and vapour.

GHS08 health hazard



STOT RE 2 H373 May cause damage to organs through prolonged or repeated exposure.

Asp. Tox. 1 H304 May be fatal if swallowed and enters airways.

GHS07



Skin Irrit. 2 H315 Causes skin irritation.

Eye Irrit. 2 H319 Causes serious eye irritation.

Skin Sens. 1 H317 May cause an allergic skin reaction.

STOT SE 3 H335 May cause respiratory irritation.

Aquatic Chronic 3 H412 Harmful to aquatic life with long lasting effects.



LAVA 20 CLEAR TOP COAT

Safety Data Sheet

According to Regulation (EC) No. 1907/2006 (REACH) with its Amendment Regulation (EC) No. 1272/2008 (CLP) and EU 2020/878

Printing Date 18. 12. 2023

Version Number 4 (replaces version 3)

Revision: 18. 12. 2023

2.2 Label elements

Labelling according to Regulation EC No 1272/2008 CLP:

The product is classified and labelled according to the CLP regulation.

Hazard pictograms:



GHS02 GHS07 GHS08

Signal word: Danger

Hazard-determining components of labelling:

Reaction mass of ethylbenzene and m-xylene and p-xylene
1,6-hexanediyl-bis(2-(2-(1-ethylpentyl)-3-oxazolidinyl)ethyl)carbamate
3-Isocyanatomethyl-3,5,5-trimethylcyclohexyl isocyanate, oligomers
3-isocyanatomethyl-3,5,5-trimethylcyclohexyl isocyanate
maleic anhydride

Hazard statements:

H226 Flammable liquid and vapour.
H315 Causes skin irritation.
H319 Causes serious eye irritation.
H317 May cause an allergic skin reaction.
H335 May cause respiratory irritation.
H373 May cause damage to organs through prolonged or repeated exposure.
H304 May be fatal if swallowed and enters airways.
H412 Harmful to aquatic life with long lasting effects.

Precautionary statements

P210 Keep away from heat, hot surfaces, sparks, open flames and other ignition sources. No smoking.
P260 Do not breathe dust/fume/gas/mist/vapours/spray.
P280 Wear protective gloves/protective clothing/eye protection/face protection/hearing protection.
P302+P352 IF ON SKIN: Wash with plenty of water and soap.
P331 Do NOT induce vomiting.
P501 Dispose of contents/container in accordance with local/regional/national/international regulations.

Additional information:

EUH204 Contains isocyanates. May produce an allergic reaction.
As from 24 August 2023 adequate training is required before industrial or professional use.

2.3 Other Hazards

PBT and vPvB Assessment

This product does not contain any substances classified as persistent, bioaccumulative, and toxic (PBT) or very persistent and very bioaccumulative (vPvB) at or above a concentration of 0.1%.



LAVA 20 CLEAR TOP COAT

Safety Data Sheet

According to Regulation (EC) No. 1907/2006 (REACH) with its Amendment Regulation (EC) No. 1272/2008 (CLP) and EU 2020/878

Printing Date 18. 12. 2023

Version Number 4 (replaces version 3)

Revision: 18. 12. 2023

PBT: Not applicable.

vPvB: Not applicable.

Assessment of Endocrine-Disrupting Properties

No ingredients in this product are listed under Article 59(1) of REACH for endocrine-disrupting effects. Furthermore, it has not been identified as an endocrine disruptor under the criteria outlined in Commission Delegated Regulation (EU) 2017/2100 or Commission Regulation (EU) 2018/605 at concentrations of 0.1% or greater.

SECTION 3: Composition/ Information on Ingredients

3.2 Mixtures

Description: Mixture: consisting of the following components.

Ingredients according Regulation (EU) 2020/878:

EC number: 905-562-9 Reg.nr.: 01-2119488216-32-XXXX	Reaction mass of ethylbenzene and m-xylene and p-xylene Flam. Liq. 3, H226; STOT RE 2, H373; Asp. Tox. 1, H304; Acute Tox. 4, H312; Acute Tox. 4, H332; Skin Irrit. 2, H315; Eye Irrit. 2, H319; STOT SE 3, H335; Aquatic Chronic 3, H412 Specific concentration limit: STOT RE 2; H373: C ≥10 %	25-50%
CAS: 140921-24-0 ELINCS: 411-700-4 Index number: 616-079-00-5 Reg.nr.: 01-0000015906-63-XXXX	1,6-hexanediyl-bis(2-(2-(1-ethylpentyl)-3-oxazolidinyl)ethyl)carbamate Skin Sens. 1, H317	10-25%
CAS: 53880-05-0 EC number: 931-312-3 Reg.nr.: 01-2119488734-24-XXXX	3-Isocyanatomethyl-3,5,5-trimethylcyclohexyl isocyanate, oligomers Skin Sens. 1B, H317; STOT SE 3, H335	2.5-10%
CAS: 108-65-6 EINECS: 203-603-9 Index number: 607-195-00-7 Reg.nr.: 01-2119475791-29-XXXX	2-methoxy-1-methylethyl acetate Flam. Liq. 3, H226 substance with a Community workplace exposure limit	2.5-10%



LAVA 20 CLEAR TOP COAT

Safety Data Sheet

According to Regulation (EC) No. 1907/2006 (REACH) with its Amendment Regulation (EC) No. 1272/2008 (CLP) and EU 2020/878

Printing Date 18. 12. 2023

Version Number 4 (replaces version 3)

Revision: 18. 12. 2023

CAS: 4098-71-9 EINECS: 223-861-6 Index number: 615-008-00-5 Reg.nr.: 01-2119490408-31-XXXX	3-isocyanatomethyl-3,5,5-trimethylcyclohexyl isocyanate Acute Tox. 3, H331; Resp. Sens. 1, H334; Aquatic Chronic 2, H411; Skin Irrit. 2, H315; Eye Irrit. 2, H319; Skin Sens. 1, H317; STOT SE 3, H335, EUH204 Specific concentration limits: Resp. Sens. 1; H334: C \geq 0.5 % Skin Sens. 1; H317: C \geq 0.5 % substance with a Community workplace exposure limit	\geq 0.25- $<$ 0.5%
CAS: 540-84-1 EINECS: 208-759-1 Index number: 601-009-00-8 Reg.nr.: 01-2119457965-22-XXXX	2,2,4-trimethylpentane Flam. Liq. 2, H225; Asp. Tox. 1, H304; Aquatic Acute 1, H400; Aquatic Chronic 1, H410; Skin Irrit. 2, H315; STOT SE 3, H336	\geq 0.025- $<$ 0.25%
CAS: 108-31-6 EINECS: 203-571-6 Index number: 607-096-00-9 Reg.nr.: 01-2119472428-31-XXXX	maleic anhydride Resp. Sens. 1, H334; STOT RE 1, H372; Skin Corr. 1B, H314; Eye Dam. 1, H318; Acute Tox. 4, H302; Skin Sens. 1A, H317, EUH071 Specific concentration limit: Skin Sens. 1A; H317: C \geq 0.001 % substance with a Community workplace exposure limit	$<$ 0.001%

SVHC Statement

This product does not contain any substances of very high concern (SVHC) from the candidate list at concentrations equal to or exceeding 0.1%, as specified under Article 59 of Regulation (EC) No 1907/2006 (REACH).

SECTION 4: First Aid Measures

General Information:

Move the affected person to fresh air immediately.
Seek medical assistance without delay.



LAVA 20 CLEAR TOP COAT

Safety Data Sheet

According to Regulation (EC) No. 1907/2006 (REACH) with its Amendment Regulation (EC) No. 1272/2008 (CLP) and EU 2020/878

Printing Date 18. 12. 2023

Version Number 4 (replaces version 3)

Revision: 18. 12. 2023

Inhalation:

If the person is unconscious, place them in a stable side position for transport. Ensure they have access to fresh air and contact a doctor as a precaution.

Skin Contact:

Wash the affected area thoroughly with soap and water. Remove contaminated clothing and wash it before reuse. If irritation or discomfort persists, seek medical advice.

Eye Contact:

Rinse eyes immediately with plenty of water, lifting the upper and lower eyelids intermittently. If applicable, carefully remove contact lenses. Continue rinsing for at least 15 minutes. If irritation occurs, consult a medical professional. Avoid using a strong water jet to prevent corneal damage—medical consultation is advised.

Ingestion:

Do not induce vomiting. Seek medical attention immediately. Provide plenty of water to drink and ensure access to fresh air. Never administer anything orally to an unconscious individual.

4.2 Symptoms and Effects (Acute & Delayed)

No additional relevant information is available.

4.3 Immediate Medical Attention & Special Treatment

No specific recommendations beyond standard medical care.

SECTION 5: Firefighting Measures

5.1 Extinguishing Media

Suitable Extinguishing Methods:

Use carbon dioxide (CO₂), dry powder, or water spray to extinguish the fire. For larger fires, foam is recommended.

Unsuitable Extinguishing Methods:

Avoid using a full water jet, as it may not be effective for safety reasons.

5.2 Special Hazards Arising from the Substance or Mixture

In the event of fire or high temperatures, toxic gases may be released, including:

Carbon dioxide (CO₂)

Carbon monoxide (CO)

5.3 Firefighting Guidance

Firefighters should wear a fully protective suit.

Use a respiratory protective device to prevent inhalation of hazardous fumes.



LAVA 20 CLEAR TOP COAT

Safety Data Sheet

According to Regulation (EC) No. 1907/2006 (REACH) with its Amendment Regulation (EC) No. 1272/2008 (CLP) and EU 2020/878

Printing Date 18. 12. 2023

Version Number 4 (replaces version 3)

Revision: 18. 12. 2023

Additional Precautions:

Collect any contaminated firefighting water separately.

Ensure that it does not enter the sewage system or waterways.

SECTION 6: Accidental Release Measures

Precautionary Measures, Protective Gear, and Emergency Protocols

Avoid breathing in vapors.

Use an appropriate respiratory protection device.

Ensure protective gear is worn and keep unprotected individuals away.

Maintain a safe distance from potential ignition sources.

Non-Emergency Personnel:

Prevent contact with leaking or dripping substances.

Emergency Responders:

Utilize full protective equipment.

Restrict access to those without proper protection.

First-aid personnel must wear protective clothing, gloves, safety goggles, and a respiratory mask equipped with an A-type filter.

Environmental Safety Measures

Prevent soil and groundwater contamination.

Ensure the substance does not enter drains, surface water, or sewage systems.

Containment and Cleanup Methods

Absorb spills using sand, diatomaceous earth, or other suitable materials.

Dispose of collected waste in accordance with Section 13 regulations.

Additional References

For handling precautions, see Section 7.

For personal protection guidelines, refer to Section 8.

For waste disposal instructions, consult Section 13.

SECTION 7: Handling and Storage

Safe Handling Guidelines

Open containers carefully to prevent spills or splashes.

Handle with caution, avoiding shocks, friction, or sudden impacts.

Prevent skin and eye contact.

Maintain proper ventilation in the work area.

Do not eat, drink, or smoke while handling this product.

Thoroughly wash hands after use.

Clean and wash any contaminated clothing before wearing again.

Fire and Explosion Safety:

Keep away from ignition sources—smoking is prohibited.

Take precautions against electrostatic discharge.





LAVA 20 CLEAR TOP COAT

Safety Data Sheet

According to Regulation (EC) No. 1907/2006 (REACH) with its Amendment Regulation (EC) No. 1272/2008 (CLP) and EU 2020/878

Printing Date 18. 12. 2023

Version Number 4 (replaces version 3)

Revision: 18. 12. 2023

Storage Conditions and Compatibility

Store in airtight containers within a cool, well-ventilated environment.

Storage areas should be cool and temperature-controlled.

Keep away from oxidizing agents to prevent hazardous reactions.

Additional Storage Considerations:

Protect the product from heat and direct sunlight.

Always ensure containers are tightly sealed when not in use.

Specific End Uses

No additional relevant information is available.

SECTION 8: Exposure controls/ personal protection

Control Parameters

Ingredients with limit values that require monitoring at the workplace:

CAS: 108-65-6 2-methoxy-1-methylethyl acetate

IOELV (EU)	Short-term value: 550 mg/m ³ , 100 ppm Long-term value: 275 mg/m ³ , 50 ppm Skin
WEL (Great Britain)	Short-term value: 548 mg/m ³ , 100 ppm Long-term value: 274 mg/m ³ , 50 ppm Sk

CAS: 4098-71-9 3-isocyanatomethyl-3,5,5-trimethylcyclohexyl isocyanate

WEL (Great Britain)	Short-term value: 0.07 mg/m ³ Long-term value: 0.02 mg/m ³ Sen; as -NCO
---------------------	---

CAS: 108-31-6 maleic anhydride

WEL (Great Britain)	Short-term value: 3 mg/m ³ Long-term value: 1 mg/m ³ Sen
---------------------	--

DNELs

Substance: (EC: 905-562-9) Reaction mass of ethylbenzene, m-xylene, and p-xylene

Workers:

Long-term systemic exposure (inhalation): 221 mg/m³

Long-term local exposure (inhalation): 221 mg/m³

Short-term local exposure (inhalation): 442 mg/m³

Long-term systemic exposure (dermal): 212 mg/kg body weight/day



LAVA 20 CLEAR TOP COAT

Safety Data Sheet

According to Regulation (EC) No. 1907/2006 (REACH) with its Amendment Regulation (EC) No. 1272/2008 (CLP) and EU 2020/878

Printing Date 18. 12. 2023

Version Number 4 (replaces version 3)

Revision: 18. 12. 2023

Consumers:

Long-term systemic exposure (inhalation): 65.3 mg/m³
Short-term systemic exposure (inhalation): 260 mg/m³
Long-term local exposure (inhalation): 65.3 mg/m³
Short-term local exposure (inhalation): 260 mg/m³
Long-term systemic exposure (dermal): 125 mg/kg body weight/day
Long-term systemic exposure (oral): 12.5 mg/kg body weight/day

PNECs

Substance: (EC: 905-562-9) Reaction mass of ethylbenzene, m-xylene, and p-xylene
Freshwater: 0.044 mg/L
Intermittent freshwater releases: 0.01 mg/L
Marine water: 0.004 mg/L
Sewage treatment plant (STP): 1.6 mg/L
Freshwater sediment: 2.52 mg/kg (dry weight)
Marine water sediment: 0.252 mg/kg (dry weight)
Soil: 0.852 mg/kg

Exposure Controls

Engineering Controls

Ensure adequate ventilation in the work area.
Use local exhaust systems where vapors or mists are present.
Personal Protective Measures (PPE)

General Hygiene and Safety Precautions:

Keep the product away from food, drinks, and animal feed.
Wash hands before breaks and after handling.
Avoid direct contact with skin and eyes.
Remove and clean contaminated clothing before reuse.
Do not inhale vapors or mist.
Refrain from eating, drinking, or smoking while using the product.

Respiratory Protection:

Use suitable respiratory equipment if ventilation is insufficient.
In poorly ventilated areas or during spraying, wear a respirator.
Recommended options:



- Air-fed mask for prolonged exposure.
- Combination of A2-P2 charcoal and particulate filter (EN 529) for short-term work.

Hand Protection:

Wear chemical-resistant gloves that comply with EN 374-1 standards.
Gloves should be impermeable and resistant to the product's components.



Recommended materials:

- Butyl rubber (IIR): Thickness ≥ 0.5 mm, breakthrough time ≥ 480 min.
- Fluorinated rubber (FKM): Thickness ≥ 0.4 mm, breakthrough time ≥ 480 min.



LAVA 20 CLEAR TOP COAT

Safety Data Sheet

According to Regulation (EC) No. 1907/2006 (REACH) with its Amendment Regulation (EC) No. 1272/2008 (CLP) and EU 2020/878

Printing Date 18. 12. 2023

Version Number 4 (replaces version 3)

Revision: 18. 12. 2023

Contaminated gloves should be discarded after use. The effectiveness of gloves depends on manufacturer specifications and must be tested prior to use.

Penetration Time of Gloves:

As per EN 16523-1:2015, the recommended maximum wear time is 50% of the tested penetration time to ensure adequate protection.

Eye/Face Protection:

Use safety glasses with side shields or frame goggles (e.g., EN 166) to protect against splashes.



Body Protection:

Wear chemically resistant protective clothing that complies with EN 14605. Use protective boots designed for chemical exposure.



SECTION 9: Physical and Chemical Properties

9.1 Information on basic physical and chemical properties

General Information

Physical state	Viscous Liquid
Colour	Clear
Odour	Characteristic
Odour threshold	Not determined
Melting point/freezing point	Not determined
Boiling point or initial boiling point and boiling range	162 °C
Flammability	Not applicable
Lower and upper explosion limit Lower: Upper:	0.7 Vol % 7.5 Vol %
Flash point	30 °C



LAVA 20 CLEAR TOP COAT

Safety Data Sheet

According to Regulation (EC) No. 1907/2006 (REACH) with its
Amendment Regulation (EC) No. 1272/2008 (CLP) and EU 2020/878

Printing Date 18. 12. 2023

Version Number 4 (replaces version 3)

Revision: 18. 12. 2023

Auto-ignition temperature	315 °C
Decomposition temperature	Not determined
pH	Not determined
Viscosity: Kinematic viscosity	Not determined
Dynamic at 20 °C:	>40 mPas
Solubility water:	Not miscible
Partition coefficient n- octanol/water (log value)	Not determined
Vapour pressure at 20 °C:	5 hPa
Density and/or relative density Density at 20 °C:	1 g/cm ³
Relative density	Not determined
Vapour density	Not determined
Other Information	
Appearance: Form:	Viscous liquid
Important information on protection of health and environment, and on safety	
Ignition temperature:	Product is not selfigniting.



LAVA 20 CLEAR TOP COAT

Safety Data Sheet

According to Regulation (EC) No. 1907/2006 (REACH) with its
Amendment Regulation (EC) No. 1272/2008 (CLP) and EU 2020/878

Printing Date 18. 12. 2023

Version Number 4 (replaces version 3)

Revision: 18. 12. 2023

Explosive properties:	Product is not explosive. However, formation of explosive air/vapour mixtures are possible.
Solvent content: VOC (EC)	435gr/lt
Drip point: Oxidising properties	Not classified as an oxidizer according to CLP Regulation 1272/2008/EC.
Evaporation rate	Not determined
Information with regard to physical hazard classes	
Explosives	Void
Flammable gases	Void
Aerosols	Void
Oxidising gases	Void
Gases under pressure	Void
Flammable liquids	Flammable liquid and vapour.
Flammable solids	Void
Self-reactive substances and mixtures	Void
Pyrophoric liquids	Void
Pyrophoric solids	Void
Self-heating substances and mixtures	Void



LAVA 20 CLEAR TOP COAT

Safety Data Sheet

According to Regulation (EC) No. 1907/2006 (REACH) with its Amendment Regulation (EC) No. 1272/2008 (CLP) and EU 2020/878

Printing Date 18. 12. 2023

Version Number 4 (replaces version 3)

Revision: 18. 12. 2023

Substances and mixtures, which emit flammable gases in contact with water	Void
Oxidising liquids	Void
Oxidising solids	Void
Organic peroxides	Void
Corrosive to metals	Void
Desensitised explosives	Void

SECTION 10: Stability and reactivity

Reactivity

The product remains stable under normal conditions of use and storage.

Chemical Stability

Stable under standard environmental and handling conditions.

Thermal decomposition

Avoid excessive heat to prevent breakdown.

Remains stable at ambient temperatures.

Possibility of Hazardous Reactions

No known hazardous reactions under normal use.

Conditions to Avoid

Keep away from: Heat sources, Sparks, Open flames, Other ignition sources

Materials to Avoid

Avoid contact with oxidizing agents, as this may cause a reaction.

Hazardous Decomposition Products

Under high heat or combustion, the following toxic gases may be released:

Carbon dioxide (CO₂)

Carbon monoxide (CO)

SECTION 11: Toxicological Information

Hazard Classification as per Regulation (EC) No 1272/2008

Acute Toxicity: Available data indicates no classification required under the specified criteria.

LD/LC50 values relevant for classification:

Reaction mass of ethylbenzene and m-xylene and p-xylene



LAVA 20 CLEAR TOP COAT

Safety Data Sheet

According to Regulation (EC) No. 1907/2006 (REACH) with its Amendment Regulation (EC) No. 1272/2008 (CLP) and EU 2020/878

Printing Date 18. 12. 2023

Version Number 4 (replaces version 3)

Revision: 18. 12. 2023

Oral	LD50	>3,523 mg/kg (rat)
Dermal	LD50	>12,126 mg/kg (rabbit)
Inhalative	LC50/4 h (vapour)	>27 mg/l (rat)

CAS: 140921-24-0 1,6-hexanediyl-bis(2-(2-(1-ethylpentyl)-3-oxazolidinyl)ethyl)carbamate

Oral	LD50	>2,000 mg/kg (rat)
------	------	--------------------

CAS: 53880-05-0 3-Isocyanatomethyl-3,5,5-trimethylcyclohexyl isocyanate, oligomers

Oral	LD50	14,000 mg/kg (rat)
------	------	--------------------

CAS: 108-65-6 2-methoxy-1-methylethyl acetate

Oral	LD50	>5,000 mg/kg (rat)
Dermal	LD50	>5,000 mg/kg (rat)
Inhalative	LC50/4 h (vapour)	1,805.05 ppm (rat)

CAS: 4098-71-9 3-isocyanatomethyl-3,5,5-trimethylcyclohexyl isocyanate

Oral	LD50	4,814 mg/kg (rat)
Dermal	LD50	7,000 mg/kg (rat)
Inhalative	LC50/4 h (vapour)	>31 mg/l (rat)

11.1 Classification of Hazards (Regulation (EC) No 1272/2008)

Skin Corrosion/Irritation Causes skin irritation.

Serious Eye Damage/Irritation Causes severe eye irritation.

Respiratory or Skin Sensitization May trigger an allergic skin reaction.

Germ Cell Mutagenicity No evidence of mutagenic effects based on available data.

Carcinogenicity Not classified as a carcinogen according to current data.

Reproductive Toxicity No classification required, as data does not indicate reproductive toxicity.



LAVA 20 CLEAR TOP COAT

Safety Data Sheet

According to Regulation (EC) No. 1907/2006 (REACH) with its Amendment Regulation (EC) No. 1272/2008 (CLP) and EU 2020/878

Printing Date 18. 12. 2023

Version Number 4 (replaces version 3)

Revision: 18. 12. 2023

STOT (Specific Target Organ Toxicity) – Single Exposure

Classified under Category 3.

May cause respiratory irritation.

STOT – Repeated Exposure

Falls under Category 2.

Prolonged or repeated exposure may cause organ damage.

Aspiration Hazard

Classified as Category 1 for aspiration toxicity.

May be fatal if ingested and enters the airways.

Additional Hazard Information

Endocrine Disrupting Properties

This product does not contain substances listed under Article 59(1) of REACH for endocrine-disrupting effects.

It has also not been identified as an endocrine disruptor under Commission Delegated Regulation (EU) 2017/2100 or Commission Regulation (EU) 2018/605 at concentrations of 0.1% or higher.

SECTION 12: Ecological Information

Toxicity

Aquatic toxicity

Reaction mass of ethylbenzene and m-xylene and p-xylene

EC50 (72h)	4.6-4.9 mg/l (algae)
EC50 (48h)	10.389 mg/l (Daphnia magna)
LC50 (96h)	>2.6 mg/l (fish)

CAS: 53880-05-0 3-Isocyanatomethyl-3,5,5-trimethylcyclohexyl isocyanate, oligomers

EC50 (72h)	3.1 mg/l (algae)
EC50 (48h)	3.36 mg/l (Daphnia magna)

CAS: 108-65-6 2-methoxy-1-methylethyl acetate

EC50 (48h)	8.8 mg/l (crustaceans)
LC50 (96h)	6.83 mg/l (fish)



LAVA 20 CLEAR TOP COAT

Safety Data Sheet

According to Regulation (EC) No. 1907/2006 (REACH) with its Amendment Regulation (EC) No. 1272/2008 (CLP) and EU 2020/878

Printing Date 18. 12. 2023

Version Number 4 (replaces version 3)

Revision: 18. 12. 2023

CAS: 4098-71-9 3-isocyanatomethyl-3,5,5-trimethylcyclohexyl isocyanate

EC50 (72h)	4.8 mg/l (Daphnia magna) 70 mg/l (algae)
LC50 (96h)	208 mg/l (fish)

Persistence and Degradability No additional relevant data available.

Bioaccumulation Potential No significant information available.

Soil Mobility No relevant data available.

12.5 PBT and vPvB Assessment

This product does not contain substances classified as Persistent, Bioaccumulative, and Toxic (PBT) or Very Persistent and Very Bioaccumulative (vPvB) at concentrations $\geq 0.1\%$ as per REACH Annex XIII.

PBT: Not applicable.

vPvB: Not applicable.

Endocrine Disrupting Properties

The product does not contain substances identified under Article 59(1) of REACH for endocrine-disrupting effects.

It has also not been classified as an endocrine disruptor under Commission Delegated Regulation (EU) 2017/2100 or Commission Regulation (EU) 2018/605 at concentrations $\geq 0.1\%$.

Other Environmental Effects

Toxicity to aquatic life: Harmful to fish.

Additional Ecological Notes:

Contains components that may pose a risk to the environment.

Potentially hazardous to aquatic organisms.

SECTION 13: Disposal Considerations

Waste Treatment Methods

Disposal Recommendations:

Dispose of waste in accordance with national regulations.

Do not discard with household waste.

Prevent the product from entering sewage systems or water sources.

Handling of Contaminated Packaging:

Recommendation: Dispose of packaging in compliance with official regulations.



European Waste Catalogue

HP3

Flammable

HP4

Irritant - skin irritation and eye damage



LAVA 20 CLEAR TOP COAT

Safety Data Sheet

According to Regulation (EC) No. 1907/2006 (REACH) with its Amendment Regulation (EC) No. 1272/2008 (CLP) and EU 2020/878

Printing Date 18. 12. 2023

Version Number 4 (replaces version 3)

Revision: 18. 12. 2023

HP5	Specific Target Organ Toxicity (STOT)/Aspiration Toxicity
HP6	Acute Toxicity
HP13	Sensitising
HP14	Ecotoxic

SECTION 14: Transport Information

14.1 UN number or ID number ADR, IMDG, IATA	UN1866
14.2 UN proper shipping name ADR IMDG, IATA	1866 RESIN SOLUTION RESIN SOLUTION
14.3 Transport hazard class(es) ADR, IMDG, IATA  Class Label	3 Flammable liquids. 3
14.4 Packing group ADR, IMDG, IATA	III
14.5 Environmental hazards: Marine pollutant	No
14.6 Special precautions for user	Warning: Flammable liquids.



LAVA 20 CLEAR TOP COAT

Safety Data Sheet

According to Regulation (EC) No. 1907/2006 (REACH) with its Amendment Regulation (EC) No. 1272/2008 (CLP) and EU 2020/878

Printing Date 18. 12. 2023

Version Number 4 (replaces version 3)

Revision: 18. 12. 2023

Hazard identification number (Kemler code):	30
EMS Number:	F-E, <u>S-E</u>
Stowage Category 14.7 Maritime transport in bulk according to IMO instruments	A Not applicable.
Transport/Additional information:	
ADR Limited quantities (LQ) Excepted quantities (EQ)	5L Code: E1 Maximum net quantity per inner packaging: 30 ml Maximum net quantity per outer packaging: 1000 ml
Transport category	3
Tunnel restriction code	D/E
IMDG Limited quantities (LQ) Excepted quantities (EQ)	5L Code: E1 Maximum net quantity per inner packaging: 30 ml Maximum net quantity per outer packaging: 1000 ml
UN "Model Regulation":	UN 1866 RESIN SOLUTION, 3, III

SECTION 15: Regulatory Information

15.1 Safety, Health, and Environmental Legislation Applicable to the Substance or Mixture

This product is subject to the following European regulations and directives:

Directive 94/62/EC – Concerning packaging and packaging waste, REACH Regulation (EC) No. 1907/2006, Regulation (EU) 2020/878, CLP Regulation (EC) No. 1272/2008



LAVA 20 CLEAR TOP COAT

Safety Data Sheet

According to Regulation (EC) No. 1907/2006 (REACH) with its Amendment Regulation (EC) No. 1272/2008 (CLP) and EU 2020/878

Printing Date 18. 12. 2023

Version Number 4 (replaces version 3)

Revision: 18. 12. 2023

Directive 98/24/EC – Protection of workers from chemical agents, Council Directive 94/33/EC – Protection of young workers (as amended), Directive 92/85/EEC – Safety at work for pregnant and breastfeeding workers (as amended), Directive 2012/18/EU (Seveso III Directive) – Not listed under Annex I

Seveso Classification:

Category: P5c – Flammable Liquids

Thresholds:

Lower-tier requirement: 5,000 tonnes

Upper-tier requirement: 50,000 tonnes

REACH Annex XVII Restrictions: Subject to the following restriction entries: 3 and 74

Directive 2011/65/EU (RoHS Directive): No ingredients fall under Annex II restrictions for hazardous substances in electrical and electronic equipment.

Regulation (EU) 2019/1148 – Explosives Precursors:

Annex I (Restricted): No components listed

Annex II (Reportable): No components listed

Drug Precursor Legislation:

Regulation (EC) No. 273/2004: No relevant ingredients

Regulation (EC) No. 111/2005: No relevant ingredients

National Legislation: No additional national regulations are reported.

Other Restrictions and Limitations:

Substances of Very High Concern (SVHC): This mixture does not contain SVHC substances in accordance with REACH Article 57.

15.2 Chemical Safety Assessment: A chemical safety assessment has not been conducted for this substance or mixture.

SECTION 16: Other Information

This information is based on our present knowledge. However, this shall not constitute a guarantee for any specific product features and shall not establish a legally valid contractual relationship.

Relevant phrases

H225 Highly flammable liquid and vapour.

H226 Flammable liquid and vapour.

H302 Harmful if swallowed.

H304 May be fatal if swallowed and enters airways.

H312 Harmful in contact with skin.

H314 Causes severe skin burns and eye damage.

H315 Causes skin irritation.

H317 May cause an allergic skin reaction.

H318 Causes serious eye damage.

H319 Causes serious eye irritation.

H331 Toxic if inhaled.

H332 Harmful if inhaled.



LAVA 20 CLEAR TOP COAT

Safety Data Sheet

According to Regulation (EC) No. 1907/2006 (REACH) with its Amendment Regulation (EC) No. 1272/2008 (CLP) and EU 2020/878

Printing Date 18. 12. 2023

Version Number 4 (replaces version 3)

Revision: 18. 12. 2023

H334 May cause allergy or asthma symptoms or breathing difficulties if inhaled.
H335 May cause respiratory irritation.
H336 May cause drowsiness or dizziness.
H372 Causes damage to organs through prolonged or repeated exposure.
H373 May cause damage to organs through prolonged or repeated exposure.
H400 Very toxic to aquatic life.
H410 Very toxic to aquatic life with long lasting effects.
H411 Toxic to aquatic life with long lasting effects.
H412 Harmful to aquatic life with long lasting effects.
EUH071 Corrosive to the respiratory tract.
EUH204 Contains isocyanates. May produce an allergic reaction.

Training and Classification Information

Training Guidance

Employees should receive adequate training on the safe handling, storage, and processing of the product. Training should be tailored to reflect all relevant safety information currently available.

Classification Overview (According to Regulation (EC) No 1272/2008)

This product is classified under the following hazard categories:

Flammable Liquids – Based on bridging principles

Classification of the mixture is primarily determined through the calculation method using available substance data, as specified in Regulation (EC) No 1272/2008.

Skin Corrosion/Irritation

Serious Eye Damage/Irritation

Skin Sensitisation

Specific Target Organ Toxicity – Single Exposure (STOT-SE)

Specific Target Organ Toxicity – Repeated Exposure (STOT-RE)

Chronic Aquatic Hazard – Hazardous to the aquatic environment (long-term effects)

Aspiration Hazard – Assessed using expert judgement

Department issuing SDS:



OWL WATERPROOFING SOLUTIONS

135 Slaney Road, Dublin Industrial Estate

Glasnevin, Dublin 11

Tel: +353 01 830 2250

Email: info@owlwaterproofing.co.uk

Website: www.owlwaterproofing.co.uk



LAVA 20 CLEAR TOP COAT

Safety Data Sheet

According to Regulation (EC) No. 1907/2006 (REACH) with its
Amendment Regulation (EC) No. 1272/2008 (CLP) and EU 2020/878

Printing Date 18. 12. 2023

Version Number 4 (replaces version 3)

Revision: 18. 12. 2023

Version number of previous version: 3

Abbreviations and acronyms:

ADR: Accord relatif au transport international des marchandises dangereuses par route (European Agreement Concerning the

International Carriage of Dangerous Goods by Road)

IMDG: International Maritime Code for Dangerous Goods

IATA: International Air Transport Association

GHS: Globally Harmonised System of Classification and Labelling of Chemicals

EINECS: European Inventory of Existing Commercial Chemical Substances

ELINCS: European List of Notified Chemical Substances

CAS: Chemical Abstracts Service (division of the American Chemical Society)

DNEL: Derived No-Effect Level (REACH)

PNEC: Predicted No-Effect Concentration (REACH)

LC50: Lethal concentration, 50 percent

LD50: Lethal dose, 50 percent

PBT: Persistent, Bioaccumulative and Toxic

SVHC: Substances of Very High Concern

vPvB: very Persistent and very Bioaccumulative

Flam. Liq. 2: Flammable liquids – Category 2

Flam. Liq. 3: Flammable liquids – Category 3

Acute Tox. 4: Acute toxicity – Category 4

Acute Tox. 3: Acute toxicity – Category 3

Skin Corr. 1B: Skin corrosion/irritation – Category 1B

Skin Irrit. 2: Skin corrosion/irritation – Category 2

Eye Dam. 1: Serious eye damage/eye irritation – Category 1

Eye Irrit. 2: Serious eye damage/eye irritation – Category 2

Resp. Sens. 1: Respiratory sensitisation – Category 1

Skin Sens. 1: Skin sensitisation – Category 1

Skin Sens. 1A: Skin sensitisation – Category 1A

Skin Sens. 1B: Skin sensitisation – Category 1B

STOT SE 3: Specific target organ toxicity (single exposure) – Category 3

STOT RE 1: Specific target organ toxicity (repeated exposure) – Category 1

STOT RE 2: Specific target organ toxicity (repeated exposure) – Category 2

Asp. Tox. 1: Aspiration hazard – Category 1

Aquatic Acute 1: Hazardous to the aquatic environment - acute aquatic hazard – Category 1

Aquatic Chronic 1: Hazardous to the aquatic environment - long-term aquatic hazard – Category 1

Aquatic Chronic 2: Hazardous to the aquatic environment - long-term aquatic hazard – Category 2

Aquatic Chronic 3: Hazardous to the aquatic environment - long-term aquatic hazard – Category 3

*** Data compared to the previous version altered.**



LAVA 20 COLOURED TOP COAT

Safety Data Sheet

According to Regulation (EC) No. 1907/2006 (REACH) with its Amendment Regulation (EC) No. 1272/2008 (CLP) and EU 2020/878

Printing Date 23. 11. 2023

Version Number 6 (replaces version 5)

Revision: 23. 11. 2023

SECTION 1: Identification of the substance/mixture and of the company/undertaking

1.1 Product identifier

Trade name: LAVA 20 COLOURED TOP COAT

1.2 Relevant identified uses of the substance or mixture and uses advised against Professional use

Application of the substance / the mixture: Polyurethane Waterproofing Coating

1.3 Details of the supplier of the safety data sheet

Manufacturer/Supplier:

OWL WATERPROOFING SOLUTIONS

135 Slaney Road, Dublin Industrial Estate

Glasnevin, Dublin 11

Tel: +353 01 830 2250

Email: info@owlwaterproofing.co.uk

Website: www.owlwaterproofing.co.uk

1.4 Emergency telephone number:

European Emergency Tel.: +353 01 830 2250

SECTION 2: Hazards identification

2.1 Classification of the substance or mixture

Classification according to Regulation EC No 1272/2008 CLP:

GHS02 flame



Flam. Liq. 3 H226 Flammable liquid and vapour.

GHS08 health hazard



STOT RE 2 H373 May cause damage to organs through prolonged or repeated exposure.

Asp. Tox. 1 H304 May be fatal if swallowed and enters airways.

GHS07



Skin Irrit. 2 H315 Causes skin irritation.

Eye Irrit. 2 H319 Causes serious eye irritation.

Skin Sens. 1 H317 May cause an allergic skin reaction.

STOT SE 3 H335 May cause respiratory irritation.

Aquatic Chronic 3 H412 Harmful to aquatic life with long lasting effects.



LAVA 20 COLOURED TOP COAT

Safety Data Sheet

According to Regulation (EC) No. 1907/2006 (REACH) with its Amendment Regulation (EC) No. 1272/2008 (CLP) and EU 2020/878

Printing Date 15. 07. 2021

Version Number 5 (replaces version 4)

Revision: 15. 07. 2021

2.2 Label elements

Labelling according to Regulation EC No 1272/2008 CLP:

The product is classified and labelled according to the CLP regulation.

Hazard pictograms:



GHS02 GHS07 GHS08

Signal word: Danger

Hazard-determining components of labelling:

Reaction mass of ethylbenzene and m-xylene and p-xylene

1,6-hexanediyl-bis(2-(2-(1-ethylpentyl)-3-oxazolidinyl)ethyl)carbamate

3-Isocyanatomethyl-3,5,5-trimethylcyclohexyl isocyanate, oligomers

4,5-dichloro-2-octyl-2H-isothiazol-3-one

maleic anhydride

3-isocyanatomethyl-3,5,5-trimethylcyclohexyl isocyanate

Addition reaction products of conjugated sunflower-oil fatty acids and tall-oil fatty acids with maleic anhydride

Hazard statements:

H226 Flammable liquid and vapour.

H315 Causes skin irritation.

H319 Causes serious eye irritation.

H317 May cause an allergic skin reaction.

H335 May cause respiratory irritation.

H373 May cause damage to organs through prolonged or repeated exposure.

H304 May be fatal if swallowed and enters airways.

H412 Harmful to aquatic life with long lasting effects.

Precautionary statements

P210 Keep away from heat, hot surfaces, sparks, open flames and other ignition sources. No smoking.

P260 Do not breathe dust/fume/gas/mist/vapours/spray.

P280 Wear protective gloves/protective clothing/eye protection/face protection/hearing protection.

P302+P352 IF ON SKIN: Wash with plenty of water and soap.

P331 Do NOT induce vomiting.

P501 Dispose of contents/container in accordance with local/regional/national/international regulations.

Additional information:

EUH204 Contains isocyanates. May produce an allergic reaction.

EUH211 Warning! Hazardous respirable droplets may be formed when sprayed. Do not breathe spray or mist.

As from 24 August 2023 adequate training is required before industrial or professional use.



LAVA 20 COLOURED TOP COAT

Safety Data Sheet

According to Regulation (EC) No. 1907/2006 (REACH) with its Amendment Regulation (EC) No. 1272/2008 (CLP) and EU 2020/878

Printing Date 23. 11. 2023

Version Number 6 (replaces version 5)

Revision: 23. 11. 2023

2.3 Other hazards

Results of PBT and vPvB assessment

The product does not contain ingredients that are considered either persistent, bioaccumulative and toxic (PBT) or very persistent and very bioaccumulative (vPvB) at a level of 0.1% or higher.

PBT: Not applicable.

vPvB: Not applicable.

Determination of endocrine-disrupting properties

The product does not contain substances included in the list established in accordance with Article 59(1) of REACH for endocrine disrupting properties or has not been identified as having endocrine disrupting properties according to the criteria set out in Commission Delegated Regulation (EU) 2017/2100 or Commission Regulation (EU) 2018/605 at a concentration equal to or higher than 0.1%.

SECTION 3: Composition/information on ingredients

3.2 Mixtures

Description: Mixture: consisting of the following components.

Ingredients according Regulation (EU) 2020/878:

EC number: 905-562-9 Reg.nr.: 01-2119488216-32-XXXX	Reaction mass of ethylbenzene and m-xylene and pxylene Flam. Liq. 3, H226; STOT RE 2, H373; Asp. Tox. 1, H304; Acute Tox. 4, H312; Acute Tox. 4, H332; Skin Irrit. 2, H315; Eye Irrit. 2, H319; STOT SE 3, H335; Aquatic Chronic 3, H412 Specific concentration limit: STOT RE 2; H373: C ≥10 %	≥30- <40%
CAS: 140921-24-0 ELINCS: 411-700-4 Index number: 616-079-00-5 Reg.nr.: 01-0000015906-63-XXXX	1,6-hexanediyl-bis(2-(2-(1-ethylpentyl)-3-oxazolidinyl)ethyl)carbamate Skin Sens. 1, H317	≥3-<5%
CAS: 108-65-6 EINECS: 203-603-9 Index number: 607-195-00-7 Reg.nr.: 01-2119475791-29-XXXX	2-methoxy-1-methylethyl acetate Flam. Liq. 3, H226 substance with a Community workplace exposure limit	≥3-<5%



LAVA 20 COLOURED TOP COAT

Safety Data Sheet

According to Regulation (EC) No. 1907/2006 (REACH) with its Amendment Regulation (EC) No. 1272/2008 (CLP) and EU 2020/878

Printing Date 23. 11. 2023

Version Number 6 (replaces version 5)

Revision: 23. 11. 2023

CAS: 53880-05-0 EC number: 931-312-3 Reg.nr.: 01-2119488734-24-XXXX	3-Isocyanatomethyl-3,5,5-trimethylcyclohexyl isocyanate, oligomers Skin Sens. 1B, H317; STOT SE 3, H335	≥3-<5%
CAS: 4098-71-9 EINECS: 223-861-6 Index number: 615-008-00-5 Reg.nr.: 01-2119490408-31-XXXX	3-isocyanatomethyl-3,5,5-trimethylcyclohexyl isocyanate Acute Tox. 3, H331; Resp. Sens. 1, H334; Aquatic Chronic 2, H411; Skin Irrit. 2, H315; Eye Irrit. 2, H319; Skin Sens. 1, H317; STOT SE 3, H335, EUH204 Specific concentration limits: Resp. Sens. 1; H334: C ≥ 0.5 % Skin Sens. 1; H317: C ≥ 0.5 % substance with a Community workplace exposure limit	≥0.25-<0.5%
EC number: 701-043-4 Reg.nr.: 01-2119976378-19-XXXX	Addition reaction products of conjugated sunflower oil fatty acids and tall-oil fatty acids with maleic anhydride Skin Irrit. 2, H315; Skin Sens. 1, H317	≥0.25-<0.5%
CAS: 108-31-6 EINECS: 203-571-6 Index number: 607-096-00-9 Reg.nr.: 01-2119472428-31-XXXX	maleic anhydride Resp. Sens. 1, H334; STOT RE 1, H372; Skin Corr. 1B, H314; Eye Dam. 1, H318; Acute Tox. 4, H302; Skin Sens. 1A, H317, EUH071 Specific concentration limit: Skin Sens. 1A; H317: C ≥ 0.001 % substance with a Community workplace exposure limit	≥0.001-<0.1%



LAVA 20 COLOURED TOP COAT

Safety Data Sheet

According to Regulation (EC) No. 1907/2006 (REACH) with its Amendment Regulation (EC) No. 1272/2008 (CLP) and EU 2020/878

Printing Date 23. 11. 2023

Version Number 6 (replaces version 5)

Revision: 23. 11. 2023

CAS: 64359-81-5 EINECS: 264-843-8 Index number: 613-335-00-8	4,5-dichloro-2-octyl-2H-isothiazol-3-one Acute Tox. 2, H330; Skin Corr. 1, H314; Eye Dam. 1, H318; Aquatic Acute 1, H400 (M=100); Aquatic Chronic 1, H410 (M=100); Acute Tox. 4, H302; Skin Sens. 1A, H317 ATE: LD50 oral: 567 mg/kg Specific concentration limits: Skin Irrit. 2; H315: C ≥0.025 % Eye Irrit. 2; H319: C ≥ 0.025 % Skin Sens. 1A; H317: C ≥ 0.0015 %	≥0.0025- <0.025%
CAS: 13463-67-7 EINECS: 236-675-5 Index number: 022-006-00-2 Reg.nr.: 01-2119489379-17-XXXX	titanium dioxide substance with a Community workplace exposure limit	≥10-<25%

SVHC

This product does not contain candidate substances of very high concern at a concentration ≥0.1% (Regulation (EC) No 1907/2006 (REACH), Article 59)

Additional information:

(CAS:13463-67-7) Titanium dioxide

Note 10: The classification as a carcinogen by inhalation applies only to mixtures in powder form containing 1% or more of titanium dioxide which is in the form of or incorporated in particles with aerodynamic diameter ≤10 µm.

For the wording of the listed hazard phrases refer to section 16.

SECTION 4: First aid measures

4.1 Description of first aid measures

General information:

Medical observation is required for at least 48 hours after the accident since symptoms of poisoning may not show up for several hours.

Allow affected people to get some fresh air. Request medical help immediately

After inhalation:

If the patient becomes unconscious, secure him in a side position for transportation.

Get fresh air.

If symptoms last, see a doctor.



LAVA 20 COLOURED TOP COAT

Safety Data Sheet

According to Regulation (EC) No. 1907/2006 (REACH) with its Amendment Regulation (EC) No. 1272/2008 (CLP) and EU 2020/878

Printing Date 23. 11. 2023

Version Number 6 (replaces version 5)

Revision: 23. 11. 2023

After skin contact:

Wash with soap and water immediately, then thoroughly rinse.

Talk to a doctor if skin irritation persists.

Take off any contaminated clothing.

After eye contact:

Rinse the opened eye under flowing water for at least 15 minutes.

Safeguard uninjured eye.

Seek immediate medical assistance.

After swallowing:

Do not force yourself to vomit; instead, contact emergency help right away.

Ensure you are getting lots of fresh air and drink. Make a doctor's appointment immediately.

Seek emergency medical attention.

Never offer anything by mouth to an unconscious individual.

4.2 Most important symptoms and effects, both acute and delayed

No further relevant information available.

4.3 Indication of any immediate medical attention and special treatment needed

No further relevant information available.

SECTION 5: Firefighting measures

5.1 Extinguishing media

Suitable extinguishing agents: CO₂, powder or water spray.

For safety reasons unsuitable extinguishing agents: Water with full jet

5.2 Special hazards arising from the substance or mixture No further relevant information available.

5.3 Advice for firefighters

Protective equipment:

Self-contained breathing gear and full protective clothes are required.

Additional information

Separately collect contaminated fire-fighting water. It should not go down the sewage line.

SECTION 6: Accidental release measures

6.1 Personal precautions, protective equipment and emergency procedures:

Wear safety gear when necessary. Keep vulnerable people at a distance.

Avoid breathing in fumes.

Stay away from sources of ignition.

Keep away from skin and eye contact

Do not inhale vapors or spray.

6.1.1 Non-emergency personnel: Steer clear of any material that is dripping or leaking.

6.1.2 Emergency responders: Responders must wear appropriate protective gear, including gloves, goggles, protective clothing, and a respirator fitted with an A-type filter.

6.2 Environmental precautions: Do not allow to enter sewers/ surface or ground water.

6.3 Methods and material for containment and cleaning up:



LAVA 20 COLOURED TOP COAT

Safety Data Sheet

According to Regulation (EC) No. 1907/2006 (REACH) with its Amendment Regulation (EC) No. 1272/2008 (CLP) and EU 2020/878

Printing Date 23. 11. 2023

Version Number 6 (replaces version 5)

Revision: 23. 11. 2023

Utilize absorbent material to collect (sand, diatomite).

6.4 Reference to other sections:

See Section 7 for information on safe handling.

See Section 8 for information on personal protection equipment.

See Section 13 for disposal information.

SECTION 7: Handling and storage

7.1 Precautions for safe handling

Ensure good ventilation/exhaustion at the workplace.

Keep away from skin and eyes.

Refrain from eating, drinking, or smoking while using this product.

Wash any contaminated clothing before wearing it again.

Be sure to wash your hands thoroughly after handling the product.

Information about fire - and explosion protection:

Avoid smoking and keep all combustible materials away.

Safeguard against electrostatic charges.



7.2 Conditions for safe storage, including any incompatibilities

Storage: Keep in tightly sealed containers, stored in a cool, dry, and well-ventilated area.

Requirements to be met by storerooms and receptacles: Store far from combustible materials

Information about storage in one common storage facility: Store far from oxidizing agents.

Further information about storage conditions:

Preserve the container tightly locked.

Protect from heat and direct sunlight.

7.3 Specific end use(s) No further relevant information available.

SECTION 8: Exposure controls/personal protection

8.1 Control parameters

Ingredients with limit values that require monitoring at the workplace:

CAS: 13463-67-7 titanium dioxide

WEL (Great Britain)	Long-term value: 10* 4** mg/m ³ *total inhalable **respirable
---------------------	---

CAS: 108-65-6 2-methoxy-1-methylethyl acetate

IOELV (EU)	Short-term value: 550 mg/m ³ , 100 ppm Long-term value: 275 mg/m ³ , 50 ppm Skin
WEL (Great Britain)	Short-term value: 548 mg/m ³ , 100 ppm Long-term value: 274 mg/m ³ , 50 ppm Sk



LAVA 20 COLOURED TOP COAT

Safety Data Sheet

According to Regulation (EC) No. 1907/2006 (REACH) with its Amendment Regulation (EC) No. 1272/2008 (CLP) and EU 2020/878

Printing Date 23. 11. 2023

Version Number 6 (replaces version 5)

Revision: 23. 11. 2023

CAS: 4098-71-9 3-isocyanatomethyl-3,5,5-trimethylcyclohexyl isocyanate

WEL (Great Britain)	Short-term value: 0.07 mg/m ³ Long-term value: 0.02 mg/m ³ Sen; as -NCO
---------------------	---

CAS: 108-31-6 maleic anhydride

WEL (Great Britain)	Short-term value: 3 mg/m ³ Long-term value: 1 mg/m ³ Sen
---------------------	--

DNELs

(EC: 905-562-9) Reaction mass of ethylbenzene, m-xylene and p-xylene

Workers:

Long-term systemic effect, by inhalation: 221 mg/m³

Long-term local effect, by inhalation: 221 mg/m³

Short-term local effect, inhalation: 442 mg/m³

Long-term systemic effect, dermal: 212 mg/kg bw/d

Consumers:

Long-term systemic effect, inhalation: 65.3 mg/m³

Short-term systemic effect, inhalation: 260 mg/m³

Long-term local effect, inhalation: 65.3 mg/m³

Short-term local effect, inhalation: 260 mg/m³

Long-term systemic effect, dermal: 125 mg/kg bw/d

Long-term systemic effect, oral: 12.5 mg/kg bw/d

(CAS: 108-65-6) 2-methoxy-1-methylethyl acetate

Employees:

Inhalation - Long-term systemic effect: 275 mg/m³

Inhalation - Short-term acute effect: 550 mg/m³

Skin - Long-term systemic effect: 796 mg/kg bw/d

Consumers:

Inhalation - Long-term systemic effect: 33 mg/m³

Inhalation - Long-term local effect: 33 mg/m³

Skin - Long-term systemic effect: 320 mg/kg bw/d

Oral - Long-term systemic effect: 36 mg/kg bw/d

Oral - Short-term acute effect: 500 mg/kg bw/d

(CAS: 13463-67-7) Titanium dioxide

Employees:

Inhalation - Local effects, Long-term exposure: 1.25 mg/m³



LAVA 20 COLOURED TOP COAT

Safety Data Sheet

According to Regulation (EC) No. 1907/2006 (REACH) with its Amendment Regulation (EC) No. 1272/2008 (CLP) and EU 2020/878

Printing Date 23. 11. 2023

Version Number 6 (replaces version 5)

Revision: 23. 11. 2023

Consumers:

Inhalation - Local effects, Long-term exposure: 210 µg/m³

PNECs

(EC: 905-562-9) reaction mass of ethylbenzene and m-xylene and p-xylene

Fresh water: 0,044 mg/l

Marine water: 0,004 mg/l

Fresh water sediment: 2,52 mg/kg

Marine water sediment: 0,252 mg/kg

Soil: 0,852 mg/kg

STP - Waste water treatment plant: 1,6 mg/l

(CAS: 108-65-6) 2-methoxy-1-methylethyl acetate

Freshwater: 0.635 mg/l

Marine water: 0.0635 mg/l

Intermittent releases: 6.35 mg/l

Sediment (freshwater): 3.29 mg/kg

Sediment (marine water): 0.329 mg/kg

Soil: 0.29 mg/kg

STP: 100 mg/l

8.2 Exposure controls

8.2.1. Appropriate engineering controls No other recommendations, see chapter 7.

Individual protection measures, such as personal protective equipment

General protective and hygienic measures:

Store away from food, drinks, and animal feed.

Clean hands before taking breaks and after completing work.

Prevent contact with skin and eyes.

Refrain from eating, drinking, or smoking while handling this product.

Ensure sufficient ventilation during use.

Take off contaminated clothing and wash it before reuse.

Respiratory protection:



In cases of inadequate ventilation, use an appropriate respiratory protection gear. Respiratory protection is necessary while spraying and in poorly ventilated work spaces. For brief durations of labor, a charcoal filter and particle filter A2-P2 (EN529) combination mask or an air-fed mask are advised.



LAVA 20 COLOURED TOP COAT

Safety Data Sheet

According to Regulation (EC) No. 1907/2006 (REACH) with its Amendment Regulation (EC) No. 1272/2008 (CLP) and EU 2020/878

Printing Date 23. 11. 2023

Version Number 6 (replaces version 5)

Revision: 23. 11. 2023

Hand protection:



Protective gloves resistant to chemicals (standard EN 374-1)

Selection of the glove material on consideration of the penetration times, rates of diffusion and the degradation. Due to missing tests no recommendation to the glove material can be given for the product/ the preparation/ the chemical mixture. The glove material has to be impermeable and resistant to the product/ the substance/ the preparation.

Material of gloves

Hand protection when handling the product at room temperature:

Butyl rubber - IIR: thickness $\geq 0.5\text{mm}$; breakthrough time $\geq 480\text{min}$.

Fluorinated rubber - FKM: thickness $\geq 0.4\text{mm}$; breakthrough time $\geq 480\text{min}$.

Recommendation: contaminated gloves should be disposed of.

The material used for the gloves must be waterproof and resistant to the product, substance, or preparation.

No advice for the glove material for the product, preparation, or chemical mixture can be made due to a lack of studies. Choose the glove material while taking the degradation, diffusion, and penetration rates into account.

Penetration time of glove material

The penetration times specified according to EN 16523-1:2015 are not based on real-world conditions. It is recommended to limit the maximum wearing time to 50% of the tested penetration time.

Eye/face protection



Safety glasses with side-shields (frame goggles) (e.g. EN 166)

Body protection:



Chemically resistant, protective work clothing (EN 14605) and boots.

SECTION 9: Physical & chemical properties

9.1 Information on basic physical and chemical properties

General Information

Physical state	Liquid
Colour	Various colours



LAVA 20 COLOURED TOP COAT

Safety Data Sheet

According to Regulation (EC) No. 1907/2006 (REACH) with its Amendment Regulation (EC) No. 1272/2008 (CLP) and EU 2020/878

Printing Date 23. 11. 2023

Version Number 6 (replaces version 5)

Revision: 23. 11. 2023

Odour	Characteristic
Odour threshold:	Not determined
Melting point/freezing point:	Not determined
Flammability	Not applicable
Lower and upper explosion limit Lower: Upper:	Not determined Not determined
Flash point:	27 °C (Reaction mass of ethylbenzene and m-xylene and p-xylene)
Auto-ignition temperature:	488 °C
Decomposition temperature:	Not determined
pH	Not determined
Viscosity: Kinematic viscosity Dynamic at 20 °C:	Not determined >40 mPas
Solubility water:	Not miscible
Partition coefficient n-octanol/water (log value)	Not determined
Vapour pressure:	Not determined
Density and/or relative density Density at 20 °C:	1.14 g/cm ³



LAVA 20 COLOURED TOP COAT

Safety Data Sheet

According to Regulation (EC) No. 1907/2006 (REACH) with its Amendment Regulation (EC) No. 1272/2008 (CLP) and EU 2020/878

Printing Date 23. 11. 2023

Version Number 6 (replaces version 5)

Revision: 23. 11. 2023

Relative density	Not determined
Vapour density	Not determined
9.2 Other information Appearance:	
Form:	Liquid
Important information on protection of health and environment, and on safety. Ignition temperature:	Product is not selfigniting.
Explosive properties:	Product is not explosive. However, formation of explosive air/vapour mixtures are possible.
Solvent content: VOC (EC)	460 g/l
Cloud point / clarification point: Oxidising properties	Not classified as an oxidizer according to CLP Regulation 1272/2008/EC.
Evaporation rate	Not determined
Information with regard to physical hazard classes	
Explosives	Void
Flammable gases	Void
Aerosols	Void
Oxidising gases	Void



LAVA 20 COLOURED TOP COAT

Safety Data Sheet

According to Regulation (EC) No. 1907/2006 (REACH) with its Amendment Regulation (EC) No. 1272/2008 (CLP) and EU 2020/878

Printing Date 23. 11. 2023

Version Number 6 (replaces version 5)

Revision: 23. 11. 2023

Gases under pressure	Void
Flammable liquids	Flammable liquid and vapour.
Flammable solids	Void
Self-reactive substances and mixtures	Void
Pyrophoric liquids	Void
Pyrophoric solids	Void
Self-heating substances and mixtures	Void
Substances and mixtures, which emit flammable gases in contact with water	Void
Oxidising liquids	Void
Oxidising solids	Void
Organic peroxides	Void
Corrosive to metals	Void
Desensitised explosives	Void

SECTION 10: Stability and reactivity

10.1 Reactivity No further relevant information available.

10.2 Chemical stability

Thermal decomposition / conditions to be avoided Stable at environment temperature.

10.3 Possibility of hazardous reactions No dangerous reactions known.



LAVA 20 COLOURED TOP COAT

Safety Data Sheet

According to Regulation (EC) No. 1907/2006 (REACH) with its Amendment Regulation (EC) No. 1272/2008 (CLP) and EU 2020/878

Printing Date 23. 11. 2023

Version Number 6 (replaces version 5)

Revision: 23. 11. 2023

10.4 Conditions to avoid Avoid heat, sparkles, naked flame or other sources of ignition.

10.5 Incompatible materials No further relevant information available.

10.6 Hazardous decomposition products No dangerous decomposition products known.

SECTION 11: Toxicological information

11.1 Information on hazard classes as defined in Regulation (EC) No 1272/2008

Acute toxicity Based on available data, the classification criteria are not met.

LD/LC50 values relevant for classification:

Reaction mass of ethylbenzene and m-xylene and p-xylene

Oral	LD50	>3,523 mg/kg (rat)
Dermal	LD50	>12,126 mg/kg (rabbit)
Inhalative	LC50/4 h (vapour)	>27 mg/l (rat)

CAS: 140921-24-0 1,6-hexanediyl-bis(2-(2-(1-ethylpentyl)-3-oxazolidinyl)ethyl)carbamate

Oral	LD50	>2,000 mg/kg (rat)
------	------	--------------------

CAS: 108-65-6 2-methoxy-1-methylethyl acetate

Oral	LD50	>5,000 mg/kg (rat)
Dermal	LD50	>5,000 mg/kg (rat)
Inhalative	LC50 (4h)	1,805.05 ppm (rat)

CAS: 53880-05-0 3-Isocyanatomethyl-3,5,5-trimethylcyclohexyl isocyanate, oligomers

Oral	LD50	14,000 mg/kg (rat)
------	------	--------------------

CAS: 4098-71-9 3-isocyanatomethyl-3,5,5-trimethylcyclohexyl isocyanate

Oral	LD50	4,814 mg/kg (rat)
Dermal	LD50	7,000 mg/kg (rat)
Inhalative	LC50/ 4h (vapour)	>31 mg/l (rat)



LAVA 20 COLOURED TOP COAT

Safety Data Sheet

According to Regulation (EC) No. 1907/2006 (REACH) with its Amendment Regulation (EC) No. 1272/2008 (CLP) and EU 2020/878

Printing Date 23. 11. 2023

Version Number 6 (replaces version 5)

Revision: 23. 11. 2023

Addition reaction products of conjugated sunflower-oil fatty acids and tall-oil fatty acids with maleic anhydride

Oral	LD50	>2,000 mg/kg (rat)
-------------	-------------	------------------------------

CAS: 64359-81-5 4,5-dichloro-2-octyl-2H-isothiazol-3-one

Oral	LD50	567 mg/kg (ATE)
Inhalative	LC50/ 4h (dusts & mists)	0.16 mg/l

CAS: 108-31-6 maleic anhydride

Oral	LD50	400 mg/kg (rat)
Dermal	LD50	2,620 mg/kg (rabbit)

Skin corrosion/irritation Causes skin irritation.

Serious eye damage/irritation Causes serious eye irritation.

Respiratory or skin sensitisation May cause an allergic skin reaction.

Germ cell mutagenicity Based on available data, the classification criteria are not met.

Carcinogenicity Based on available data, the classification criteria are not met.

Reproductive toxicity Based on available data, the classification criteria are not met.

STOT-single exposure

The product is classified as Specific Target Organ Toxicity after single exposure Category 3

May cause respiratory irritation.

STOT-repeated exposure

STOT Repeated Exposure Category 2

May cause damage to organs through prolonged or repeated exposure.

11.2 Information on other hazards

Endocrine disrupting properties

This product does not contain substances listed under Article 59(1) of REACH for endocrine-disrupting properties, nor has it been identified as having endocrine-disrupting properties according to the criteria in Commission Delegated Regulation (EU) 2017/2100 or Commission Regulation (EU) 2018/605, at concentrations equal to or greater than 0.1%.

None of the ingredients is listed.



LAVA 20 COLOURED TOP COAT

Safety Data Sheet

According to Regulation (EC) No. 1907/2006 (REACH) with its Amendment Regulation (EC) No. 1272/2008 (CLP) and EU 2020/878

Printing Date 23. 11. 2023

Version Number 6 (replaces version 5)

Revision: 23. 11. 2023

SECTION 12: Ecological information

12.1 Toxicity

Aquatic toxicity:

Reaction mass of ethylbenzene and m-xylene and p-xylene

EC50 (72h)	4.6-4.9 mg/l (algae)
EC50 (48h)	10.389 mg/l (Daphnia magna)
LC50 (96h)	>2.6 mg/l (fish)

CAS: 108-65-6 2-methoxy-1-methylethyl acetate

EC50 (48h)	8.8 mg/l (crustaceans)
LC50 (96h)	6.83 mg/l (fish)

CAS: 53880-05-0 3-Isocyanatomethyl-3,5,5-trimethylcyclohexyl isocyanate, oligomers

EC50 (72h)	3.1 mg/l (algae)
EC50 (48h)	3.36 mg/l (Daphnia magna)

CAS: 4098-71-9 3-isocyanatomethyl-3,5,5-trimethylcyclohexyl isocyanate

EC50 (72h)	4.8 mg/l (Daphnia magna) 70 mg/l (algae)
LC50 (96h)	208 mg/l (fish)

Addition reaction products of conjugated sunflower-oil fatty acids and tall-oil fatty acids with maleic anhydride

EC50 (72h)	100 mg/l (algae)
EC50 (48h)	100 mg/l (Daphnia magna)
LC50 (96h)	150 mg/l (fish)



LAVA 20 COLOURED TOP COAT

Safety Data Sheet

According to Regulation (EC) No. 1907/2006 (REACH) with its Amendment Regulation (EC) No. 1272/2008 (CLP) and EU 2020/878

Printing Date 23. 11. 2023

Version Number 6 (replaces version 5)

Revision: 23. 11. 2023

NOEC(72h)	100 mg/l (algae)
NOEC (21d)	10 mg/l (Daphnia magna)

12.2 Persistence and degradability No further relevant information available.

12.3 Bioaccumulative potential No further relevant information available.

12.4 Mobility in soil No further relevant information available.

12.5 Results of PBT and vPvB assessment

The product does not contain ingredients that are considered to be persistent, bioaccumulative and toxic (PBT) or very persistent and very bioaccumulative at levels of 0.1% or higher according to REACH, Annex XIII.

PBT: Not applicable.

vPvB: Not applicable.

12.6 Endocrine disrupting properties For information on endocrine disrupting properties see section 11.

This product does not contain substances listed under Article 59(1) of REACH for endocrine-disrupting effects, nor has it been recognized as having such properties based on the criteria outlined in Commission Delegated Regulation (EU) 2017/2100 or Commission Regulation (EU) 2018/605, at concentrations of 0.1% or higher.

12.7 Other adverse effects

Remark: Harmful to fish

Additional ecological information:

General notes:

Do not allow undiluted product or large quantities of it to reach ground water, water course or sewage system.

The product contains materials that are harmful to the environment.

Harmful to aquatic organisms

SECTION 13: Disposal considerations

13.1 Waste treatment methods

Recommendation

Dispose according to National Regulations.



Not to be disposed of with regular trash. Do not let product enter the drainage system.

European waste catalogue	
HP3	Flammable
HP4	Irritant - skin irritation and eye damage



LAVA 20 COLOURED TOP COAT

Safety Data Sheet

According to Regulation (EC) No. 1907/2006 (REACH) with its Amendment Regulation (EC) No. 1272/2008 (CLP) and EU 2020/878

Printing Date 23. 11. 2023

Version Number 6 (replaces version 5)

Revision: 23. 11. 2023

HP5	Specific Target Organ Toxicity (STOT)/Aspiration Toxicity
HP6	Acute Toxicity
HP14	Ecotoxic

Uncleaned Packaging:

Recommendation:

Dispose of packaging in accordance with official regulations. After proper cleaning, packaging can be reused or recycled.

SECTION 14: Transport information

14.1 UN number or ID number ADR, IMDG, IATA	UN1866
14.2 UN proper shipping name ADR IMDG, IATA	1866 RESIN SOLUTION RESIN SOLUTION
14.3 Transport hazard class(es) ADR, IMDG, IATA  Class Label	 3 Flammable liquids 3
14.4 Packing group ADR, IMDG, IATA	III
14.5 Environmental hazards: Marine pollutant:	No
14.6 Special precautions for user	Warning: Flammable liquids.



LAVA 20 COLOURED TOP COAT



Safety Data Sheet

According to Regulation (EC) No. 1907/2006 (REACH) with its Amendment Regulation (EC) No. 1272/2008 (CLP) and EU 2020/878

Printing Date 23. 11. 2023

Version Number 6 (replaces version 5)

Revision: 23. 11. 2023

Hazard identification number (Kemler code):	30
EMS Number:	F-E,S-E
14.7 Maritime transport in bulk according to IMO instruments	Not applicable.
Transport/Additional information:	
ADR Limited quantities (LQ) Limited Quantity Marking 	5L
Excepted quantities (EQ)	Code: E1 Maximum net quantity per inner packaging: 30 ml Maximum net quantity per outer packaging: 1000 ml
Transport category	3
Tunnel restriction code	D/E
IMDG Limited quantities (LQ) Limited Quantity Marking. 	5L



LAVA 20 COLOURED TOP COAT

Safety Data Sheet

According to Regulation (EC) No. 1907/2006 (REACH) with its Amendment Regulation (EC) No. 1272/2008 (CLP) and EU 2020/878

Printing Date 23. 11. 2023

Version Number 6 (replaces version 5)

Revision: 23. 11. 2023

Excepted quantities (EQ)	Code: E1 Maximum net quantity per inner packaging: 30 ml Maximum net quantity per outer packaging: 1000 ml
UN "Model Regulation":	UN 1866 RESIN SOLUTION, 3, III

SECTION 15: Regulatory information

15.1 Safety, health and environmental regulations/legislation specific for the substance or mixture

REACH Regulation (1907/2006/EC), Regulation (EU) 2020/878, CLP Regulation (1272/2008/EC), Directive 98/24/EC on the protection of workers' health and safety from risks associated with chemical agents in the workplace, Directive 94/62/EC on packaging and packaging waste, Council Directive 94/33/EC on the protection of young workers as amended, and Directive 92/85/EEC on improving safety and health at work for pregnant workers, recent mothers, or those breastfeeding, as amended.

Directive 2012/18/EU

Named dangerous substances - ANNEX I Substance is not listed.

Seveso category P5c FLAMMABLE LIQUIDS

Qualifying quantity (tonnes) for the application of lower-tier requirements 5,000 t

Qualifying quantity (tonnes) for the application of upper-tier requirements 50,000 t

REGULATION (EC) No 1907/2006 ANNEX XVII Conditions of restriction: 3, 74

DIRECTIVE 2011/65/EU on the restriction of the use of certain hazardous substances in electrical and electronic equipment – Annex II

None of the ingredients is listed.

REGULATION (EU) 2019/1148

Annex I - RESTRICTED EXPLOSIVES PRECURSORS (Upper limit value for the purpose of licensing under Article 5(3))

None of the ingredients is listed.

Annex II - REPORTABLE EXPLOSIVES PRECURSORS

None of the ingredients is listed.

Regulation (EC) No 273/2004 on drug precursors

None of the ingredients is listed.

Regulation (EC) No 111/2005 laying down rules for the monitoring of trade between the Community and third countries in drug precursors

None of the ingredients is listed.

National regulations: None

Other regulations, limitations and prohibitive regulations

Substances of very high concern (SVHC) according to REACH, Article 57

It doesn't contain substances of very high concern (SVHC).

15.2 Chemical safety assessment: A Chemical Safety Assessment has not been carried out.



LAVA 20 COLOURED TOP COAT

Safety Data Sheet

According to Regulation (EC) No. 1907/2006 (REACH) with its Amendment Regulation (EC) No. 1272/2008 (CLP) and EU 2020/878

Printing Date 23. 11. 2023

Version Number 6 (replaces version 5)

Revision: 23. 11. 2023

SECTION 16: Other information

This information is based on our present knowledge. However, this shall not constitute a guarantee for any specific product features and shall not establish a legally valid contractual relationship.

Relevant phrases

H226 Flammable liquid and vapour.

H302 Harmful if swallowed.

H304 May be fatal if swallowed and enters airways.

H312 Harmful in contact with skin.

H314 Causes severe skin burns and eye damage.

H315 Causes skin irritation.

H317 May cause an allergic skin reaction.

H318 Causes serious eye damage.

H319 Causes serious eye irritation.

H330 Fatal if inhaled.

H331 Toxic if inhaled.

H332 Harmful if inhaled.

H334 May cause allergy or asthma symptoms or breathing difficulties if inhaled.

H335 May cause respiratory irritation.

H372 Causes damage to organs through prolonged or repeated exposure.

H373 May cause damage to organs through prolonged or repeated exposure.

H400 Very toxic to aquatic life.

H410 Very toxic to aquatic life with long lasting effects.

H411 Toxic to aquatic life with long lasting effects.

H412 Harmful to aquatic life with long lasting effects.

EUH071 Corrosive to the respiratory tract.

EUH204 Contains isocyanates. May produce an allergic reaction.

Training Recommendations:

Employees should receive appropriate training on the safe handling, storage, and processing of the product, utilizing all available information.

Classification according to Regulation (EC) No 1272/2008

Flammable liquids	Bridging principles
Skin corrosion/irritation. Serious eye damage/irritation. Skin sensitisation Specific target organ toxicity (single exposure) Specific target organ toxicity (repeated exposure) Hazardous to the aquatic environment - long-term (chronic) aquatic hazard	The classification of the mixture is generally based on the calculation method using substance data according to Regulation (EC) No 1272/2008.



LAVA 20 COLOURED TOP COAT

Safety Data Sheet

According to Regulation (EC) No. 1907/2006 (REACH) with its Amendment Regulation (EC) No. 1272/2008 (CLP) and EU 2020/878

Printing Date 23. 11. 2023

Version Number 6 (replaces version 5)

Revision: 23. 11. 2023

Aspiration hazard

Expert judgement



Department issuing SDS:

OWL WATERPROOFING SOLUTIONS

135 Slaney Road, Dublin Industrial Estate

Glasnevin, Dublin 11

Tel: +353 01 830 2250

Email: info@owlwaterproofing.co.uk

Website: www.owlwaterproofing.co.uk

Version number of previous version: 5

Abbreviations and acronyms:

ADR: Accord relatif au transport international des marchandises dangereuses par route (European Agreement Concerning the International Carriage of Dangerous Goods by Road)

IMDG: International Maritime Code for Dangerous Goods

IATA: International Air Transport Association

GHS: Globally Harmonised System of Classification and Labelling of Chemicals

EINECS: European Inventory of Existing Commercial Chemical Substances

ELINCS: European List of Notified Chemical Substances

CAS: Chemical Abstracts Service (division of the American Chemical Society)

VOC: Volatile Organic Compounds (USA, EU)

DNEL: Derived No-Effect Level (REACH)

PNEC: Predicted No-Effect Concentration (REACH)

LC50: Lethal concentration, 50 percent

LD50: Lethal dose, 50 percent

PBT: Persistent, Bioaccumulative and Toxic

SVHC: Substances of Very High Concern

vPvB: very Persistent and very Bioaccumulative

Flam. Liq. 3: Flammable liquids – Category 3

Acute Tox. 4: Acute toxicity – Category 4

Acute Tox. 2: Acute toxicity – Category 2

Acute Tox. 3: Acute toxicity – Category 3

Skin Corr. 1: Skin corrosion/irritation – Category 1

Skin Corr. 1B: Skin corrosion/irritation – Category 1B

Skin Irrit. 2: Skin corrosion/irritation – Category 2

Eye Dam. 1: Serious eye damage/eye irritation – Category 1

Eye Irrit. 2: Serious eye damage/eye irritation – Category 2

Resp. Sens. 1: Respiratory sensitisation – Category 1

Skin Sens. 1: Skin sensitisation – Category 1

Skin Sens. 1A: Skin sensitisation – Category 1A

Skin Sens. 1B: Skin sensitisation – Category 1B

STOT SE 3: Specific target organ toxicity (single exposure) – Category 3

STOT RE 1: Specific target organ toxicity (repeated exposure) – Category 1

STOT RE 2: Specific target organ toxicity (repeated exposure) – Category 2

Asp. Tox. 1: Aspiration hazard – Category 1

Aquatic Acute 1: Hazardous to the aquatic environment - acute aquatic hazard – Category 1

Aquatic Chronic 1: Hazardous to the aquatic environment - long-term aquatic hazard – Category 1

Aquatic Chronic 2: Hazardous to the aquatic environment - long-term aquatic hazard – Category 2

Aquatic Chronic 3: Hazardous to the aquatic environment - long-term aquatic hazard – Category 3

*** Data compared to the previous version altered.**



XYLENE

Safety Data Sheet

According to Regulation (EC) No. 1907/2006 (REACH) with its Amendment Regulation (EC) No. 1272/2008 (CLP) and EU 2020/878

Printing Date 18. 09. 2025

Version Number 01

Revision: 18. 09. 2025

SECTION 1: Identification of the substance/mixture and of the company/undertaking

1.1 Product identifier

Trade name: Xylene

1.2 Relevant identified uses of the substance or mixture and uses advised against Professional Use

Application of the substance / the mixture: Binders and release agents, Polymer production and processing, Oil and gas drilling and production operations, Manufacturing and distribution of substances, Intermediates and formulation/repacking of substances and mixtures, Cleaning and washing agents, additives, and coatings, Lubricants, fuel additives, and laboratory chemicals

1.3 Details of the supplier of the safety data sheet

Manufacturer/Supplier:

OWL WATERPROOFING SOLUTIONS

135 Slaney Road, Dublin Industrial Estate

Glasnevin, Dublin 11

Tel: +353 01 830 2250

Email: info@owlwaterproofing.co.uk

Website: www.owlwaterproofing.co.uk

1.4 Emergency telephone number:

European Emergency Tel.: +353 01 830 2250

SECTION 2: Hazards identification

2.1 Substance or Mixture Classification

Classification as per Regulation (EC) No 1272/2008 (CLP):

GHS02



Flammable liquids. 3 (H226)

GHS07



Skin Irrit. 2 (H315): Causes skin irritation.

Eye Irrit. 2 (H319): Causes serious eye irritation.

GHS08



Aspiration hazard. 1 (H304):

2.2 Label Elements

Labelling in Accordance with Regulation (EC) No 1272/2008 (CLP): Classified and labelled according to the CLP regulation.

Hazard Pictograms: GHS02 GHS07 GHS08





XYLENE

Safety Data Sheet

According to Regulation (EC) No. 1907/2006 (REACH) with its Amendment Regulation (EC) No. 1272/2008 (CLP) and EU 2020/878

Printing Date 18. 09. 2025

Version Number 01

Revision: 18. 09. 2025

Signal Word: Warning

Hazard Statements:

H226: Flammable liquid and vapour.

H304: May be fatal if swallowed and enters airways.

H312+H332: Harmful in contact with skin or if inhaled.

H315: Causes skin irritation.

H319: Causes serious eye irritation.

H335: May cause respiratory irritation.

H373: May cause damage to organs through prolonged or repeated exposure.

Precautionary Measures:

P101: If medical advice is needed, have product container or label at hand.

P210: Keep away from heat, hot surfaces, sparks, open flames and other ignition sources. No smoking.

P260: Do not breathe vapours.

P280: Wear protective clothing, eye protection, face protection, protective gloves.

P301+P310 - IF SWALLOWED: Immediately call a doctor.

P331: Do NOT induce vomiting. P501 - Dispose of contents and container to hazardous or special waste collection point, in accordance with local, regional, national and/or international regulation.

SECTION 3: Composition/information on ingredients

Substance type: UVCB

CAS-No.: 1330-20-7 EC-No.: 215-535-7 EC Index-No.: 601-022-00-9 REACH-no: 01-2119488216-32	100%
---	------

SECTION 4: First aid measures

4.1 General Advice

Seek medical attention or call a poison center if feeling unwell.

Inhalation

Move the person to fresh air and keep them comfortable.

Seek medical attention if symptoms persist.

Skin Contact

Remove contaminated clothing.

Rinse skin thoroughly with water or shower.

If irritation occurs, get medical advice.

Eye Contact

Rinse eyes with plenty of water as a precaution.



XYLENE

Safety Data Sheet

According to Regulation (EC) No. 1907/2006 (REACH) with its Amendment Regulation (EC) No. 1272/2008 (CLP) and EU 2020/878

Printing Date 18. 09. 2025

Version Number 01

Revision: 18. 09. 2025

Ingestion

Rinse mouth with water; do NOT induce vomiting.

Seek immediate medical attention.

4.2 Symptoms and Effects

General: May damage organs with prolonged or repeated exposure.

Inhalation: May cause respiratory irritation, coughing, dizziness, headache, nausea, or shortness of breath.

Skin: Harmful in contact, may cause irritation, redness, itching, blistering, or cracking.

Eyes: May cause serious irritation, redness, itching, or tearing.

Ingestion: May cause nausea or vomiting; harmful if swallowed.

4.3 Special Treatment Treat symptomatically

SECTION 5: Firefighting measures

5.1 Extinguishing Media

Suitable: Dry chemical, CO₂, dry sand, or alcohol-resistant foam.

Unsuitable: Avoid using a heavy water stream.

5.2 Special Hazards

Fire Hazard: Flammable liquid and vapour; vapours heavier than air may travel and ignite at a distance. Heating can cause fire or explosion.

Explosion Risk: Vapours may form explosive mixtures with air.

Hazardous Decomposition: Carbon monoxide, carbon dioxide, and toxic fumes may be released.

5.3 Firefighting Instructions

Precautions: Stop leaks if safe; cool exposed containers with water spray. Prevent contaminated water from entering the environment.

Instructions: Evacuate area; use water mist for cooling only.

Protection: Firefighters must wear full protective gear and self-contained breathing apparatus.

SECTION 6: Accidental release measures

6.1 General Measures

Evacuate the area. Avoid static discharge and ignition sources.

Non-Emergency Personnel

Stay upwind. Avoid breathing vapours or contact with skin/eyes.

Ventilate the area; eliminate all flames, sparks, and ignition sources.

Emergency Responders

Wear protective clothing, gloves, goggles, and a respirator with filter type A.

6.2 Environmental Precautions

Prevent entry into drains, surface water, or groundwater.

6.3 Containment & Cleanup

Contain spills with non-combustible materials such as sand or earth.

Absorb liquids with inert material; dispose of residues at approved facilities.



XYLENE

Safety Data Sheet

According to Regulation (EC) No. 1907/2006 (REACH) with its Amendment Regulation (EC) No. 1272/2008 (CLP) and EU 2020/878

Printing Date 18. 09. 2025

Version Number 01

Revision: 18. 09. 2025

SECTION 7: Handling and storage

7.1 Safe Handling

Keep away from heat, sparks, flames, and hot surfaces. No smoking.
Use explosion-proof and non-sparking tools; ground containers to prevent static discharge.
Ensure good ventilation; avoid inhaling vapours, mist, or fumes.
Wear appropriate protective equipment; prevent contact with skin, eyes, and clothing.
Wash hands after handling; launder contaminated clothing before reuse.
Do not eat, drink, or smoke while using this product.

7.2 Storage Conditions

Store in original, tightly closed containers in a cool, well-ventilated area.
Keep away from heat sources, strong oxidizers, and acids.

7.3 Specific End Use(s)

No additional information available.

SECTION 8: Exposure Controls / Personal Protection

8.1 Control Parameters

Xylene (CAS 1330-20-7):

Ireland OEL: TWA 221 mg/m³ (50 ppm), STEL 442 mg/m³ (100 ppm)

UK WEL: TWA 220 mg/m³ (50 ppm), STEL 441 mg/m³ (100 ppm)

Biological Limit (UK): 650 mmol/mol Creatinine (methyl hippuric acid, urine, post-shift)

DNEL (Workers):

Acute (inhalation): 289 mg/m³

Long-term (inhalation): 77 mg/m³

Long-term (dermal): 180 mg/kg bw/day

DNEL (General Population):

Acute (inhalation): 174 mg/m³

Long-term (oral): 1.6 mg/kg bw/day

Long-term (inhalation): 14.8 mg/m³

Long-term (dermal): 108 mg/kg bw/day

PNEC:

Freshwater/Marine: 0.327 mg/l

Sediment: 12.46 mg/kg dwt

Soil: 2.31 mg/kg dwt

STP: 6.58 mg/l

8.2 Exposure Controls

Engineering Controls

Ensure adequate ventilation in all work areas, use explosion-proof equipment.

Eye Protection: Safety glasses with side shields (EN 166).





XYLENE

Safety Data Sheet

According to Regulation (EC) No. 1907/2006 (REACH) with its Amendment Regulation (EC) No. 1272/2008 (CLP) and EU 2020/878

Printing Date 18. 09. 2025

Version Number 01

Revision: 18. 09. 2025

Skin Protection: Protective clothing; gloves (Nitrile, Butyl, PVC) with ≥ 0.44 mm thickness, ≥ 240 min breakthrough time (EN 374-2).

Respiratory Protection: Aerosol mask with ABEK filter for vapour/liquid particles (EN 14387, EN 143).

Environmental Controls: Prevent release into the environment.



SECTION 9: Physical and chemical properties

9.1 Primary physical and chemical properties

Physical state	Liquid
Colour:	Colourless
Odour:	Aromatic
Odour threshold	Not determined
Molecular mass	106.2 g/mol
Melting point:	-95 °C to 13°C
Freezing point	Not determined
Boiling point	138°C
Flammable	Not determined
Lower explosion limit	1 vol %
Upper explosion limit	7.1 vol %
Flash point	> 23 °C
Auto-ignition temperature	432 – 528 °C
Decomposition temperature	Not determined



XYLENE

Safety Data Sheet

According to Regulation (EC) No. 1907/2006 (REACH) with its Amendment Regulation (EC) No. 1272/2008 (CLP) and EU 2020/878

Printing Date 18. 09. 2025

Version Number 01

Revision: 18. 09. 2025

pH	7
Viscosity kinematic	Not determined
Solubility	Water: 106 mg/l
Partition coefficient n-octanol/water (Log Kow)	Not determined
Partition coefficient n-octanol/water (Log Pow)	3.1
Vapour pressure Vapour pressure at 50°C	6.5 – 9.5 hPa Not determined
Density (20°C)	0.86 – 0.88 kg/l
Relative density Relative vapour density at 20°C	Not determined Not determined
Particle characteristics	Not determined

9.2 Other Information No further relevant information available.

SECTION 10: Stability and reactivity

Reactivity: Flammable liquid and vapour

Stability: May generate flammable/explosive vapour-air mixtures.

Hazardous Reactions: Stable under normal use.

Avoid: Heat, sparks, flames, ignition sources. No smoking.

Incompatibilities: Strong acids, oxidizing agents.

Decomposition Products: None expected under normal conditions.

SECTION 11: Toxicological information

Acute Toxicity:

- Oral: Not classified; Xylene LD50 (rat): 3523 mg/kg
- Dermal: Harmful in contact with skin; LD50 (rabbit): 12126 mg/kg; LD50 >5000 mg/kg
- Inhalation: Harmful if inhaled; LC50 (rat, dust/mist): >10000 mg/l

Skin Corrosion/Irritation: Causes skin irritation (pH 7)

Eye Damage/Irritation: Causes serious eye damage (pH 7).

Respiratory/Skin Sensitisation: Not classified



XYLENE

Safety Data Sheet

According to Regulation (EC) No. 1907/2006 (REACH) with its Amendment Regulation (EC) No. 1272/2008 (CLP) and EU 2020/878

Printing Date 18. 09. 2025

Version Number 01

Revision: 18. 09. 2025

Mutagenicity: Not classified

Carcinogenicity: Not classified

Reproductive Toxicity: Not classified

STOT – Single Exposure: May cause respiratory irritation

STOT – Repeated Exposure: May cause organ damage with prolonged exposure; LOAEL (oral, rat, 90 days): 150 mg/kg (OECD 408, EPA OPP 82-1)

Aspiration Hazard: May be fatal if swallowed and enters airways

Other Hazards: No additional information available

SECTION 12: Ecological information

12.1 Toxicity

Product not classified as harmful to aquatic life or the environment.

LC50 (96h)	2.6–4.1 mg/l (Fish) (<i>Oncorhynchus mykiss</i>)
EC50	1–3.4 mg/l (Crustacea) (<i>Ceriodaphnia dubia</i>)
EC50 (72h)	2.2 mg/l (Algae)
LOEC (21d)	3.16 mg/l (<i>Daphnia magna</i>)
NOEC (56d)	>1.3 mg/l (Fish)
NOEC	0.96 mg/l (Crustacea)
EC10	0.44 mg/l (Algae)

12.2 Persistence & Degradability Not readily biodegradable; no additional data available.

12.3 Bioaccumulation Xylene log Pow: 3.1 (Potential for bioaccumulation).

12.4 Mobility in Soil No data available.

12.5 PBT / vPvB Assessment No data available.

12.6 Endocrine Disruption No data available.

12.7 Other Effects No data available.

SECTION 13: Disposal considerations

Waste Treatment: Dispose of product and container according to local regulations and licensed waste handler instructions.

Additional Information: Containers may contain flammable vapours; handle with care.



XYLENE

Safety Data Sheet

According to Regulation (EC) No. 1907/2006 (REACH) with its Amendment Regulation (EC) No. 1272/2008 (CLP) and EU 2020/878

Printing Date 18. 09. 2025

Version Number 01

Revision: 18. 09. 2025

SECTION 14: Transport information

UN number or ID number ADR, IMDG, IATA, ADN, RID	UN 1307
UN proper shipping name ADR, IMDG, IATA, ADN, RID	XYLENES
Transport Hazard Class ADR, IMDG, IATA, ADN, RID 	3 (Flammable liquids)
Transport Details ADR IMDG IATA ADN/ RID	UN 1307 XYLENES, 3, III, (D/E) UN 1307 XYLENES, 3, III (23°C c.c.), not a marine pollutant UN 1307 XYLENES, 3, III UN 1307 XYLENES, 3, III
Packing Group ADR, IMDG, IATA, ADN, RID	III
Environmental Hazards: ADR, IMDG, IATA, ADN, RID	Not classified as dangerous for the environment; not a marine pollutant.
Special Transport Provisions	
Limited quantities	5 L
Excepted quantities	E1



XYLENE

Safety Data Sheet

According to Regulation (EC) No. 1907/2006 (REACH) with its Amendment Regulation (EC) No. 1272/2008 (CLP) and EU 2020/878

Printing Date 18. 09. 2025

Version Number 01

Revision: 18. 09. 2025

Packing instructions:	P001, IBC03, LP01, R001
Tank instructions:	T2, TP1
Flash Point:	23–30°C (Closed cup)
Road / Rail (ADR / RID)	
Tunnel Restriction Code:	D/E
Transport Category:	3
Hazard Identification Number:	30
Mixed Packing Provisions:	MP19
Tank Code:	LGBF
Sea Transport (IMDG)	
Marine Pollutant:	No
EmS:	F-E (Fire), S-D (Spillage)
Stowage Category:	A
Explosive Limits:	1.1% – 7%
Properties:	Immiscible with water
Air Transport (IATA)	
Passenger Aircraft: Limited Quantity: Packing Instruction:	Y344, Max: 10 L 355, Max: 60 L



XYLENE

Safety Data Sheet

According to Regulation (EC) No. 1907/2006 (REACH) with its Amendment Regulation (EC) No. 1272/2008 (CLP) and EU 2020/878

Printing Date 18. 09. 2025

Version Number 01

Revision: 18. 09. 2025

Cargo Aircraft: Packing Instruction	366, Max: 220 L
Special Provisions:	A3
ERG Code	3L
Inland Waterway Transport (ADN)	
Carriage Permitted:	T
Required Equipment:	PP, EX, A
Ventilation:	VE01
Overland Transport (ADR)	
Mixed Packing Provisions:	MP19
Tank Code:	LGBF
Vehicle for Tank Carriage:	FL
Package Provisions:	V12
Operational Provisions:	S2
Markings:	Orange Plates 
EAC Code:	3Y
Maritime transport (IMO instrument)	Not determined



XYLENE

Safety Data Sheet

According to Regulation (EC) No. 1907/2006 (REACH) with its Amendment Regulation (EC) No. 1272/2008 (CLP) and EU 2020/878

Printing Date 18. 09. 2025

Version Number 01

Revision: 18. 09. 2025

SECTION 15: Regulatory Information

REACH (Annex XVII, XIV, SVHC): Not listed

PIC, POP, Ozone, Explosives & Drug Precursors Regulations: No substances listed

National Regulations: No additional information

Chemical Safety Assessment: Not performed

SECTION 16: Other information

The information provided here reflects our current understanding. It does not serve as a guarantee of specific product properties, nor does it create a legally binding agreement.

Department issuing SDS:



OWL WATERPROOFING SOLUTIONS

135 Slaney Road, Dublin Industrial Estate

Glasnevin, Dublin 11

Tel: +353 01 830 2250

Email: info@owlwaterproofing.co.uk

Website: www.owlwaterproofing.co.uk

Version number of previous version: 0

Abbreviations and acronyms:

ADN: European Agreement concerning the International Carriage of Dangerous Goods by Inland Waterways

ADR: Accord relatif au transport international des marchandises dangereuses par route (European Agreement Concerning the International Carriage of Dangerous Goods by Road)

ATE: Acute Toxicity Estimate

BCF: Bioconcentration factor

BLV: Biological limit value

BOD: Biochemical oxygen demand (BOD)

COD: Chemical oxygen demand (COD)

DMEL: Derived Minimal Effect level

DNEL: Derived-No Effect Level

EC-No.: European Community number

EC50: Median effective concentration

EN: European Standard

IARC: International Agency for Research on Cancer

IATA: International Air Transport Association

IMDG: International Maritime Code for Dangerous Goods

LC50: Lethal concentration, 50 percent

LD50: Lethal dose, 50 percent

LOAEL: Lowest Observed Adverse Effect Level

NOAEC: No-Observed Adverse Effect Concentration

NOAEL: No-Observed Adverse Effect Level

NOEC: No-Observed Effect Concentration

OECD: Organisation for Economic Co-operation and Development

OEL: Occupational Exposure Limit

PBT: Persistent Bioaccumulative Toxic

PNEC: Predicted No-Effect Concentration

RID: Regulations concerning the International Carriage of Dangerous Goods by Rail

SDS: Safety Data Sheet

STP: Sewage treatment plant

ThOD: Theoretical oxygen demand (ThOD)

TLM: Median Tolerance Limit

PBT: Persistent, Bioaccumulative and Toxic



XYLENE

Safety Data Sheet

According to Regulation (EC) No. 1907/2006 (REACH) with its
Amendment Regulation (EC) No. 1272/2008 (CLP) and EU 2020/878

Printing Date 18. 09. 2025

Version Number 01

Revision: 18. 09. 2025

SVHC: Substances of Very High Concern

VOC: Volatile Organic Compounds

CAS-No.: Chemical Abstract Service number

N.O.S.: Not Otherwise Specified

ED: Endocrine disrupting properties

vPvB: very Persistent and very Bioaccumulative

Acute Tox. 4 (Dermal): Acute toxicity (dermal), Category 4

Acute Tox. 4 (Inhalation): Acute toxicity (inhal.), Category 4

Asp. Tox. 1: Aspiration hazard, Category 1

Eye Irrit. 2: Serious eye damage/eye irritation, Category 2

Flam. Liq. 3: Flammable liquids, Category 3

H226: Flammable liquid and vapour.

H304: May be fatal if swallowed and enters airways.

H312: Harmful in contact with skin.

H315: Causes skin irritation.

H319: Causes serious eye irritation.

H332: Harmful if inhaled.

H335: May cause respiratory irritation.

H373: May cause damage to organs through prolonged or repeated exposure.

Skin Irrit. 2: Skin corrosion/irritation, Category 2

STOT RE 2: Specific target organ toxicity – Repeated exposure, Category 2

STOT SE 3: Specific target organ toxicity – Single exposure, Category 3, Respiratory tract irritation

*** Data compared to the previous version altered.**